

# OPTONICA LED

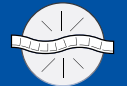
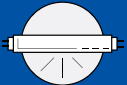

**5**  
Year  
Warranty

Catalogue Edition 2.0 **2019**

# OPTONICA

OPTONICA LED is one of the fastest growing LED lighting companies in Europe. We constantly offer our partners a carefully selected portfolio of products with proven quality that meet even the most discriminating requirements. Full range of lights and fixtures for domestic or industrial applications, our products are designed to fit any demand. Developing a vast network of distributors and offices in major European countries such as United Kingdom, Germany, Austria, Spain, Bulgaria and Hungary, our products are easily accessible.

OPTONICA LED offers latest-generation, energy efficient lighting, with no harmful emissions and which is completely recyclable. We believe in caring for the future generations. Please help us save the planet for a more beautiful and clean tomorrow. Let's make the right choice and illuminate the future - together!

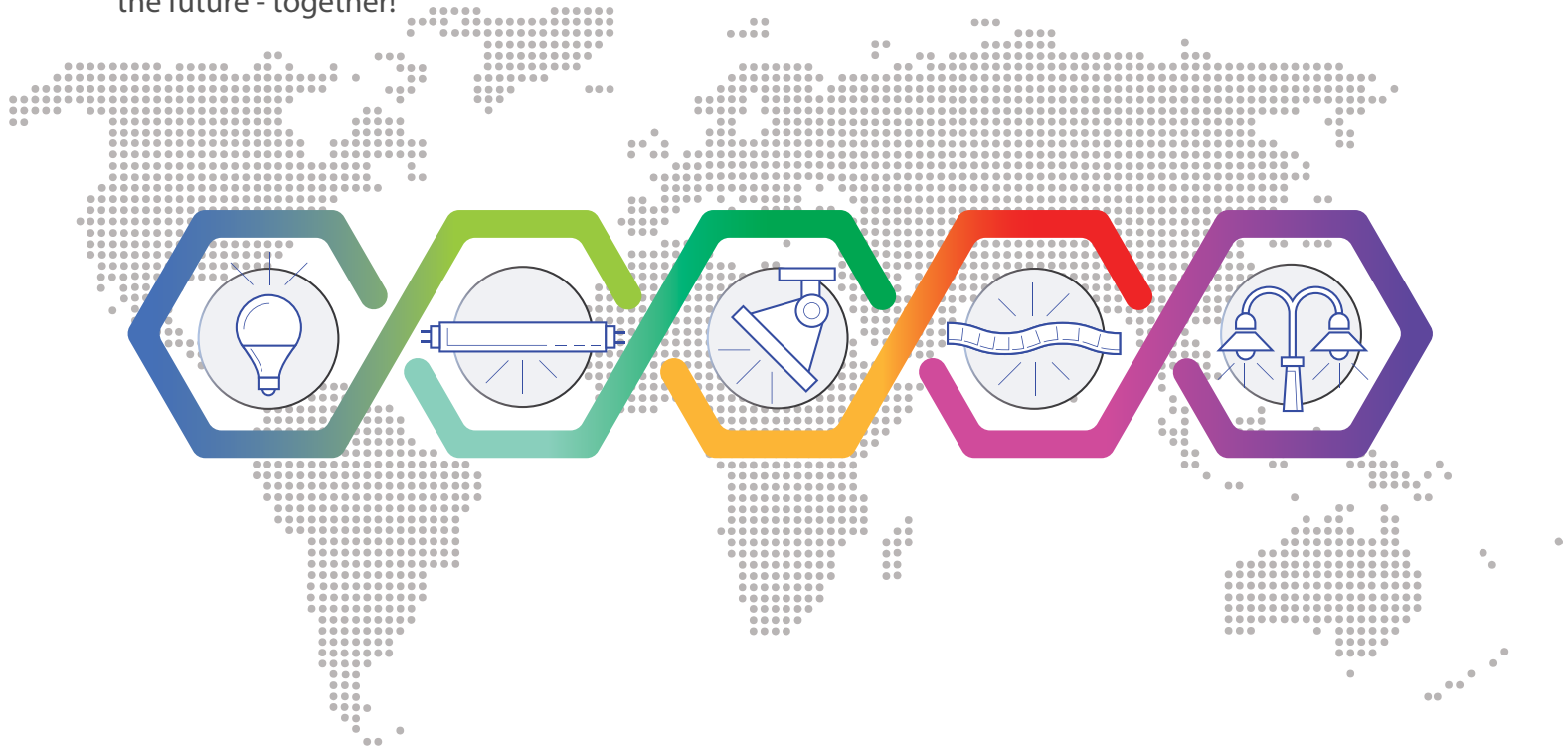

# CONTENTS

## LED Spots and Bulbs

04-41



## LED Ceiling Light & Luxury Pendants

68-87



## LED Power Supplies

148-157



## LED Wall Washers

204-207



## LED Tubes

42-48



## LED Panels and Mini Modules

88-108



## LED Controllers and Accessories

158-165



## LED Wall & Step Lights

208-221



## LED Fixture and Batten Lights

49-53



## LED Downlights

109-121



## LED Linear & Track Lights

166-173



## LED Outdoor & Garden Lights

222-233



## LED Emergency Lights

54-57



## LED Strips

122-141



## LED Floodlights

174-189



## LED Motion Sensors

234-241



## LED Surface Panels

58-67



## LED Flex Neon & SMD Modules

142-147



## LED Industrial & Street Lights

190-203



## LED Displays

242-253





E27



IP20



5 Years  
Warranty

**7W-18W E27 Premium**  
LED Bulbs E27

**7W** **A60**  
Lumens

**10W** **A60**  
Lumens

**12W** **A60**  
Lumens

**15W** **A65**  
Lumens

**18W** **A70**  
Lumens

- SKU No.**
- Light Color**
- Watts**
- Input Voltage**
- Flux**
- Beam Angle**
- CRI**
- IP Rating**
- Dimension**

SP1715/SP1716/SP1717
6000K/4500K/2700K
7W
AC : 175-265V
560lm
270°
Ra>80
IP20
ø60x100 mm

SP1718/SP1719/SP1720
6000K/4500K/2700K
10W
AC : 175-265V
806lm
270°
Ra>80
IP20
ø60x109 mm

SP1721/SP1722/SP1723
6000K/4500K/2700K
12W
AC : 175-265V
1055lm
270°
Ra>80
IP20
ø60x112 mm

SP1724/SP1725/SP1726
6000K/4500K/2700K
15W
AC : 175-265V
1320lm
270°
Ra>80
IP20
ø65x127 mm

SP1748/SP1749/SP1750
6000K/4500K/2700K
18W
AC : 175-265V
1700lm
270°
Ra>80
IP20
ø70x145 mm

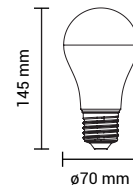
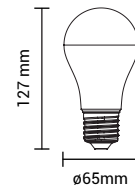
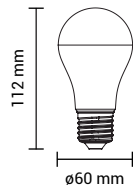
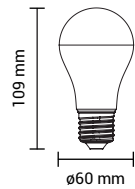
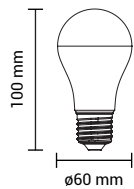

Color Temperature

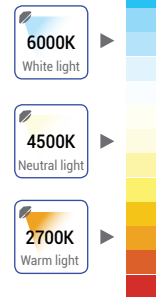





**10W-15W E27 Premium**  
LED Bulbs A60 - 3pcs



E27



IP20



5 Years  
Warranty

**10W** **806**  
Lumens

**12W** **1055**  
Lumens

**15W** **1320**  
Lumens

- SKU No.**
- Light Color**
- Watts**
- Input Voltage**
- Flux**
- Beam Angle**
- CRI**
- IP Rating**
- Dimension**

SP1727/SP1728/SP1729
6000K/4500K/2700K
10W
AC : 175-265V
806lm
270°
Ra>80
IP20
ø60x109 mm

SP1730/SP1731/SP1732
6000K/4500K/2700K
12W
AC : 175-265V
1055lm
270°
Ra>80
IP20
ø60x112mm

SP1733/SP1734/SP1735
6000K/4500K/2700K
15W
AC : 175-265V
1320lm
270°
Ra>80
IP20
ø65x127mm

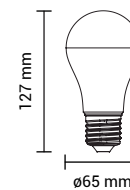
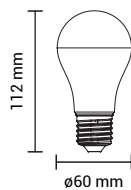
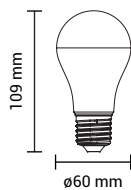

Color Temperature

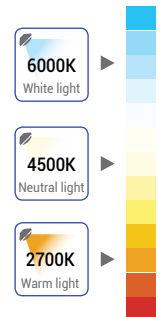



E27



IP20



270°

**7W-18W**

LED Bulbs E27

**7W**  **A60**  
Lumens

**10W**  **A60**  
Lumens

**12W**  **A60**  
Lumens

**15W**  **A65**  
Lumens

**18W**  **A70**  
Lumens

 **SKU No.**

SP1824/SP1825/SP1826

 **Light Color**

6000K/4500K/2700K

 **Watts**

7W

 **Input Voltage**

AC : 175-265V

 **Flux**

560lm

 **Beam Angle**

270°

 **CRI**



Ra&gt;80

 **IP Rating**

IP20

 **Dimension**

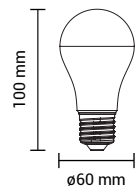
ø60x100 mm

 **SKU No.**

SP1827/SP1828/SP1829

 **Light Color**

6000K/4500K/2700K

 **Watts**

10W

 **Input Voltage**

AC : 175-265V

 **Flux**

800lm

 **Beam Angle**

270°

 **CRI**



Ra&gt;80

 **IP Rating**

IP20

 **Dimension**

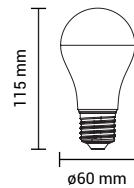
ø60x115 mm

 **SKU No.**

SP1831/SP1832/SP1833

 **Light Color**

6000K/4500K/2700K

 **Watts**

12W

 **Input Voltage**

AC : 175-265V

 **Flux**

960lm

 **Beam Angle**

270°

 **CRI**



Ra&gt;80

 **IP Rating**

IP20

 **Dimension**

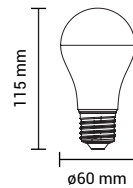
ø60x115mm

 **SKU No.**

SP1835/SP1836/SP1837

 **Light Color**

6000K/4500K/2700K

 **Watts**

15W

 **Input Voltage**

AC : 175-265V

 **Flux**

1200lm

 **Beam Angle**

270°

 **CRI**

Ra&gt;80

 **IP Rating**

IP20

 **Dimension**

ø65x122 mm

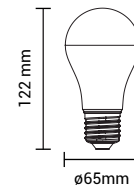
 **SKU No.**

SP1881/SP1882/SP1883

 **Light Color**

6000K/4500K/2700K

 **Watts**

18W

 **Input Voltage**

AC : 175-265V

 **Flux**

1440lm

 **Beam Angle**

270°

 **CRI**

Ra&gt;80

 **IP Rating**

IP20

 **Dimension**

ø70x134 mm

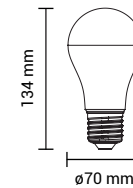

Color Temperature

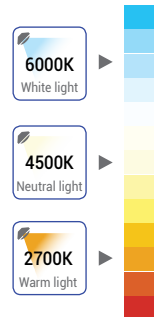



**10W-12W E27**  
LED Bulbs A60



**12W-15W E27**  
LED Bulbs G95 ,G120



E27



IP20

**10W** **800** **DIMMABLE**  
Lumens

**12W** **960** **DIMMABLE**  
Lumens

**12W** **1050** **DIMMABLE**  
Lumens

**15W** **1380** **DIMMABLE**  
Lumens

- SKU No.**
- Light Color**
- Watts**
- Input Voltage**
- Flux**
- Beam Angle**
- CRI**
- IP Rating**
- Dimension**

SP1849/SP1850/SP1830	SP1851/SP1852/SP1834
6000K/4500K/2700K	6000K/4500K/2700K
10W	12W
AC : 175-265V	AC : 175-265V
800lm	960lm
240°	240°
Ra>80	Ra>80
IP20	IP20
ø60x110 mm	ø60x120 mm

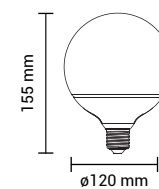
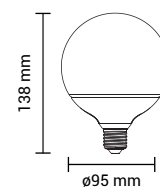
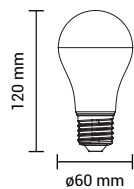
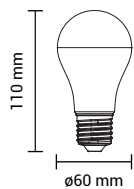

Color Temperature

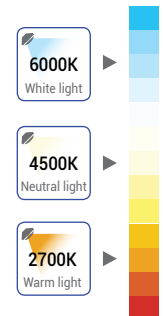



E27



IP20



270°

**15W-18W E27**

LED Bulbs G95 ,G120

**12W-15W E27 Premium**

LED Bulbs G95 ,G120

**15W** **1200** G95  
Lumens

**15W** **1200** G120  
Lumens

**18W** **1440**  
Lumens

**12W** **1050**   
Lumens Warranty

**15W** **1380**   
Lumens Warranty

- SKU No.**
- Light Color**
- Watts**
- Input Voltage**
- Flux**
- Beam Angle**
- CRI**
- IP Rating**
- Dimension**

SP1841/SP1842/SP1843
6000K/4500K/2700K
15W
AC : 175-265V
1200lm
270°
Ra>80
IP20
ø95x138 mm

SP1845/SP1846/SP1847
6000K/4500K/2700K
15W
AC : 175-265V
1200lm
270°
Ra>80
IP20
ø120x155 mm

SP1884/SP1885/SP1886
6000K/4500K/2700K
18W
AC : 175-265V
1440lm
270°
Ra>80
IP20
ø125x172mm

SP1742/SP1743/SP1744
6000K/4500K/2700K
12W
AC : 175-265V
1050lm
270°
Ra>80
IP20
ø95x138 mm

SP1745/SP1746/SP1747
6000K/4500K/2700K
15W
AC : 175-265V
1380lm
270°
Ra>80
IP20
ø120x155 mm

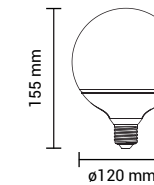
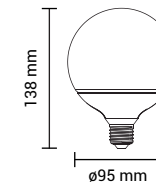
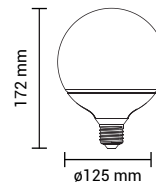
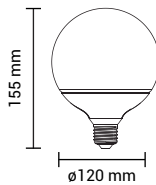
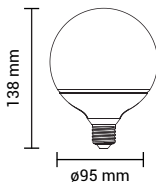

Color Temperature

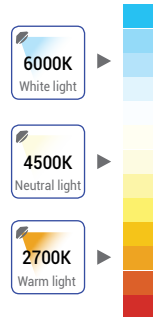

**4W-6W E27 Premium**  
LED Bulbs G45

5  
Years

Warranty



**4W-6W E27**  
LED Bulbs G45

2  
Years

Warranty



E27



IP20



180°

**4W** 320  
Lumens

**6W** 480  
Lumens

**4W** 320  
Lumens

**6W** 480  
Lumens

- SKU No.**
- Light Color**
- Watts**
- Input Voltage**
- Flux**
- Beam Angle**
- CRI**
- IP Rating**
- Dimension**

SP1736/SP1737/SP1738	SP1739/SP1740/SP1741
6000K/4500K/2700K	6000K/4500K/2700K
4W	6W
AC : 175-265V	AC : 175-265V
320lm	480lm
180°	180°
Ra>80	Ra>80
IP20	IP20
ø45x75 mm	ø45x75 mm

SP1838/SP1839/SP1840	SP1816/SP1817/SP1818
6000K/4500K/2700K	6000K/4500K/2700K
4W	6W
AC : 175-265V	AC : 175-265V
320lm	480lm
180°	180°
Ra>80	Ra>80
IP20	IP20
ø45x75 mm	ø45x75 mm

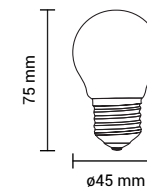
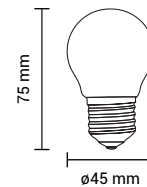
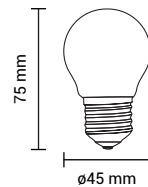
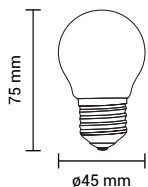

Color Temperature

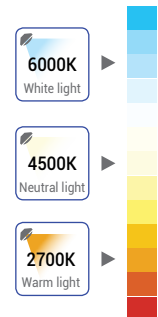





**25W-45W E27**  
LED Bulbs HIGH POWER



E27



IP20











270°

**25W**  **T100**  
Lumens

**35W**  **T120**  
Lumens

**45W**  **T140**  
Lumens

-  **SKU No.**
-  **Light Color**
-  **Watts**
-  **Input Voltage**
-  **Flux**
-  **Beam Angle**
-  **CRI**
-  **IP Rating**
-  **Dimension**

SKU No.	SP1891/SP1892
Light Color	6000K/4500K
Watts	25W
Input Voltage	AC : 175-265V
Flux	2300lm
Beam Angle	270°
CRI	Ra>80
IP Rating	IP20
Dimension	ø100x190 mm

SKU No.	SP1894/SP1895
Light Color	6000K/4500K
Watts	35W
Input Voltage	AC : 175-265V
Flux	3200lm
Beam Angle	270°
CRI	Ra>80
IP Rating	IP20
Dimension	ø120x200mm

SKU No.	SP1897/SP1898
Light Color	6000K/4500K
Watts	45W
Input Voltage	AC : 175-265V
Flux	4100lm
Beam Angle	270°
CRI	Ra>80
IP Rating	IP20
Dimension	ø140x230mm

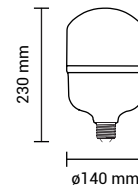
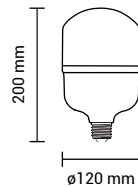
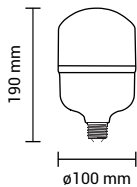

Color Temperature

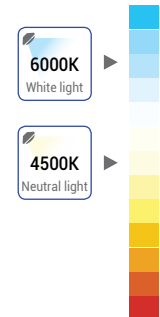

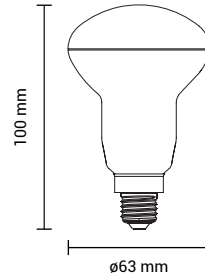

SKU No.	SP1876/SP1877/SP1878
Light Color	6000K/4500K/2800K
Watts	6W
Input Voltage	AC : 220-265V
Flux	480lm
Beam Angle	200°
CRI	Ra>80
IP Rating	IP20
Dimension	ø63x100 mm

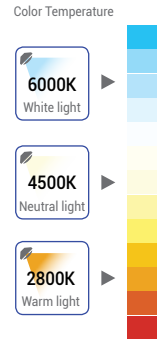

**6W E27**  
LED BULB R63

480 Lumens  
 E27  
 200°  
 IP20

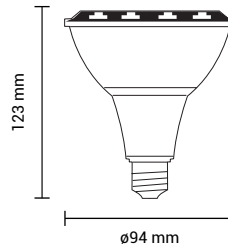

SKU No.	SP1520/SP1521/SP1522
Light Color	6000K/4500K/2800K
Watts	30W
Input Voltage	AC : 220-240V
Flux	2300lm
Beam Angle	24°
CRI	Ra>80
IP Rating	IP20
Dimension	ø94x123 mm

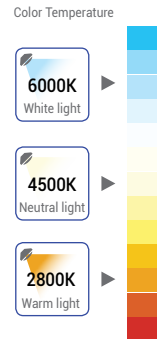

**30W E27**  
LED BULB PAR30

2300 Lumens  
 E27  
 24°  
 IP20



**LED BULBS GOLDEN GLASS**



Innovative line of half-glass covered bulbs combine the classic retro appearance with modern power-saving technology and creating a cosy ambience in both homes, villa or restaurants and bars.

Features:

- Up to 80% power saving impact
- 2500K warm white light
- Half silver or half golden cover
- E27 socket
- Stylish retro look
- Standard bulb head – A60 or G95

Application:

- Home use on standard sockets
- Outdoor use in enclosed fixtures
- Discrete or additional lighting



**LED BULBS E27**  
GOLDEN GLASS  
FILAMENT

**8W** **PS160**  
Lumens

**8W** **BD200**  
Lumens

**8W** **G200**  
Lumens

**8W** **MS200**  
Lumens

- SKU No.
- Light Color
- Watts
- Input Voltage
- Flux
- Beam Angle
- CRI
- IP Rating
- Dimension

SKU No.	SP1790	SP1791	SP1792	SP1793
Light Color	1800K GOLDEN	1800K GOLDEN	1800K GOLDEN	1800K GOLDEN
Watts	8W	8W	8W	8W
Input Voltage	AC : 220-265V	AC : 175-265V	AC : 175-265V	AC : 175-265V
Flux	810lm	810lm	810lm	810lm
Beam Angle	270°	270°	270°	270°
CRI	Ra>80	Ra>80	Ra>80	Ra>80
IP Rating	IP20	IP20	IP20	IP20
Dimension	ø160x315 mm	ø200x410 mm	ø200x300 mm	ø200x210 mm

Color Temperature





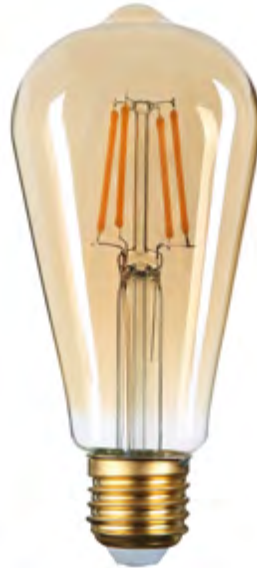

E27



270°



IP20

**LED BULBS E27**  
GOLDEN GLASS  
FILAMENT

**4W**  **G95**  
Lumens









SKU No.	SP1794
Light Color	2500K GOLDEN
Watts	4W
Input Voltage	AC : 220-240V
Flux	400lm
Beam Angle	270°
CRI	Ra>80
IP Rating	IP20
Dimension	ø95x135 mm

**4W**  **ST64**  
Lumens

SKU No.	SP1795
Light Color	2500K GOLDEN
Watts	4W
Input Voltage	AC : 220-240V
Flux	400lm
Beam Angle	270°
CRI	Ra>80
IP Rating	IP20
Dimension	ø64x140 mm

**8W**  **A60**  
Lumens

SKU No.	SP1796
Light Color	2500K GOLDEN
Watts	8W
Input Voltage	AC : 220-240V
Flux	700lm
Beam Angle	270°
CRI	Ra>80
IP Rating	IP20
Dimension	ø60x105 mm

-  SKU No.
-  Light Color
-  Watts
-  Input Voltage
-  Flux
-  Beam Angle
-  CRI
-  IP Rating
-  Dimension

Color Temperature

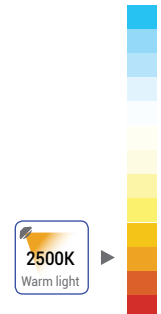



**LED BULBS E27**

HALF GOLDEN / SILVER GLASS

FILAMENT

**4W** **G95**  
Lumens

**7W** **G95**  
Lumens

**4W** **A60**  
Lumens

**7W** **A60**  
Lumens

- SKU No.**
- Body Color**
- Light Color**
- Watts**
- Input Voltage**
- Flux**
- Beam Angle**
- CRI**
- IP Rating**
- Dimension**

SKU No.	SP1887/SP1889	SP1888/SP1890	SP1879/SP1893	SP1880/SP1896
Body Color	SILVER/GOLDEN	SILVER/GOLDEN	SILVER/GOLDEN	SILVER/GOLDEN
Light Color	2700K/2700K	2700K/2700K	2700K/2700K	2700K/2700K
Watts	4W	7W	4W	7W
Input Voltage	AC : 220-220V	AC : 220-220V	AC : 220-220V	AC : 220-220V
Flux	400lm	800lm	400lm	800lm
Beam Angle	180°	180°	180°	180°
CRI	Ra>80	Ra>80	Ra>80	Ra>80
IP Rating	IP20	IP20	IP20	IP20
Dimension	ø95x135 mm	ø95x135 mm	ø60x105 mm	ø60x105 mm

Color Temperature

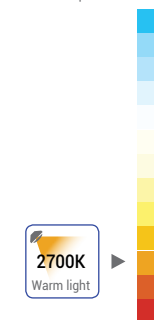

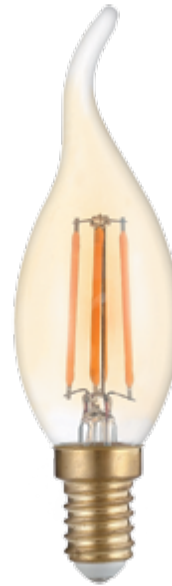

**LED BULBS E14**  
GOLDEN GLASS  
FILAMENT



E14



270°



IP20

**4W** **C35**  
Lumens

SKU No.	SP1490
Light Color	2500K GOLDEN
Watts	4W
Input Voltage	AC : 220-240V
Flux	400lm
Beam Angle	270°
CRI	Ra>80
IP Rating	IP20
Dimension	ø35x98 mm

**4W** **T35**  
Lumens

SKU No.	SP1491
Light Color	2500K GOLDEN
Watts	4W
Input Voltage	AC : 220-240V
Flux	400lm
Beam Angle	270°
CRI	Ra>80
IP Rating	IP20
Dimension	ø35x120 mm

**4W** **G45**  
Lumens

SKU No.	SP1492
Light Color	2500K GOLDEN
Watts	4W
Input Voltage	AC : 220-240V
Flux	400lm
Beam Angle	270°
CRI	Ra>80
IP Rating	IP20
Dimension	ø45x78 mm

- SKU No.
- Light Color
- Watts
- Input Voltage
- Flux
- Beam Angle
- CRI
- IP Rating
- Dimension

Color Temperature

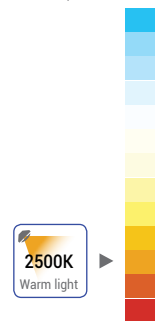



**4W-6.5W E27 Filament**  
LED Bulbs A60



E27



IP20



300°

**4W** 400  
Lumens

**5W** 600  
Lumens

**6W** 600 DIMMABLE  
Lumens

**6.5W** 810  
Lumens

- SKU No.**
- Light Color**
- Watts**
- Input Voltage**
- Flux**
- Beam Angle**
- CRI**
- IP Rating**
- Dimension**

SP1857/SP1858/SP1859	SP1854/SP1855/SP1856	SP1853	SP1873/SP1874/SP1875
6000K/4500K/2700K	6000K/4500K/2700K	2700K	6000K/4500K/2700K
4W	5W	6W	6.5W
AC : 175-265V	AC : 175-265V	AC : 175-265V	AC : 175-265V
400lm	600lm	600lm	810lm
300°	300°	300°	300°
Ra>80	Ra>80	Ra>80	Ra>80
IP20	IP20	IP20	IP20
ø60x100mm	ø60x100 mm	ø60x106 mm	ø60x106 mm

Color Temperature

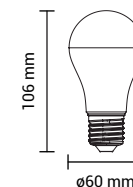
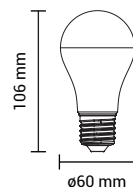
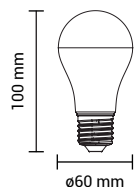
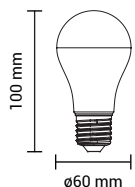
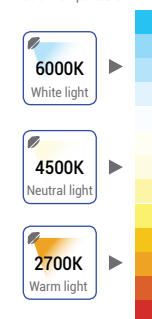



**2W-6.5W E27 Filament**  
LED Bulbs G45,G125



E27



IP20



300°

**2W** **200**  
Lumens

**4W** **400**  
Lumens

**4W** **400**  
Lumens

**6.5W** **810**  
Lumens

- SKU No.**
- Light Color**
- Watts**
- Input Voltage**
- Flux**
- Beam Angle**
- CRI**
- IP Rating**
- Dimension**

SP1864/SP1865/SP1866	SP1867/SP1868/SP1869
6000K/4500K/2700K	6000K/4500K/2700K
2W	4W
AC : 175-265V	AC : 175-265V
200lm	400lm
300°	300°
Ra>80	Ra>80
IP20	IP20
ø45x78 mm	ø45x78 mm

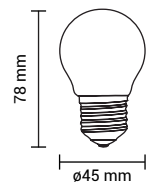
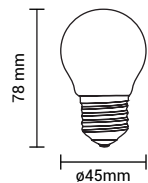

SP1863/SP1862	SP1861/SP1860
4500K/2700K	4500K/2700K
4W	6.5W
AC : 175-265V	AC : 175-265V
400lm	810lm
300°	300°
Ra>80	Ra>80
IP20	IP20
ø125x165 mm	ø125x165 mm

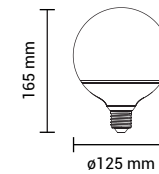
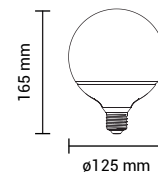



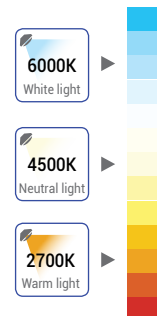



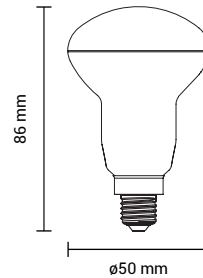

Color Temperature







-  **SKU No.**
-  **Light Color**
-  **Watts**
-  **Input Voltage**
-  **Flux**
-  **Beam Angle**
-  **CRI**
-  **IP Rating**
-  **Dimension**



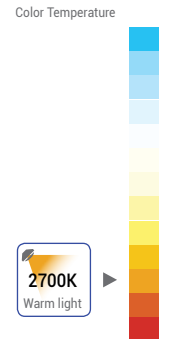



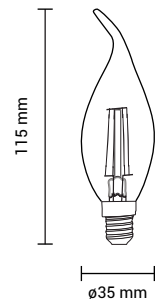

SKU No.	SP1872
Light Color	2700K
Watts	5W
Input Voltage	AC : 175-265V
Flux	600lm
Beam Angle	70°
CRI	Ra>80
IP Rating	IP20
Dimension	ø50x86 mm



**5W E14 Filament**  
LED BULB R50

-  600  
Lumens
-  E14
-  70°
-  IP20



-  **SKU No.**
-  **Light Color**
-  **Watts**
-  **Input Voltage**
-  **Flux**
-  **Beam Angle**
-  **CRI**
-  **IP Rating**
-  **Dimension**

SKU No.	SP1480/SP1481/SP1482
Light Color	6000K/4500K/2700K
Watts	4W
Input Voltage	AC : 175-265V
Flux	400lm
Beam Angle	300°
CRI	Ra>80
IP Rating	IP20
Dimension	ø35x115 mm

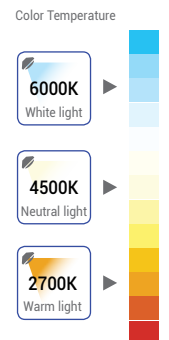

**4W E14 Filament**  
LED BULB C35T

-  400  
Lumens
-  E14
-  300°
-  IP20





**2W-4W E14 Filament**  
LED Bulbs G45,C35



E14



IP20



300°

**2W** **200**  
Lumens

**4W** **400**  
Lumens

**4W** **400**  
Lumens

**4W** **400**   
Lumens DIMMABLE

- SKU No.**
- Light Color**
- Watts**
- Input Voltage**
- Flux**
- Beam Angle**
- CRI**
- IP Rating**
- Dimension**

SKU No.	SP1474/SP1475/SP1476	SP1477/SP1478/SP1479
Light Color	6000K/4500K/2700K	6000K/4500K/2700K
Watts	2W	4W
Input Voltage	AC : 175-265V	AC : 175-265V
Flux	200lm	400lm
Beam Angle	300°	300°
CRI	Ra>80	Ra>80
IP Rating	IP20	IP20
Dimension	ø45x78 mm	ø45x78 mm

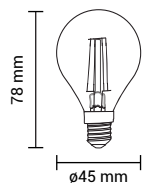
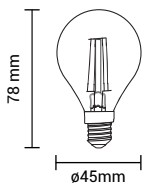

SKU No.	SP1470/SP1471/SP1472	SP1473
Light Color	6000K/4500K/2700K	2700K
Watts	4W	4W
Input Voltage	AC : 175-265V	AC : 175-265V
Flux	400lm	400lm
Beam Angle	300°	300°
CRI	Ra>80	Ra>80
IP Rating	IP20	IP20
Dimension	ø35x98 mm	ø35x98 mm

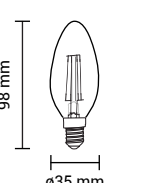
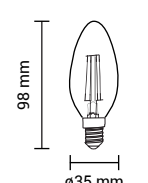

Color Temperature

6000K White light

4500K Neutral light

2700K Warm light



E14



IP20



5 Years  
Warranty

**6W E14 Premium**

LED Bulbs

**6W** **C37**  
Lumens

**6W** **C37T**  
Lumens

**6W** **P45**  
Lumens

**6W** **R50**  
Lumens

- SKU No.**
- Light Color**
- Watts**
- Input Voltage**
- Flux**
- Beam Angle**
- CRI**
- IP Rating**
- Dimension**

SKU No.	SP1780/SP1781/SP1782	SP1751/SP1752/SP1759	SP1753/SP1754/SP1755	SP1756/SP1757/SP1758
Light Color	6000K/4500K/2700K	6000K/4500K/2700K	6000K/4500K/2700K	6000K/4500K/2700K
Watts	6W	6W	6W	6W
Input Voltage	AC : 175-265V	AC : 175-265V	AC : 175-265V	AC : 175-265V
Flux	480lm	480lm	480lm	450lm
Beam Angle	180°	180°	240°	180°
CRI	Ra>80	Ra>80	Ra>80	Ra>80
IP Rating	IP20	IP20	IP20	IP20
Dimension	ø37x100 mm	ø37x125 mm	ø45x78 mm	ø50x90 mm

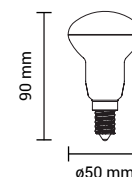
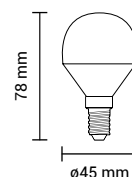
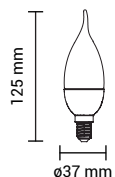
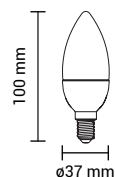

Color Temperature

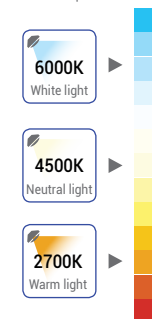



**4W-6W E14**  
LED Bulbs G45



**4W-6W E14**  
LED Bulbs R39,R50



E14











IP20

**4W**  **320**  
Lumens

**6W**  **480**  
Lumens

**4W**  **300**  
Lumens

**6W**  **480**  
Lumens

-  **SKU No.**
-  **Light Color**
-  **Watts**
-  **Input Voltage**
-  **Flux**
-  **Beam Angle**
-  **CRI**
-  **IP Rating**
-  **Dimension**

SKU No.	SP1451/SP1452/SP1453	SP1447/SP1448/SP1449
Light Color	6000K/4500K/2700K	6000K/4500K/2700K
Watts	4W	6W
Input Voltage	AC : 175-265V	AC : 175-265V
Flux	320lm	480lm
Beam Angle	240°	240°
CRI	Ra>80	Ra>80
IP Rating	IP20	IP20
Dimension	ø45x78 mm	ø45x78 mm

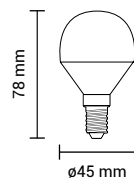
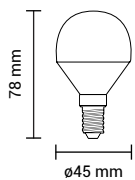

SKU No.	SP1487/SP1488/SP1489	SP1438/SP1439/SP1440
Light Color	6000K/4500K/2700K	6000K/4500K/2700K
Watts	4W	6W
Input Voltage	AC : 175-265V	AC : 175-265V
Flux	300lm	480lm
Beam Angle	200°	180°
CRI	Ra>80	Ra>80
IP Rating	IP20	IP20
Dimension	ø39x68 mm	ø50x85 mm

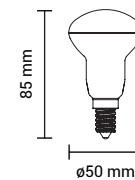
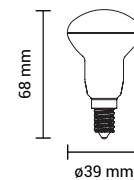

Color Temperature

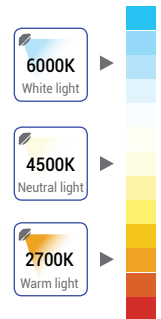



E14



IP20



180°

**3W-6W E14**  
LED Bulb C37

- SKU No.
- Light Color
- Watts
- Input Voltage
- Flux
- Beam Angle
- CRI
- IP Rating
- Dimension

	3W  240 Lumens	4W  320 Lumens	6W  480 Lumens	6W  480 Lumens  DIMMABLE
SKU No.	SP1454/SP1455/SP1456	SP1457/SP1458/SP1459	SP1460/SP1461/SP1462	SP1464/SP1465/SP1463
Light Color	6000K/4500K/2700K	6000K/4500K/2700K	6000K/4500K/2700K	6000K/4500K/2700K
Watts	3W	4W	6W	6W
Input Voltage	AC : 85-265V	AC : 85-265V	AC : 85-265V	AC : 85-265V
Flux	240lm	320lm	480lm	480lm
Beam Angle	180°	180°	180°	180°
CRI	Ra>80	Ra>80	Ra>80	Ra>80
IP Rating	IP20	IP20	IP20	IP20
Dimension	ø37x100 mm	ø37x100mm	ø37x100 mm	ø37x100mm

Color Temperature

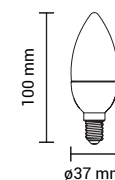
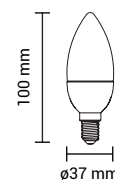
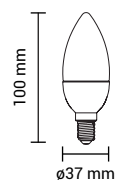
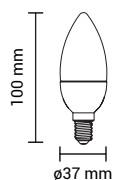
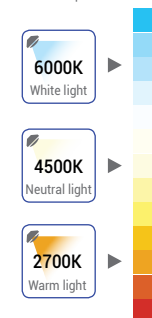



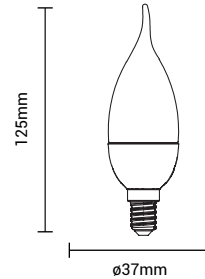

SKU No.	SP1466/SP1467/SP1468
Light Color	6000K/4500K/2700K
Watts	6W
Input Voltage	AC : 175-265V
Flux	480lm
Beam Angle	180°
CRI	Ra>80
IP Rating	IP20
Dimension	ø37x125 mm

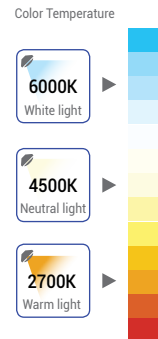

**6W E14**  
LED BULB C37T

480 Lumens  
 E14  
 180°  
 IP20

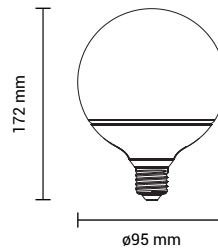

SKU No.	SP1819
Light Color	4500K
Watts	8W+2W Zapper
Input Voltage	AC : 100-265V
Flux	640lm
Beam Angle	180°
CRI	Ra>80
IP Rating	IP20
Dimension	ø95x172 mm

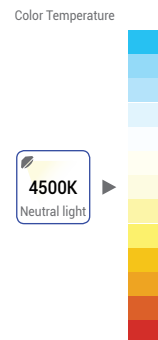

**8W+2W E27**  
LED BULB MOSQUITO ZAPPER

640 Lumens  
 E27  
 180°  
 IP20

**5W-15W**  
LED Bulbs B22



B22



IP20



180°

**5W** **G45**  
Lumens

**7W** **A60**  
Lumens

**10W** **A60**  
Lumens

**12W** **A65**  
Lumens

**15W** **A65**  
Lumens

- SKU No.**
- Light Color**
- Watts**
- Input Voltage**
- Flux**
- Beam Angle**
- CRI**
- IP Rating**
- Dimension**

SKU No.	SP1901/SP1902/SP1903
Light Color	6000K/4500K/2700K
Watts	5W
Input Voltage	AC : 175-265V
Flux	400lm
Beam Angle	180°
CRI	Ra>80
IP Rating	IP20
Dimension	ø45x57 mm

SKU No.	SP1904/SP1905/SP1906
Light Color	6000K/4500K/2700K
Watts	7W
Input Voltage	AC : 175-265V
Flux	560lm
Beam Angle	180°
CRI	Ra>80
IP Rating	IP20
Dimension	ø60x110 mm

SKU No.	SP1907SP1908/SP1909
Light Color	6000K/4500K/2700K
Watts	10W
Input Voltage	AC : 175-265V
Flux	800lm
Beam Angle	180°
CRI	Ra>80
IP Rating	IP20
Dimension	ø60x110mm

SKU No.	SP1911/SP1912/SP1913
Light Color	6000K/4500K/2700K
Watts	12W
Input Voltage	AC : 175-265V
Flux	960lm
Beam Angle	270°
CRI	Ra>80
IP Rating	IP20
Dimension	ø65x110 mm

SKU No.	SP1915/SP1916/SP1917
Light Color	6000K/4500K/2700K
Watts	15W
Input Voltage	AC : 175-265V
Flux	1200lm
Beam Angle	180°
CRI	Ra>80
IP Rating	IP20
Dimension	ø65x110 mm

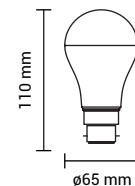
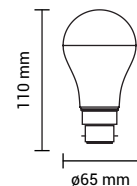
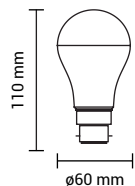
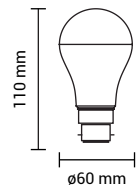
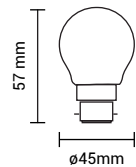

Color Temperature

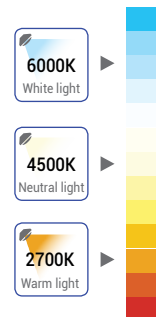



**10W-12W B22**  
LED Bulbs A60



**6W B22**  
LED Bulbs C37



**6W B15**  
LED Bulbs C37



IP20



180°

**10W**   
Lumens DIMMABLE

**12W**   
Lumens DIMMABLE

**6W**   
Lumens

**6W**   
Lumens DIMMABLE

**6W**   
Lumens

- SKU No.**
- Light Color**
- Watts**
- Input Voltage**
- Flux**
- Beam Angle**
- CRI**
- IP Rating**
- Dimension**

SP1910
2700K
10W
AC : 175-265V
800lm
180°
Ra>80
IP20
ø60x110 mm

SP1914
2700K
12W
AC : 175-265V
960lm
180°
Ra>80
IP20
ø65x110 mm

SP1950/SP1951/SP1952
6000K/4500K/2700K
6W
AC : 175-265V
480lm
180°
Ra>80
IP20
ø37x90mm

SP1953
2700K
6W
AC : 175-265V
480lm
180°
Ra>80
IP20
ø37x90 mm

SP1954/SP1955/SP1956
6000K/4500K/2700K
6W
AC : 175-265V
480lm
180°
Ra>80
IP20
ø37x90 mm

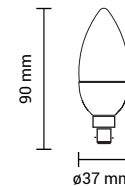
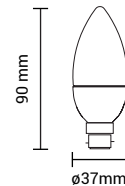
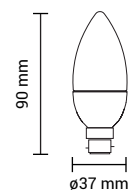
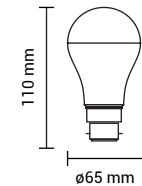
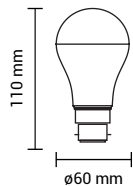

Color Temperature

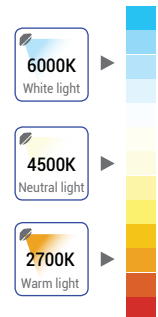



5 PCS  
BLISTER

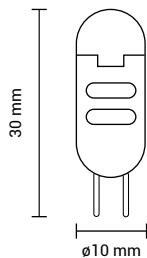

- SKU No.**
- Light Color**
- Watts**
- Input Voltage**
- Flux**
- Beam Angle**
- CRI**
- IP Rating**
- Dimension**

SKU No.	SP1615/SP1616/SP1617
Light Color	6000K/4500K/2800K
Watts	2W
Input Voltage	AC ; DC 12V
Flux	170lm
Beam Angle	320°
CRI	Ra>80
IP Rating	IP20
Dimension	ø10x30 mm

Color Temperature

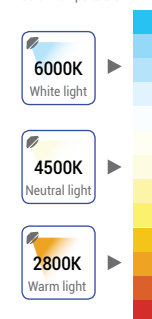

**2W SMD**  
LED Spotlight G4

- 170  
Lumens
- G4
- 320°
- IP20

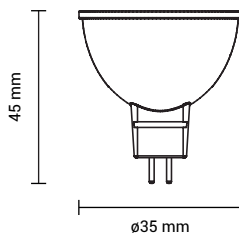

- SKU No.**
- Light Color**
- Watts**
- Input Voltage**
- Flux**
- Beam Angle**
- CRI**
- IP Rating**
- Dimension**

SKU No.	SP1066/SP1067/SP1068
Light Color	6000K/4500K/2700K
Watts	3W
Input Voltage	AC ; DC 12V
Flux	210lm
Beam Angle	38°
CRI	Ra>80
IP Rating	IP20
Dimension	ø35x45 mm

Color Temperature

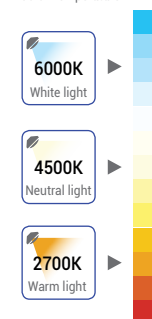

**3W SMD**  
LED Spotlight G4/MR11

- 210  
Lumens
- G4
- 38°
- IP20





5 PCS  
BLISTER

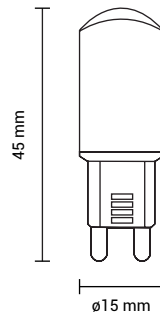

- SKU No.**
- Light Color**
- Watts**
- Input Voltage**
- Flux**
- Beam Angle**
- CRI**
- IP Rating**
- Dimension**

<b>SKU No.</b>	SP1638/SP1639/SP1640
<b>Light Color</b>	6000K/4500K/2800K
<b>Watts</b>	3W
<b>Input Voltage</b>	AC : 170-265V
<b>Flux</b>	220lm
<b>Beam Angle</b>	360°
<b>CRI</b>	Ra>80
<b>IP Rating</b>	IP20
<b>Dimension</b>	ø15x45 mm

Color Temperature

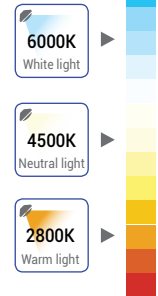

**3W SMD**

LED Spotlight G9



Lumens



5 PCS  
BLISTER

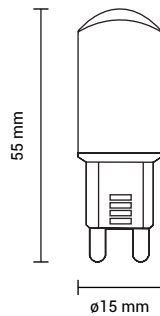

- SKU No.**
- Light Color**
- Watts**
- Input Voltage**
- Flux**
- Beam Angle**
- CRI**
- IP Rating**
- Dimension**

<b>SKU No.</b>	SP1635/SP1636/SP1637
<b>Light Color</b>	6000K/4500K/2800K
<b>Watts</b>	5W
<b>Input Voltage</b>	AC : 170-265V
<b>Flux</b>	380lm
<b>Beam Angle</b>	360°
<b>CRI</b>	Ra>80
<b>IP Rating</b>	IP20
<b>Dimension</b>	ø15x55 mm

Color Temperature

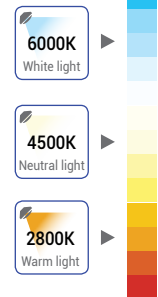

**5W SMD**

LED Spotlight G9



Lumens



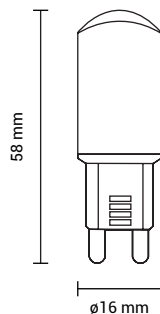

- SKU No.**
- Light Color**
- Watts**
- Input Voltage**
- Flux**
- Beam Angle**
- CRI**
- IP Rating**
- Dimension**

SKU No.	SP1618/SP1619/SP1620
Light Color	6000K/4500K/2800K
Watts	6W
Input Voltage	AC : 175-265V
Flux	500lm
Beam Angle	300°
CRI	Ra>80
IP Rating	IP20
Dimension	16x58 mm

Color Temperature

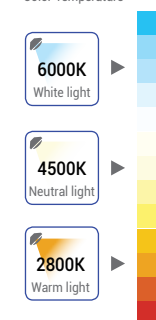

**6W COB**  
LED Spotlight G9

- 500  
Lumens
- G9
- 300°
- IP20

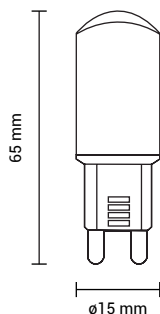

- SKU No.**
- Light Color**
- Watts**
- Input Voltage**
- Flux**
- Beam Angle**
- CRI**
- IP Rating**
- Dimension**

SKU No.	SP1641/SP1642/SP1643
Light Color	6000K/4500K/2800K
Watts	6W
Input Voltage	AC : 170-265V
Flux	600lm
Beam Angle	320°
CRI	Ra>80
IP Rating	IP20
Dimension	15x65 mm

Color Temperature

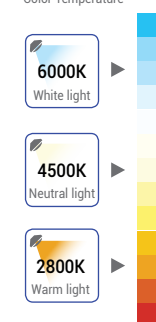

**6W SMD**  
LED Spotlight G9 Dimmable

- 600  
Lumens
- G9
- 320°
- IP20
- DIMMABLE



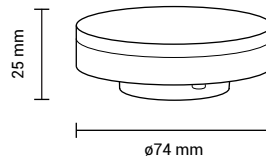

SKU No.	SP1541/SP1542/SP1543
Light Color	6000K/4500K/2800K
Watts	7W
Input Voltage	AC : 220-240V
Flux	560lm
Beam Angle	180°
CRI	Ra>80
IP Rating	IP20
Dimension	ø74x25 mm

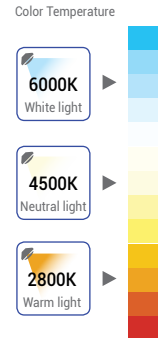

**7W Recessed**  
LED Spotlight GX53

560 Lumens  
 GX53  
 180°  
 IP20

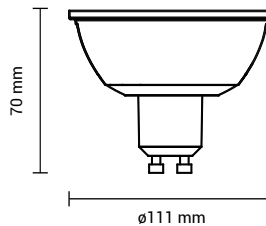

SKU No.	SP1523/SP1524/SP1525
Light Color	6000K/4500K/2800K
Watts	12W
Input Voltage	AC : 170-265V
Flux	960lm
Beam Angle	36°
CRI	Ra>80
IP Rating	IP20
Dimension	ø111x70 mm

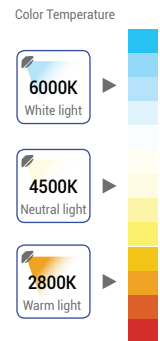

**12W AR111**  
LED Spotlight GU10

960 Lumens  
 GU10  
 36°  
 IP20  
 CERAMIC Body





**9W AR111**  
LED Spotlight GU10

800  
 120°  
 Lumens    120°



**12W AR111**  
LED Spotlight GU10

1200  
 30°  
 Lumens    30°



**12W AR111**  
LED Spotlight GU10

1100  
 30°  
 DIMMABLE  
 Lumens    30°

- SKU No.**
- Light Color**
- Watts**
- Input Voltage**
- Flux**
- Beam Angle**
- CRI**
- IP Rating**
- Dimension**

SKU No.	SP1531/SP1532
Light Color	4500K/2700K
Watts	9W
Input Voltage	AC : 170-265V
Flux	800lm
Beam Angle	120°
CRI	Ra>80
IP Rating	IP20
Dimension	ø111x58 mm

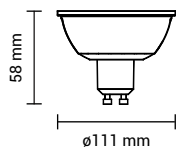

SKU No.	SP1533/SP1534
Light Color	4500K/2700K
Watts	12W
Input Voltage	AC : 170-265V
Flux	1200lm
Beam Angle	30°
CRI	Ra>80
IP Rating	IP20
Dimension	ø111x58 mm

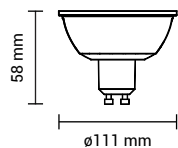

SKU No.	SP1535/SP1536
Light Color	4500K/2700K
Watts	12W
Input Voltage	AC : 170-265V
Flux	1100lm
Beam Angle	30°
CRI	Ra>80
IP Rating	IP20
Dimension	ø111x58 mm

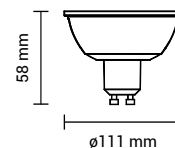

Color Temperature

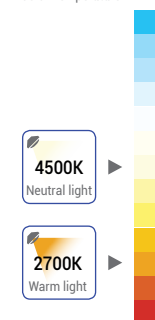

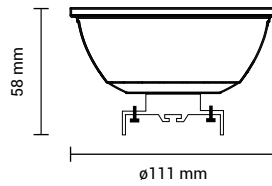

EPISTAR  
Chips

- SKU No.**
- Light Color**
- Watts**
- Input Voltage**
- Flux**
- Beam Angle**
- CRI**
- IP Rating**
- Dimension**

SKU No.	SP1517/SP1516
Light Color	4500K/2700K
Watts	15W
Input Voltage	AC ; DC 12V
Flux	1200lm
Beam Angle	30°
CRI	Ra>80
IP Rating	IP20
Dimension	111x58 mm

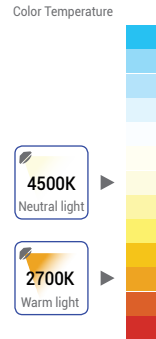

**15W AR111**  
LED Spotlight G5.3

- 1200  
Lumens
- G5.3
- 30°
- IP20

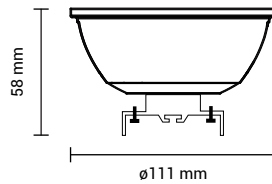

EPISTAR  
Chips

- SKU No.**
- Light Color**
- Watts**
- Input Voltage**
- Flux**
- Beam Angle**
- CRI**
- IP Rating**
- Dimension**

SKU No.	SP1519/SP1518
Light Color	4500K/2700K
Watts	15W
Input Voltage	AC ; DC 12V
Flux	1050lm
Beam Angle	120°
CRI	Ra>80
IP Rating	IP20
Dimension	111x58 mm

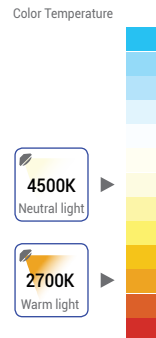

**15W AR111**  
LED Spotlight G5.3

- 1050  
Lumens
- G5.3
- 120°
- IP20



### 5W-7W SMD Premium

LED Spotlight MR16, GU5.3

5  
Years

Warranty



### 5W-7W SMD

LED Spotlight MR16, GU5.3

2  
Years

Warranty



GU5.3



110°



IP20

5W

Lumens

7W

Lumens

5W

Lumens

7W

Lumens

- SKU No.
- Light Color
- Watts
- Input Voltage
- Flux
- Beam Angle
- CRI
- IP Rating
- Dimension

SP1761/SP1762/SP1763	SP1764/SP1765/SP1766	SP1191/SP1192/SP1193	SP1194/SP1195/SP1196
6000K/4500K/2700K	6000K/4500K/2700K	6000K/4500K/2700K	6000K/4500K/2700K
5W	7W	5W	7W
DC 12V	DC 12V	DC 12V	DC 12V
320lm	500lm	400lm	560lm
110°	110°	110°	110°
Ra>80	Ra>80	Ra>80	Ra>80
IP20	IP20	IP20	IP20
ø50x47 mm	ø50x47 mm	ø50x47 mm	ø50x47 mm

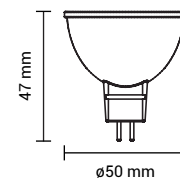
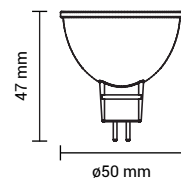
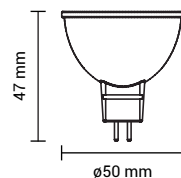
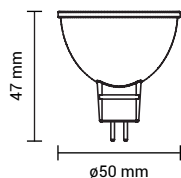

Color Temperature

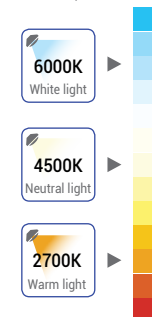

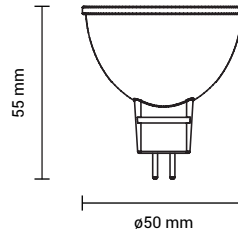

SKU No.	SP1163/SP1167/SP1164
Light Color	6000K/4500K/2700K
Watts	4W
Input Voltage	AC ; DC 12V
Flux	320lm
Beam Angle	50°
CRI	Ra>80
IP Rating	IP20
Dimension	ø50x55 mm

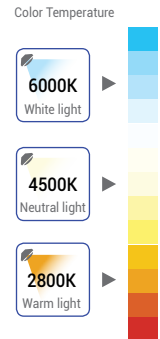

**4W COB**

LED Spotlight MR16, GU5.3

320 Lumens  
 GU5.3  
 50°  
 IP20

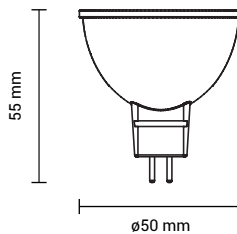

SKU No.	SP1168/SP1169/SP1170
Light Color	6000K/4500K/2700K
Watts	6W
Input Voltage	AC ; DC 12V
Flux	400lm
Beam Angle	50°
CRI	Ra>80
IP Rating	IP20
Dimension	ø50x55 mm

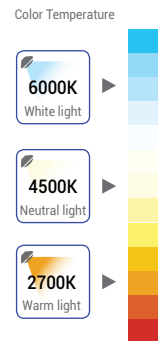

**6W COB**

LED Spotlight MR16, GU5.3

400 Lumens  
 GU5.3  
 50°  
 IP20



**4W-6W COB White**  
LED Spotlight GU10



GU10



50°



IP20

**4W** **320**  
Lumens

**6W** **480**  
Lumens

**6W** **480** **DIMMABLE**  
Lumens

- SKU No.
- Light Color
- Watts
- Input Voltage
- Flux
- Beam Angle
- CRI
- IP Rating
- Dimension

SKU No.	SP1957/SP1958/SP1959
Light Color	6000K/4500K/2700K
Watts	4W
Input Voltage	AC : 220-240V
Flux	320lm
Beam Angle	50°
CRI	Ra>80
IP Rating	IP20
Dimension	ø50x60 mm

SKU No.	SP1960/SP1961/SP1962
Light Color	6000K/4500K/2700K
Watts	6W
Input Voltage	AC : 220-240V
Flux	480lm
Beam Angle	50°
CRI	Ra>80
IP Rating	IP20
Dimension	ø50x60mm

SKU No.	SP1963/SP1964/SP1965
Light Color	6000K/4500K/2700K
Watts	6W
Input Voltage	AC : 220-240V
Flux	480lm
Beam Angle	50°
CRI	Ra>80
IP Rating	IP20
Dimension	ø50x60mm

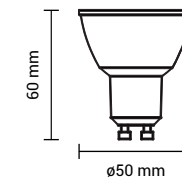
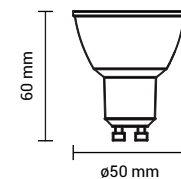
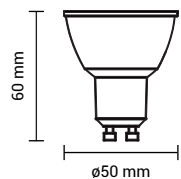

Color Temperature

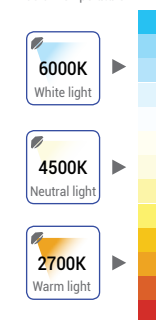



GU10



50°



IP20

**4W-6W COB Gray**  
LED Spotlight GU10

**4W** **320**  
Lumens

**6W** **480**  
Lumens

**4W** **320**   
Lumens DIMMABLE

**6W** **480**   
Lumens DIMMABLE

- SKU No.
- Light Color
- Watts
- Input Voltage
- Flux
- Beam Angle
- CRI
- IP Rating
- Dimension

SP1263/SP1264/SP1265
6000K/4500K/2700K
4W
AC : 220-240V
320lm
50°
Ra>80
IP20
ø50x60 mm

SP1269/SP1271/SP1270
6000K/4500K/2700K
6W
AC : 220-240V
480lm
50°
Ra>80
IP20
ø50x60mm

SP1266/SP1267/SP1268
6000K/4500K/2700K
4W
AC : 220-240V
320lm
50°
Ra>80
IP20
ø50x60 mm

SP1272/SP1273/SP1274
6000K/4500K/2700K
6W
AC : 220-240V
480lm
50°
Ra>80
IP20
ø50x60mm

Color Temperature

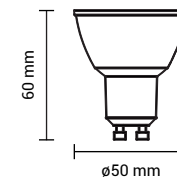
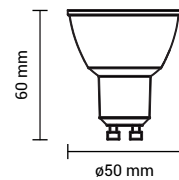
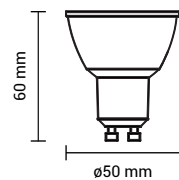
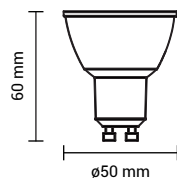
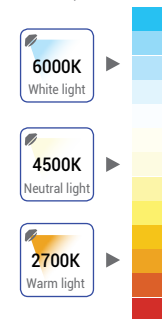



**5W-7W SMD Premium**  
LED Spotlight GU10



GU10



IP20



5 Years  
Warranty

**5W** 320 Lumens 110°

**7W** 500 Lumens 110°

**5W** 320 Lumens 38°

<b>SKU No.</b>	SP1767/SP1768/SP1769
<b>Light Color</b>	6000K/4500K/2700K
<b>Watts</b>	5W
<b>Input Voltage</b>	AC : 175-265V
<b>Flux</b>	320lm
<b>Beam Angle</b>	110°
<b>CRI</b>	Ra>80
<b>IP Rating</b>	IP20
<b>Dimension</b>	ø50x55 mm

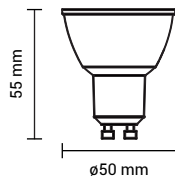

<b>SKU No.</b>	SP1772/SP1770/SP1773
<b>Light Color</b>	6000K/4500K/2700K
<b>Watts</b>	7W
<b>Input Voltage</b>	AC : 175-265V
<b>Flux</b>	500lm
<b>Beam Angle</b>	110°
<b>CRI</b>	Ra>80
<b>IP Rating</b>	IP20
<b>Dimension</b>	ø50x55 mm

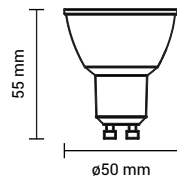

<b>SKU No.</b>	SP1771
<b>Light Color</b>	4500K
<b>Watts</b>	5W
<b>Input Voltage</b>	AC : 175-265V
<b>Flux</b>	320lm
<b>Beam Angle</b>	38°
<b>CRI</b>	Ra>80
<b>IP Rating</b>	IP20
<b>Dimension</b>	ø50x55 mm

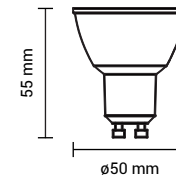

Color Temperature

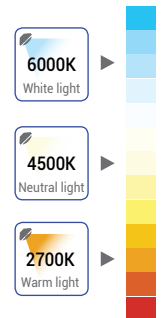



GU10



IP20



5 Years Warranty

## 5W-7W SMD LED Spotlight GU10

**5W** 400 Lumens

**7W** 560 Lumens

**5W** 400 Lumens

**7W** 560 Lumens

**7W** 560 Lumens DIMMABLE

<b>SKU No.</b>	SP1935/SP1936/SP1937
<b>Light Color</b>	6000K/4500K/2700K
<b>Watts</b>	5W
<b>Input Voltage</b>	AC : 175-265V
<b>Flux</b>	400lm
<b>Beam Angle</b>	38°
<b>CRI</b>	Ra>80
<b>IP Rating</b>	IP20
<b>Dimension</b>	ø50x57 mm

<b>SKU No.</b>	SP1938/SP1939/SP1940
<b>Light Color</b>	6000K/4500K/2700K
<b>Watts</b>	7W
<b>Input Voltage</b>	AC : 175-265V
<b>Flux</b>	560lm
<b>Beam Angle</b>	38°
<b>CRI</b>	Ra>80
<b>IP Rating</b>	IP20
<b>Dimension</b>	ø50x57 mm

<b>SKU No.</b>	SP1929/SP1930/SP1931
<b>Light Color</b>	6000K/4500K/2700K
<b>Watts</b>	5W
<b>Input Voltage</b>	AC : 175-265V
<b>Flux</b>	400lm
<b>Beam Angle</b>	110°
<b>CRI</b>	Ra>80
<b>IP Rating</b>	IP20
<b>Dimension</b>	ø50x57 mm

<b>SKU No.</b>	SP1932/SP1933/SP1934
<b>Light Color</b>	6000K/4500K/2700K
<b>Watts</b>	7W
<b>Input Voltage</b>	AC : 175-265V
<b>Flux</b>	560lm
<b>Beam Angle</b>	110°
<b>CRI</b>	Ra>80
<b>IP Rating</b>	IP20
<b>Dimension</b>	ø50x57 mm

<b>SKU No.</b>	SP1945/SP1946/SP1947
<b>Light Color</b>	6000K/4500K/2700K
<b>Watts</b>	7W
<b>Input Voltage</b>	AC : 175-265V
<b>Flux</b>	560lm
<b>Beam Angle</b>	110°
<b>CRI</b>	Ra>80
<b>IP Rating</b>	IP20
<b>Dimension</b>	ø50x57 mm

Color Temperature

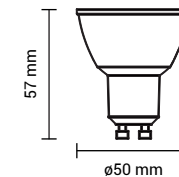
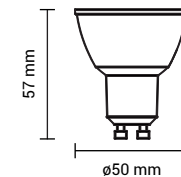
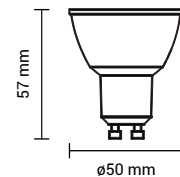
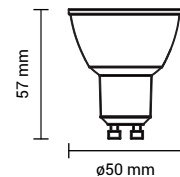
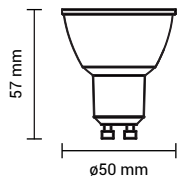
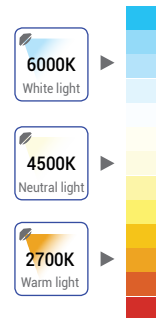



**Accessories**

GU10,MR16 Fitting



72mm

2 PCS  
Box

SKU No.

OT5070 WHITE BODY

OT5071 INOX BODY

OT5072 CHROME BODY

Dimension

ø82x30 mm

ø82x30 mm

ø82x30 mm

**Accessories**

GU10,MR16 Fitting



72mm

2 PCS  
Box

SKU No.

OT5073 WHITE BODY

OT5074 INOX BODY

OT5075 CHROME BODY

Dimension

83x83x30 mm

83x83x30 mm

83x83x30 mm



**Accessories**

GU10,MR16 Fitting Adjustable



SKU No.

OT5170-N WHITE BODY

OT5171-N INOX BODY

OT5172-N CHROME BODY

Dimension

ø83x29 mm

ø83x29 mm

ø83x29 mm

**Accessories**

GU10,MR16 Fitting Adjustable



SKU No.

OT5076 WHITE BODY

OT5077 INOX BODY

OT5078 CHROME BODY

Dimension

83x83x29 mm

83x83x29 mm

83x83x29 mm

**Accessories**

## AR111 Fitting Adjustable



OT5081 WHITE BODY

180x180x42 mm



150x150mm



45°



OT5083 WHITE BODY

330x180x42 mm



300x150mm



45°



OT5085 WHITE BODY

480x180x42 mm



450x150mm



45°

2 PCS  
Box**Accessories**

## AR111 Fitting Adjustable



OT5082 SILVER BODY

180x180x42 mm



150x150mm



45°



OT5084 SILVER BODY

330x180x42 mm



300x150mm



45°



OT5086 SILVER BODY

480x180x42 mm



450x150mm



45°

2 PCS  
Box

**SKU No.**
**Dimension**



**FIRE-RATED FITTING**  
WITH GU10 SOCKET



**FIRE-RATED FITTING**  
WITH GU10 SOCKET  
Adjustable



**FIRE-RATED FITTING**  
WITH GU10 SOCKET  
Waterproof





**SKU No.**

- OT5060 WHITE SHELL
- OT5061 CHROME SHELL
- OT5062 SATIN CHROME SHELL



IP20

 IP Rating IP20

 Dimension ø85x110 mm



GU10

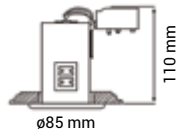

80 mm

**SKU No.**

- OT5063 WHITE SHELL
- OT5064 CHROME SHELL
- OT5065 SATIN CHROME SHELL



45°

 IP Rating IP20

 Dimension ø85x130 mm



GU10

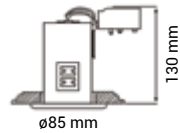

80 mm

**SKU No.**

- OT5066 WHITE SHELL
- OT5067 CHROME SHELL
- OT5068 SATIN CHROME SHELL



IP65

 IP Rating IP65

 Dimension ø85x130 mm



GU10

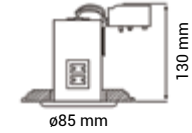

80 mm





**LED TUBES AND BATTEN LIGHTS**

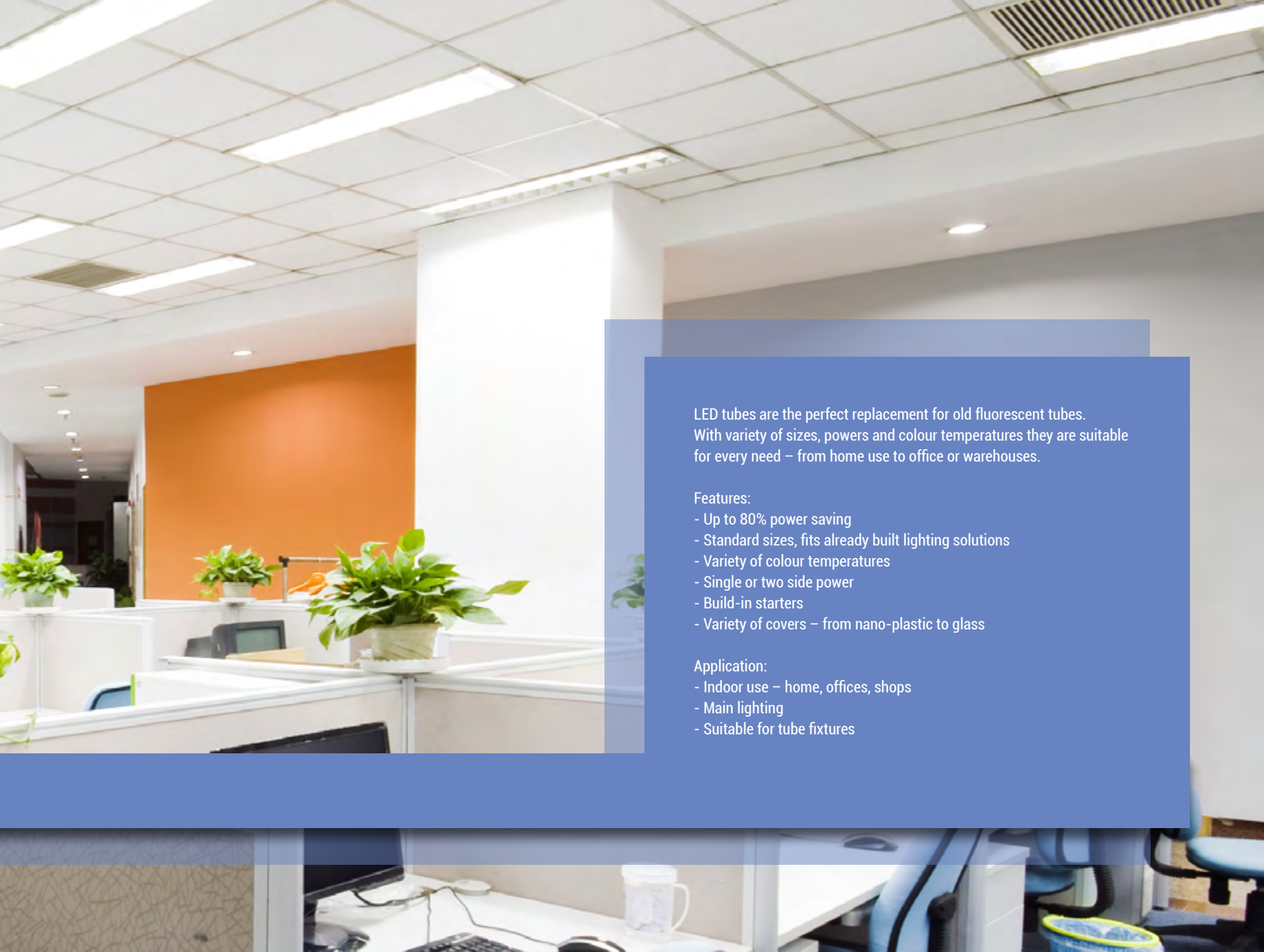

LED tubes are the perfect replacement for old fluorescent tubes. With variety of sizes, powers and colour temperatures they are suitable for every need – from home use to office or warehouses.

Features:

- Up to 80% power saving
- Standard sizes, fits already built lighting solutions
- Variety of colour temperatures
- Single or two side power
- Build-in starters
- Variety of covers – from nano-plastic to glass

Application:

- Indoor use – home, offices, shops
- Main lighting
- Suitable for tube fixtures



Switch



IP20



120°

**LED Tube T5**  
MATT WITH SWITCH

**4W**  
**31cm**

320  
Lumens

**8W**  
**57cm**

640  
Lumens

**12W**  
**87cm**

960  
Lumens

**16W**  
**117cm**

1280  
Lumens

**20W**  
**145cm**

1600  
Lumens

<b>SKU No.</b>	TU5521/TU5522/TU5523	TU5524/TU5525/TU5526	TU5527/TU5528/TU5529	TU5530/TU5531/TU5532	TU5533/TU5534/TU5535
<b>Light Color</b>	6000K/4500K/2800K	6000K/4500K/2800K	6000K/4500K/2800K	6000K/4500K/2800K	6000K/4500K/2800K
<b>Watts</b>	4W	8W	12W	16W	20W
<b>Input Voltage</b>	AC : 220-240V	AC : 220-240V	AC : 220-240V	AC : 220-240V	AC : 220-240V
<b>Flux</b>	320lm	640lm	960lm	1280lm	1600lm
<b>Beam Angle</b>	120°	120°	120°	120°	120°
<b>CRI</b>	Ra>80	Ra>80	Ra>80	Ra>80	Ra>80
<b>IP Rating</b>	IP20	IP20	IP20	IP20	IP20
<b>Dimension</b>	28x310 mm	28x570 mm	28x870 mm	28x1170 mm	28x1450 mm

Color Temperature

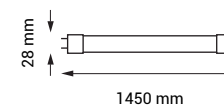
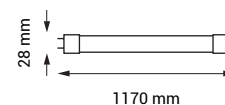
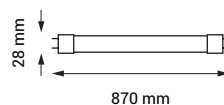
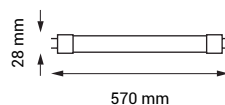
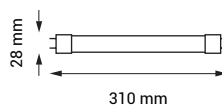
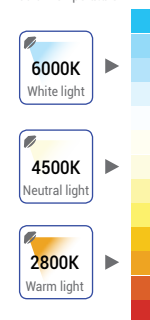



T5 DOUBLE INPUT CABLE



IP20



120°

**LED Tube T5**  
MATT

**SKU No.** AC6625/AC6626/AC6627

**Dimension** 30cm / 50cm / 100cm

**4W**  
**31cm**  
 320  
Lumens

**8W**  
**57cm**  
 640  
Lumens

**12W**  
**87cm**  
 960  
Lumens

**16W**  
**117cm**  
 1280  
Lumens

**20W**  
**145cm**  
 1600  
Lumens

<b>SKU No.</b>	TU5653/TU5645/TU5655	TU5654/TU5646/TU5656	TU5652/TU5647/TU5657	TU5651/TU5648/TU5658	TU5650/TU5649/TU5659
<b>Light Color</b>	6000K/4500K/2800K	6000K/4500K/2800K	6000K/4500K/2800K	6000K/4500K/2800K	6000K/4500K/2800K
<b>Watts</b>	4W	8W	12W	16W	20W
<b>Input Voltage</b>	AC : 220-240V	AC : 220-240V	AC : 220-240V	AC : 220-240V	AC : 220-240V
<b>Flux</b>	320lm	640lm	960lm	1280lm	1600lm
<b>Beam Angle</b>	120°	120°	120°	120°	120°
<b>CRI</b>	Ra>80	Ra>80	Ra>80	Ra>80	Ra>80
<b>IP Rating</b>	IP20	IP20	IP20	IP20	IP20
<b>Dimension</b>	28x310 mm	28x570 mm	28x870 mm	28x1170 mm	28x1450 mm

Color Temperature

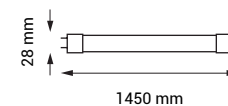
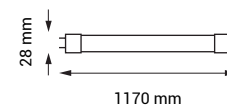
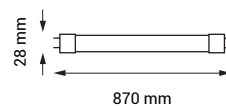
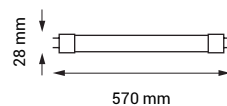
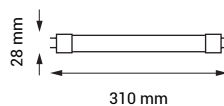
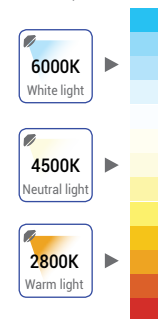



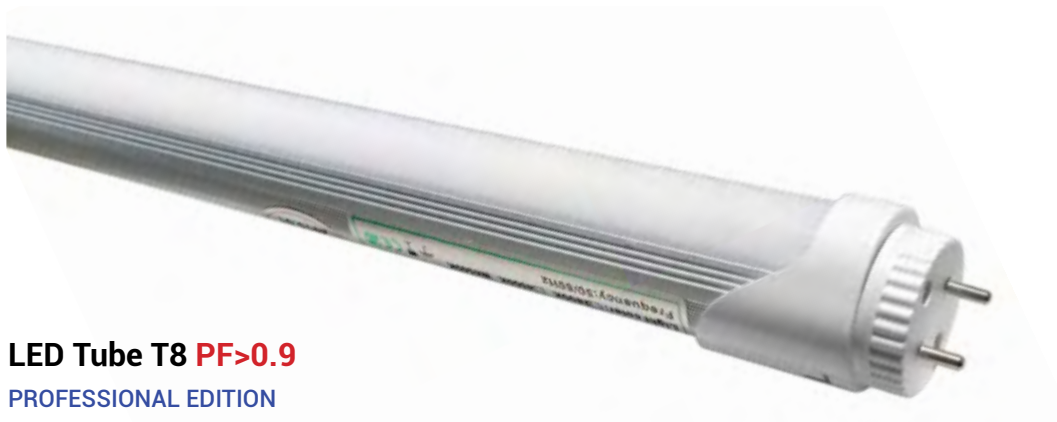

**LED Tube T8 PF>0.9**  
PROFESSIONAL EDITION  
ONE SIDE POWER



With Starter



IP20



200°

**9W**  
**60cm**

810  
Lumens

**18W**  
**120cm**

1610  
Lumens

**22W**  
**150cm**

1980  
Lumens

- SKU No.
- Light Color
- Watts
- Input Voltage
- Flux
- Beam Angle
- CRI
- IP Rating
- Dimension

SKU No.	TU5611-M/TU5613-M/TU5612-M
Light Color	6000K/4500K/2800K
Watts	9W
Input Voltage	AC : 220-240V
Flux	810lm
Beam Angle	200°
CRI	Ra>80
IP Rating	IP20
Dimension	ø28x600 mm

SKU No.	TU5623-M/TU5625-M/TU5624-M
Light Color	6000K/4500K/2800K
Watts	18W
Input Voltage	AC : 220-240V
Flux	1610lm
Beam Angle	200°
CRI	Ra>80
IP Rating	IP20
Dimension	ø28x1200 mm

SKU No.	TU5641-M/TU5642-M/TU5643-M
Light Color	6000K/4500K/2800K
Watts	22W
Input Voltage	AC : 220-240V
Flux	1980lm
Beam Angle	200°
CRI	Ra>80
IP Rating	IP20
Dimension	ø28x1500 mm

Color Temperature

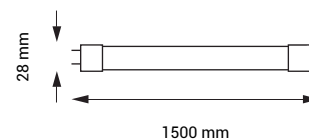
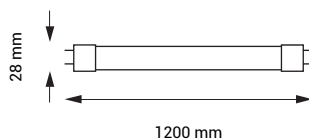
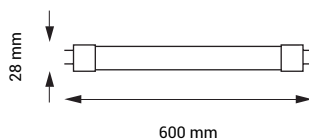
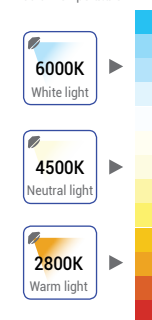



**LED Tube T8 PF>0.95**  
NANO PLASTIC  
ONE SIDE POWER



With Starter



**9W**  
**60cm**  
1050  
Lumens

**18W**  
**120cm**  
2150  
Lumens

**22W**  
**150cm**  
2650  
Lumens

- SKU No.
- Light Color
- Watts
- Input Voltage
- Flux
- Beam Angle
- CRI
- IP Rating
- Dimension

SKU No.	TU5511/TU5512/TU5513
Light Color	6000K/4100K/2800K
Watts	9W
Input Voltage	AC : 175-240V
Flux	1050lm
Beam Angle	270°
CRI	Ra>80
IP Rating	IP20
Dimension	ø28x600 mm

SKU No.	TU5514/TU5515/TU5516
Light Color	6000K/4100K/2800K
Watts	18W
Input Voltage	AC : 175-240V
Flux	2150lm
Beam Angle	270°
CRI	Ra>80
IP Rating	IP20
Dimension	ø28x1200mm

SKU No.	TU5517/TU5518/TU5519
Light Color	6000K/4100K/2800K
Watts	22W
Input Voltage	AC : 175-240V
Flux	2650lm
Beam Angle	270°
CRI	Ra>80
IP Rating	IP20
Dimension	ø28x1500mm

Color Temperature

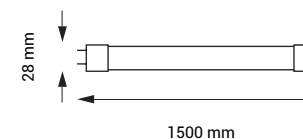
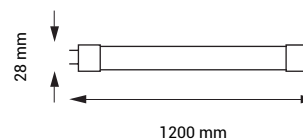
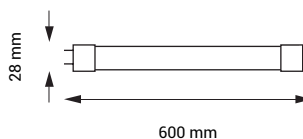
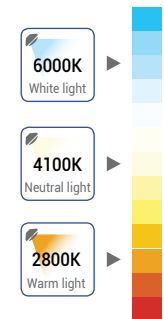



IP20



270°

### LED Tube T8 PF>0.9

CITY LINE - GLASS  
ONE SIDE POWER

**9W**  
**60cm**

800  
Lumens

**18W**  
**120cm**

1600  
Lumens

**22W**  
**150cm**

2000  
Lumens

**24W**  
**150cm**

3000  
HIGH  
Lumens

- SKU No.
- Light Color
- Watts
- Input Voltage
- Flux
- Beam Angle
- CRI
- IP Rating
- Dimension

SKU No.	TU5601/TU5602/TU5603	TU5604/TU5605/TU5606	TU5607/TU5608/TU5609	TU5610/TU5611
Light Color	6000K/4500K/3000K	6000K/4500K/3000K	6000K/4500K/3000K	6000K/4500K
Watts	9W	18W	22W	24W
Input Voltage	AC : 175-265V	AC : 175-265V	AC : 175-265V	AC : 175-265V
Flux	800lm	1600lm	2000lm	3000lm
Beam Angle	270°	270°	270°	270°
CRI	Ra>80	Ra>80	Ra>80	Ra>80
IP Rating	IP20	IP20	IP20	IP20
Dimension	ø28x600 mm	ø28x1200mm	ø28x1500mm	ø28x1500mm

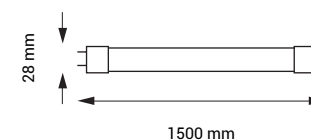
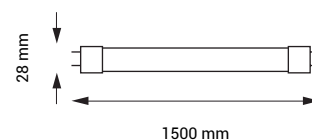
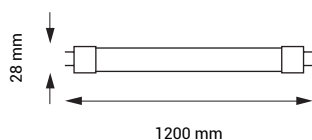
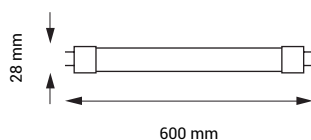

Color Temperature

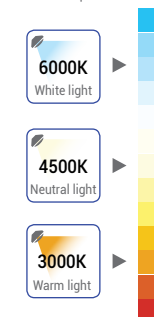

## Single T8 Tube Socket Fixture

FOR ONE-SIDE POWER



IP65



For Single LED Tube 9W - 60cm

 **SKU No.** OT6650

 **Dimension**

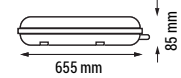

For Single LED Tube 18W - 120cm

 **SKU No.** OT6652

 **Dimension**

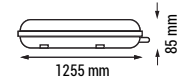

For Single LED Tube 22W - 150cm

 **SKU No.** OT6654

 **Dimension**

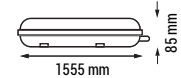

## Double T8 Tube Socket Fixture

FOR ONE-SIDE POWER



IP65



For Two LED Tubes 9W - 60cm

 **SKU No.** OT6651

 **Dimension**

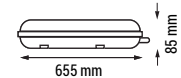

For Two LED Tubes 18W - 120cm

 **SKU No.** OT6653

 **Dimension**

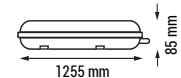

For Two LED Tubes 22W - 150cm









 **SKU No.** OT6655

 **Dimension**





Stainless steel clips

-  **SKU No.**
-  **Light Color**
-  **Watts**
-  **Input Voltage**
-  **Flux**
-  **Beam Angle**
-  **CRI**
-  **IP Rating**
-  **Dimension**

OT6661/OT6662
6000K/4500K
40W
AC : 175-240V
3800lm
180°
Ra>80
IP65
1200x75 mm

Color Temperature

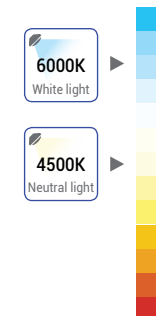

**40W LED**  
IP65 FIXTURE TYPE







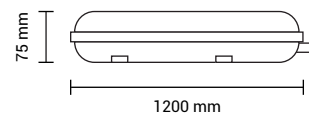

  
3800  
Lumens

  
180°

  
IP65



Stainless steel clips

-  **SKU No.**
-  **Light Color**
-  **Watts**
-  **Input Voltage**
-  **Flux**
-  **Beam Angle**
-  **CRI**
-  **IP Rating**
-  **Dimension**

OT6663/OT6664
6000K/4500K
60W
AC : 175-240V
5700lm
180°
Ra>80
IP65
1500x75 mm

Color Temperature

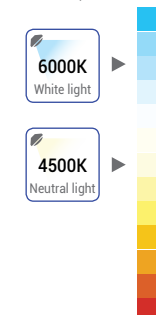

**60W LED**  
IP65 FIXTURE TYPE

  
5700  
Lumens

  
180°

  
IP65

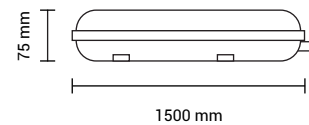



Stainless steel clips

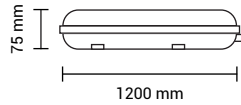

**40W LED**  
IP65 FIXTURE TYPE



3800  
Lumens



180°



IP65

- SKU No.**
- Light Color**
- Watts**
- Input Voltage**
- Flux**
- Beam Angle**
- CRI**
- IP Rating**
- Dimension**

OT6659/OT6665
6000K/4500K
40W
AC : 175-240V
3800lm
180°
Ra>80
IP65
1200x75 mm

OT6660/OT6666
6000K/4500K
40W
AC : 175-240V
3800lm
180°
Ra>80
IP65
1200x75 mm



SENSOR



EMERGENCY



Stainless steel clips

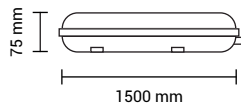

**60W LED**  
IP65 FIXTURE TYPE



5700  
Lumens



180°



IP65

- SKU No.**
- Light Color**
- Watts**
- Input Voltage**
- Flux**
- Beam Angle**
- CRI**
- IP Rating**
- Dimension**

OT6670/OT6667
6000K/4500K
60W
AC : 175-240V
5700lm
180°
Ra>80
IP65
1500x75 mm

OT6669/OT6668
6000K/4500K
60W
AC : 175-240V
5700lm
180°
Ra>80
IP65
1500x75 mm



SENSOR



EMERGENCY



**LED Batten light PF>0.9**

STAINLESS STEEL CLIPS

**10W**  
**30cm**

800  
Lumens

**20W**  
**60cm**

1600  
Lumens

**40W**  
**120cm**

3200  
Lumens

**50W**  
**150cm**

4150  
Lumens

SKU No.	OT6671/OT6672/OT6673	OT6674/OT6675/OT6676	OT6677/OT6678/OT6679	OT6680/OT6681/OT6682
Light Color	6000K/4500K/3000K	6000K/4500K/3000K	6000K/4500K/3000K	6000K/4500K/3000K
Watts	10W	20W	40W	50W
Input Voltage	AC : 220-240V	AC : 220-240V	AC : 220-240V	AC : 220-240V
Flux	800lm	1600lm	3200lm	4150lm
Beam Angle	120°	120°	120°	120°
CRI	Ra>80	Ra>80	Ra>80	Ra>80
IP Rating	IP20	IP20	IP20	IP20
Dimension	300x25x70 mm	600x25x70 mm	1200x25x70 mm	1500x25x70 mm

Color Temperature

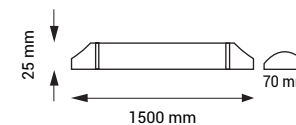
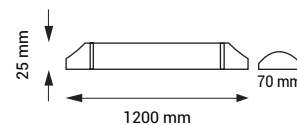
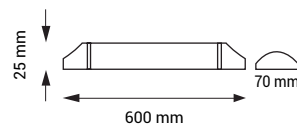
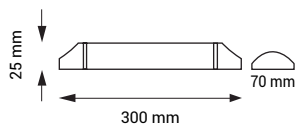
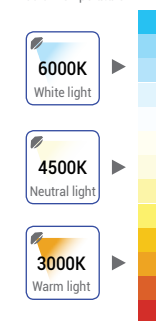





IP65



120°

**LED Batten light PF>0.9**

STAINLESS STEEL CLIPS

Waterproof -IP65

**20W**  
**60cm**  
1600  
Lumens

**40W**  
**120cm**  
3200  
Lumens

**50W**  
**150cm**  
4150  
Lumens

<b>SKU No.</b>	TU6691/TU6692
<b>Light Color</b>	6000K/4500K
<b>Watts</b>	20W
<b>Input Voltage</b>	AC : 220-240V
<b>Flux</b>	1600lm
<b>Beam Angle</b>	120°
<b>CRI</b>	Ra>80
<b>IP Rating</b>	IP65
<b>Dimension</b>	600x25x52 mm

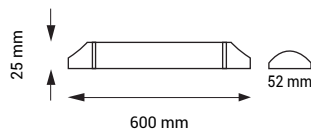

<b>SKU No.</b>	TU6694/TU6695
<b>Light Color</b>	6000K/4500K
<b>Watts</b>	40W
<b>Input Voltage</b>	AC : 220-240V
<b>Flux</b>	3200lm
<b>Beam Angle</b>	120°
<b>CRI</b>	Ra>80
<b>IP Rating</b>	IP65
<b>Dimension</b>	1200x25x52 mm

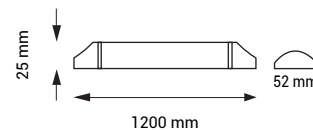

<b>SKU No.</b>	TU6697/TU6698
<b>Light Color</b>	6000K/4500K
<b>Watts</b>	50W
<b>Input Voltage</b>	AC : 220-240V
<b>Flux</b>	4150lm
<b>Beam Angle</b>	120°
<b>CRI</b>	Ra>80
<b>IP Rating</b>	IP65
<b>Dimension</b>	1500x25x52 mm

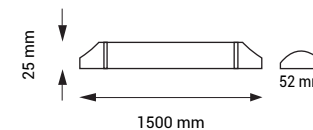

Color Temperature

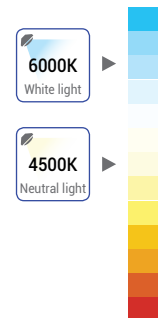







An emergency light is a battery-backed lighting device that switches on automatically when a building experiences a power outage.

All bulkhead and exit sign are included 4 pictogram :







- Left Arrow
- Right Arrow
- UP Arrow
- EXIT





-  **SKU No.** WW7203
-  **Watts** 2W
-  **Voltage** AC: 220-240V
-  **IP Rating** IP20
-  **Light Color** 6000K White Light
-  **Battery** 3.6V 900mAh Ni-Cd battery
-  **Emergency duration** >3 Hours



-  **SKU No.** WW7204
-  **Watts** 2W
-  **Voltage** AC: 220-240V
-  **IP Rating** IP20
-  **Light Color** 6000K White Light
-  **Battery** 3.6V 900mAh Ni-Cd battery
-  **Emergency duration** >3 Hours

### Emergency LED Exit Sign

Wall / Surface Mount







### Emergency LED Exit Sign

Wall / Surface Mount

### Emergency LED Exit Sign

Recessed Fixed









-  **SKU No.** WW7206
-  **Watts** 2W
-  **Voltage** AC: 220-240V
-  **IP Rating** IP20
-  **Light Color** 6000K White Light
-  **Battery** 3.6V 900mAh Ni-Cd battery
-  **Emergency duration** >3 Hours





### Emergency LED Exit Sign

Recessed Hanging



-  **SKU No.** WW7205
-  **Watts** 2W
-  **Voltage** AC: 220-240V
-  **IP Rating** IP20
-  **Light Color** 6000K White Light
-  **Battery** 3.6V 900mAh Ni-Cd battery
-  **Emergency duration** >3 Hours



 SKU No.	WW7201
 Watts	3W
 Voltage	AC: 220-240V
 IP Rating	IP65
 Light Color	6000K White Light
 Battery	3.6V 1500mAh Ni-Cd battery
 Emergency duration	>3 Hours



IP65

### Recessed kit for WW7201



 SKU No. WW7202



## Emergency LED Light

BULKHEAD

## Emergency LED Exit Sign

Wall Mounted



 SKU No.	WW7207
 Watts	3W
 Voltage	AC: 220-240V
 IP Rating	IP20
 Light Color	6000K White Light
 Battery	3.6V 1200mAh Ni-Cd battery
 Emergency duration	>3 Hours



IP20





- SKU No.** WW7208
- Watts** 2x3 pcs 0.5W
- Voltage** AC: 220-240V
- IP Rating** IP20
- Light Color** 6000K White Light
- Battery** 3.6V/1800mAh
- Emergency duration** >3 Hours

**Emergency LED Light 3W**  
Wall Mounted - Self Test



Lumens



- SKU No.** WW7209
- Watts** 2x6 pcs 0.5W
- Voltage** AC: 220-240V
- IP Rating** IP20
- Light Color** 6000K White Light
- Battery** 3.6V/3000mAh
- Emergency duration** >3 Hours

**Emergency LED Light 6W**  
Wall Mounted - Self Test



Lumens

**Emergency LED Light**  
Downlight



IP20



Lumens



- SKU No.** WW7210
- Watts** 3W
- Voltage** AC: 220-240V
- IP Rating** IP20
- Light Color** 6000K White Light
- Battery** 3.6V/1800mAh
- Emergency duration** >3 Hours

**Emergency LED Light**  
Downlight - OSRAM Chip



IP20



Lumens



- SKU No.** WW7211
- Watts** 3W
- Voltage** AC: 220-240V
- IP Rating** IP20
- Light Color** 6000K White Light
- Battery** 3.6V/1800mAh
- Emergency duration** >3 Hours

**OSRAM**  
Chips



EPISTAR  
Chips



IP20















150°



5  
Years  
Warranty

## LED Surface Panel Premium PF>0.9

EMC APPROVED - ROUND

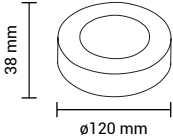
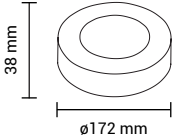
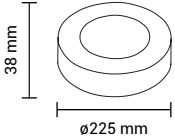
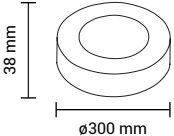
	6W  Lumens	12W  Lumens	18W  Lumens	24W  Lumens
 SKU No.	DL2511/DL2512/DL2513	DL2514/DL2515/DL2516	DL2517/DL2518/DL2519	DL2520/DL2521/DL2522
 Light Color	6000K/4500K/2800K	6000K/4500K/2800K	6000K/4500K/2800K	6000K/4500K/2800K
 Watts	6W	12W	18W	24W
 Input Voltage	AC : 170-265V	AC : 170-265V	AC : 170-265V	AC : 170-265V
 Flux	420lm	960lm	1440lm	1920lm
 Beam Angle	150°	150°	150°	150°
 CRI	Ra>80	Ra>80	Ra>80	Ra>80
 IP Rating	IP20	IP20	IP20	IP20
 Dimension	ø120x38 mm	ø172x38 mm	ø225x38 mm	ø300x38 mm
				

Color Temperature

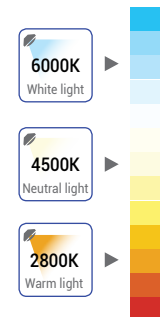



EPISTAR  
Chips



IP20





150°











5  
Years  
Warranty

## LED Surface Panel Premium **PF>0.9**

EMC APPROVED - SQUARE

	6W  420 Lumens	12W  960 Lumens	18W  1440 Lumens	24W  1920 Lumens
--	--	---	--	--

	6W	12W	18W	24W
 <b>SKU No.</b>	DL2523/DL2524/DL2525	DL2526/DL2527/DL2528	DL2529/DL2530/DL2531	DL2532/DL2533/DL2534
 <b>Light Color</b>	6000K/4500K/2800K	6000K/4500K/2800K	6000K/4500K/2800K	6000K/4500K/2800K
 <b>Watts</b>	6W	12W	18W	24W
 <b>Input Voltage</b>	AC : 170-265V	AC : 170-265V	AC : 170-265V	AC : 170-265V
 <b>Flux</b>	420lm	960lm	1440lm	1920lm
 <b>Beam Angle</b>	150°	150°	150°	150°
 <b>CRI</b>	Ra>80	Ra>80	Ra>80	Ra>80
 <b>IP Rating</b>	IP20	IP20	IP20	IP20
 <b>Dimension</b>	120x120x35 mm	167x167x35 mm	220x220x35 mm	295x295x35 mm

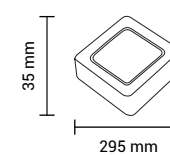
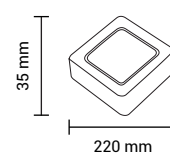
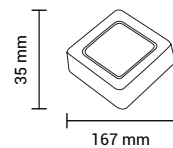
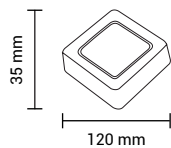

Color Temperature

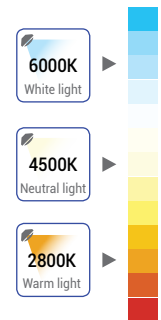

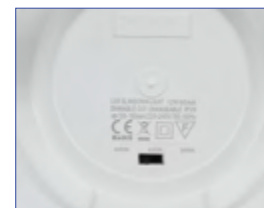

Color changing knob



IP44



100°



3  
Years  
Warranty

### CCT-Surface LED Panel

COLOR CHANGING LED 3000-4500-6000K  
ROUND

**6W**



Lumens

**12W**



Lumens

**18W**











Lumens

**24W**



Lumens

-  SKU No.
-  Light Color
-  Watts
-  Input Voltage
-  Flux
-  Beam Angle
-  CRI
-  IP Rating
-  Dimension

DL2535	DL2536	DL2537	DL2538
3000K-4500K-6000K	3000K-4500K-6000K	3000K-4500K-6000K	3000K-4500K-6000K
6W	12W	18W	24W
AC : 165-265V	AC : 165-265V	AC : 165-265V	AC : 165-265V
480lm	960lm	1440lm	1920lm
100°	100°	100°	100°
Ra>80	Ra>80	Ra>80	Ra>80
IP44 Front	IP44 Front	IP44 Front	IP44 Front
ø115x32 mm	ø170x32 mm	ø220x32 mm	ø240x32 mm

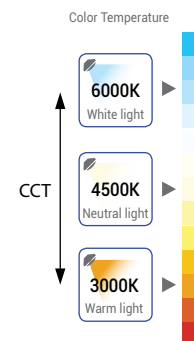
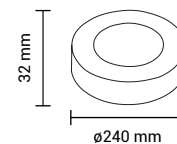
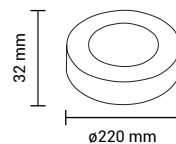
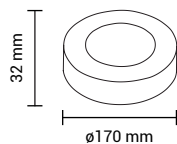
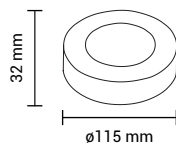





Color changing knob



IP44



100°











3  
Years  
Warranty

## CCT-Surface LED Panel

COLOR CHANGING LED 3000-4500-6000K  
SQUARE

	6W  480 Lumens	12W  960 Lumens	18W  1440 Lumens	24W  1920 Lumens
--	--	---	--	--

	DL2539	DL2540	DL2541	DL2542
 SKU No.	DL2539	DL2540	DL2541	DL2542
 Light Color	3000K-4500K-6000K	3000K-4500K-6000K	3000K-4500K-6000K	3000K-4500K-6000K
 Watts	6W	12W	18W	24W
 Input Voltage	AC : 170-265V	AC : 170-265V	AC : 170-265V	AC : 170-265V
 Flux	480lm	960lm	1440lm	1920lm
 Beam Angle	100°	100°	100°	100°
 CRI	Ra>80	Ra>80	Ra>80	Ra>80
 IP Rating	IP44 Front	IP44 Front	IP44 Front	IP44 Front
 Dimension	122x122x35 mm	172x172x35 mm	227x227x35 mm	227x227x35 mm

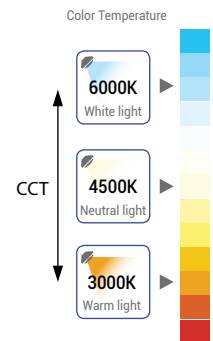
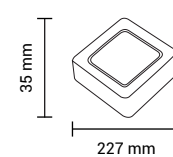
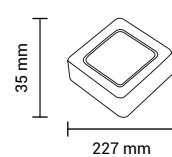
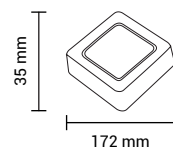
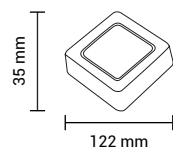



Built-in Driver



IP20



120°









## LED Surface Panel City Line

### BUILT-IN DRIVER - ROUND

**6W**   
375  
Lumens

**12W**   
940  
Lumens

**18W**   
1500  
Lumens

-  **SKU No.**
-  **Light Color**
-  **Watts**
-  **Input Voltage**
-  **Flux**
-  **Beam Angle**
-  **CRI**
-  **IP Rating**
-  **Dimension**

DL2645/DL2646/DL2647
6000K/4500K/2700K
6W
AC : 95-265V
375lm
120°
Ra>80
IP20
ø150x35 mm

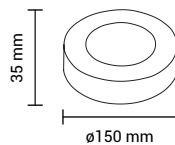

DL2648/DL2649/DL2650
6000K/4500K/2700K
12W
AC : 95-265V
940lm
120°
Ra>80
IP20
ø200x35 mm

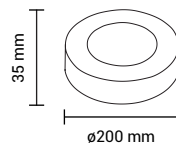

DL2651/DL2652/DL2653
6000K/4500K/2700K
18W
AC : 95-265V
1500lm
120°
Ra>80
IP20
ø250x35 mm

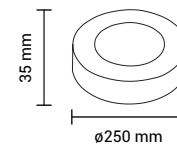

Color Temperature

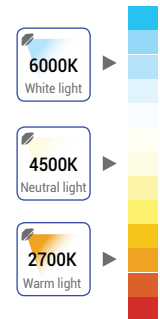

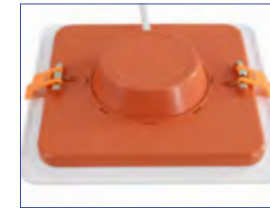

Built-in Driver



IP20



120°

## LED Surface Panel City Line

BUILT-IN DRIVER - SQUARE

**6W**



Lumens

**12W**











Lumens

**18W**



Lumens

-  **SKU No.**
-  **Light Color**
-  **Watts**
-  **Input Voltage**
-  **Flux**
-  **Beam Angle**
-  **CRI**
-  **IP Rating**
-  **Dimension**

DL2657/DL2658/DL2659
6000K/4500K/2700K
6W
AC : 95-265V
375lm
120°
Ra>80
IP20
150x150x35 mm

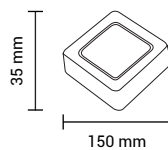

DL2660/DL2661/DL2662
6000K/4500K/2700K
12W
AC : 170-265V
940lm
120°
Ra>80
IP20
200x200x35 mm

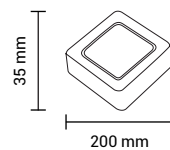

DL2663/DL2664/DL2665
6000K/4500K/2700K
18W
AC : 170-265V
1500lm
120°
Ra>80
IP20
250x250x35 mm

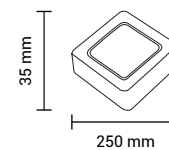

Color Temperature

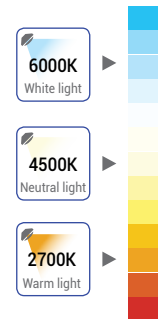



**LED Surface Panel**  
ROUND

<b>6W</b>		<b>12W</b>		<b>18W</b>		<b>24W</b>	
	Lumens		Lumens		Lumens		Lumens

<b>SKU No.</b>	DL2231/DL2243/DL2232	DL2244/DL2245/DL2246	DL2235/DL2247/DL2236	DL2248/DL2249/DL2250
<b>Light Color</b>	6000K/4500K/2800K	6000K/4500K/2800K	6000K/4500K/2800K	6000K/4500K/2800K
<b>Watts</b>	6W	12W	18W	24W
<b>Input Voltage</b>	AC : 220-240V	AC : 220-240V	AC : 220-240V	AC : 220-240V
<b>Flux</b>	480lm	960lm	1440lm	1920lm
<b>Beam Angle</b>	150°	150°	150°	150°
<b>CRI</b>	Ra>80	Ra>80	Ra>80	Ra>80
<b>IP Rating</b>	IP20	IP20	IP20	IP20
<b>Dimension</b>	ø120x38 mm	ø172x38 mm	ø225x38 mm	ø300x38 mm

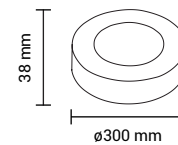
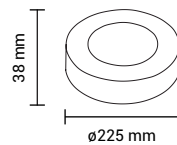
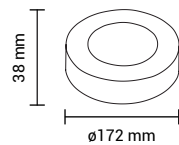
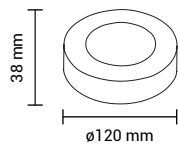
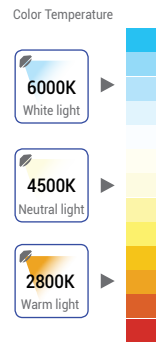

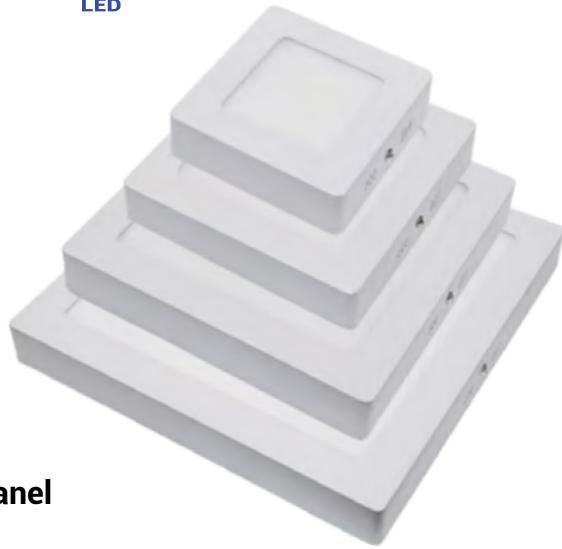













IP20



150°

**LED Surface Panel**  
SQUARE

	6W  480 Lumens	12W  960 Lumens	18W  1440 Lumens	24W  1920 Lumens
--	--	---	--	--

 <b>SKU No.</b>	DL2237/DL2251/DL2238	DL2252/DL2253/DL2254	DL2241/DL2255/DL2242	DL2256/DL2257/DL2258
 <b>Light Color</b>	6000K/4500K/2800K	6000K/4500K/2800K	6000K/4500K/2800K	6000K/4500K/2800K
 <b>Watts</b>	6W	12W	18W	24W
 <b>Input Voltage</b>	AC : 220-240V	AC : 220-240V	AC : 220-240V	AC : 220-240V
 <b>Flux</b>	480lm	960lm	1440lm	1920lm
 <b>Beam Angle</b>	150°	150°	150°	150°
 <b>CRI</b>	Ra>80	Ra>80	Ra>80	Ra>80
 <b>IP Rating</b>	IP20	IP20	IP20	IP20
 <b>Dimension</b>	120x120x38 mm	167x167x38 mm	220x220x38 mm	295x295x38 mm

Color Temperature

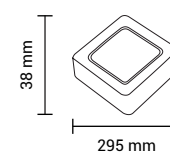
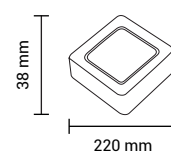
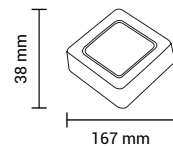
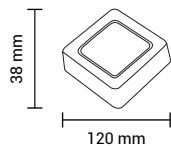
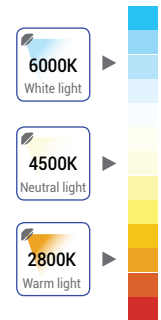



Built-in Driver



IP65



120°

## LED Surface Panel

Thermoplastic - Waterproof

**8W**



Lumens

**12W**











Lumens

**24W**



Lumens

-  SKU No.
-  Light Color
-  Watts
-  Input Voltage
-  Flux
-  Beam Angle
-  CRI
-  IP Rating
-  Dimension

SKU No.	DL2280/DL2281/DL2282
Light Color	6000K/4500K/2800K
Watts	8W
Input Voltage	AC : 180-265V
Flux	640lm
Beam Angle	120°
CRI	Ra>80
IP Rating	IP64
Dimension	ø160x48 mm

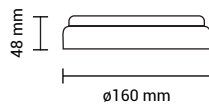

SKU No.	DL2283/DL2284/DL2285
Light Color	6000K/4500K/2800K
Watts	12W
Input Voltage	AC :180-265V
Flux	900lm
Beam Angle	120°
CRI	Ra>80
IP Rating	IP64
Dimension	ø160x48 mm

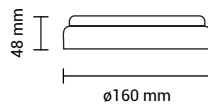

SKU No.	DL2286/DL2287/DL2288
Light Color	6000K/4500K/2800K
Watts	24W
Input Voltage	AC : 180-265V
Flux	1800lm
Beam Angle	120°
CRI	Ra>80
IP Rating	IP64
Dimension	ø240x50 mm

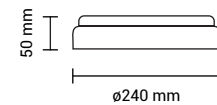

Color Temperature

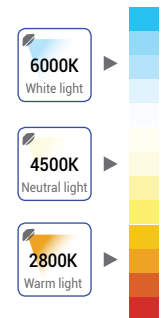



SKU No.	DL2270/DL2271/DL2272
Light Color	6000K/4500K/2800K
Watts	15W
Input Voltage	AC : 180-265V
Flux	1200lm
Beam Angle	120°
CRI	Ra>80
IP Rating	IP20
Dimension	ø248x45 mm

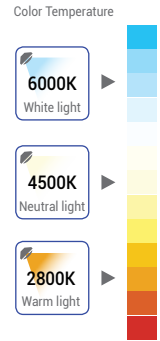

**LED SURFACE PANELS 15W**

Thermoplastic

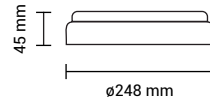

SKU No.	DL2273/DL2274/DL2275
Light Color	6000K/4500K/2800K
Watts	24W
Input Voltage	AC : 180-265V
Flux	2250lm
Beam Angle	120°
CRI	Ra>80
IP Rating	IP20
Dimension	ø310x56 mm

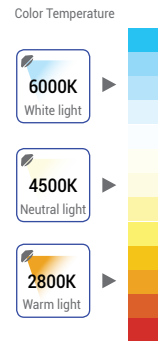

**LED SURFACE PANELS 24W**

Thermoplastic

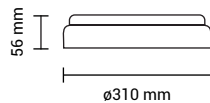



Lumens



120°



IP65



SKU No.



Light Color



Watts



Input Voltage



Flux



Beam Angle



CRI



IP Rating



Dimension

DL2807/DL2808

4500K/2700K

8W

AC : 220-240V

640lm

120°

Ra>80

IP65

ø270x102 mm

DL2809/DL2810

4500K/2700K

8W

AC : 220-240V

640lm

120°

Ra>80

IP65

ø270x102 mm

DL2811/DL2812

4500K/2700K

8W

AC : 220-240V

640lm

120°

Ra>80

IP65

ø270x102 mm

Color Temperature

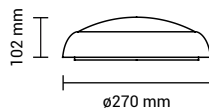
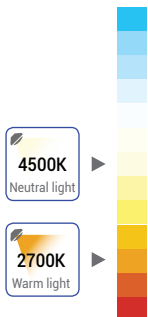

MOTION

MW SENSOR



EMERGENCY KIT

**LED SURFACE CEILING 8W**

Bulkhead - Thermoplastic



Lumens



120°



IP65



SKU No.



Light Color



Watts



Input Voltage



Flux



Beam Angle



CRI



IP Rating



Dimension

DL2813/DL2814

4500K/2700K

13W

AC : 220-240V

1050lm

120°

Ra>80

IP65

ø320x113 mm

DL2815/DL2816

4500K/2700K

13W

AC : 220-240V

1050lm

120°

Ra>80

IP65

ø320x113 mm

DL2817/DL2818

4500K/2700K

13W

AC : 220-240V

1050lm

120°

Ra>80

IP65

ø320x113 mm

Color Temperature

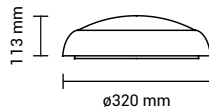
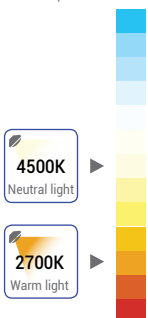

MOTION

MW SENSOR



EMERGENCY KIT

**LED SURFACE CEILING 13W**

Bulkhead - Thermoplastic







**LED SURFACE CEILING 8W**

Bulkhead - Thermoplastic

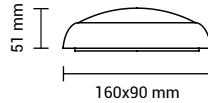

SKU No.	DL2801/DL2802/DL2803
Light Color	6000K/4500K/2700K
Watts	8W
Input Voltage	AC : 220-240V
Flux	600lm
Beam Angle	120°
CRI	Ra>80
IP Rating	IP54
Dimension	160x90x51 mm

600 Lumens
 120°
 IP54

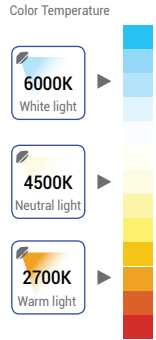

**LED SURFACE CEILING 18W**

Thermoplastic - PIR

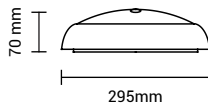

SKU No.	DL2804/DL2805/DL2806
Light Color	6000K/4500K/2700K
Watts	18W
Input Voltage	AC : 220-240V
Flux	1260lm
Beam Angle	120°
CRI	Ra>80
IP Rating	IP20
Dimension	∅295x70 mm

1260 Lumens
 120°
 IP20

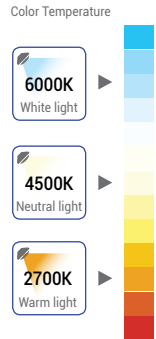



**LED COB SURFACE 12W**  
Round Downlight

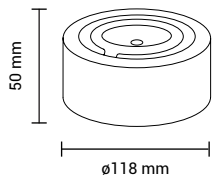

SKU No.	DL2261/DL2265/DL2262
Light Color	600K/4500K/2800K
Watts	12W
Input Voltage	AC : 200-240V
Flux	960lm
Beam Angle	45°
CRI	Ra>80
IP Rating	IP20
Dimension	φ118x50 mm

Color Temperature

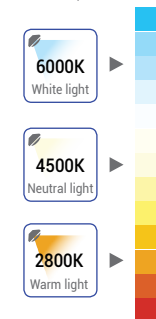

960  
Lumens



45°



IP20



**LED COB SURFACE 12W**  
Square Downlight

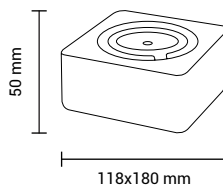

SKU No.	DL2263/DL2266/DL2264
Light Color	6000K/4500K/2800K
Watts	12W
Input Voltage	AC : 175-240V
Flux	960lm
Beam Angle	45°
CRI	Ra>80
IP Rating	IP20
Dimension	118x118x50 mm

Color Temperature

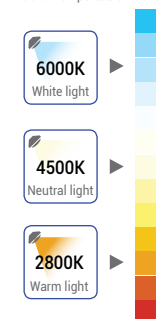

960  
Lumens



45°



IP20





Remote Control included



Warranty

EPISTAR  
Chips



SKU No.



Light Color



Watts



Input Voltage



Flux



Beam Angle



CRI



IP Rating



Dimension

DL2279

3000K to 6000K

40W

AC : 175-240V

2800lm

120°

Ra>80

IP20

ø460x80 mm

Color Temperature

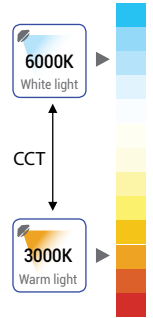

**LED Ceiling Light 40W PF>0.95**

Matt White+Dotty Sparkle



Lumens



DIMMABLE



IP20



Color changing LED 3000 to 6000K



Remote Control included



Warranty

EPISTAR  
Chips



SKU No.



Light Color



Watts



Input Voltage



Flux



Beam Angle



CRI



IP Rating



Dimension

DL2289

3000K to 6000K

40W

AC : 175-240V

2800lm

120°

Ra>80

IP20

ø460x80 mm

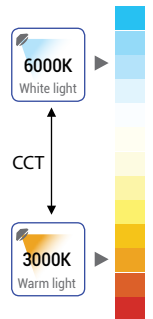

**LED Ceiling Light 40W PF>0.95**

Matt White



Lumens



DIMMABLE



IP20





3 Years

Warranty

EPISTAR Chips

- SKU No.**
- Light Color**
- Watts**
- Input Voltage**
- Flux**
- Beam Angle**
- CRI**
- IP Rating**
- Dimension**

DL2290
3000K to 6000K
40W
AC : 175-240V
2800lm
120°
Ra>80
IP20
ø460x80 mm

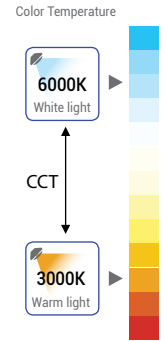

**LED Ceiling Light 40W PF>0.95**  
 Matt White+Dotty Sparkle

2800

Lumens



DIMMABLE



IP20



3 Years

Warranty

EPISTAR Chips

- SKU No.**
- Light Color**
- Watts**
- Input Voltage**
- Flux**
- Beam Angle**
- CRI**
- IP Rating**
- Dimension**

DL2291
3000K to 6000K
40W
AC : 175-240V
2800lm
120°
Ra>80
IP20
ø460x80 mm

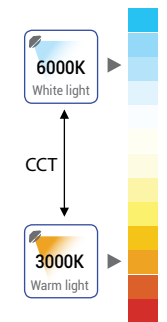

**LED Ceiling Light 40W PF>0.95**  
 Matt White

2800

Lumens



DIMMABLE



IP20





Remote Control included



Warranty

EPISTAR  
Chips



SKU No.



Light Color



Watts



Input Voltage



Flux



Beam Angle



CRI



IP Rating



Dimension

DL2292

3000K to 6000K

60W

AC : 175-240V

3900lm

120°

Ra>80

IP20

ø570x85 mm

Color Temperature

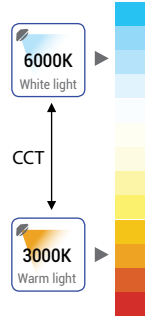

**LED Ceiling Light 60W PF>0.95**

Matt White+Dotty Sparkle



Lumens



DIMMABLE



IP20



Color changing LED 3000 to 6000K



Remote Control included



Warranty

EPISTAR  
Chips



SKU No.



Light Color



Watts



Input Voltage



Flux



Beam Angle



CRI



IP Rating



Dimension

DL2293

3000K to 6000K

60W

AC : 175-240V

3900lm

120°

Ra>80

IP20

ø570x85 mm

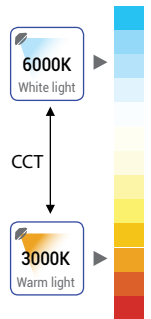

**LED Ceiling Light 60W PF>0.95**

Matt White



Lumens



DIMMABLE



IP20



Color changing LED 3000 to 6000K

3  
Years  
WarrantyEPISTAR  
Chips

SKU No.

DL2294



Light Color

3000K



Watts

42W



Input Voltage

AC : 175-240V



Flux

2100lm



Beam Angle

120°



CRI

Ra&gt;80



IP Rating

IP20



Dimension

ø600x130 mm

Color Temperature

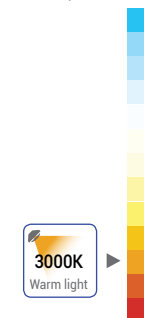

## LED Ceiling Light 42W PF>0.95

Sandy White - Round

2100  
Lumens

120°



IP20

3  
Years  
WarrantyEPISTAR  
Chips

SKU No.

DL2295



Light Color

3000K



Watts

80W



Input Voltage

AC : 175-240V



Flux

4000lm



Beam Angle

120°



CRI

Ra&gt;80



IP Rating

IP20



Dimension

ø800x130 mm

Color Temperature

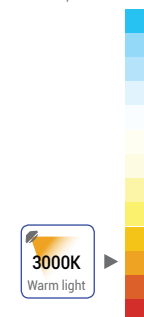

## LED Ceiling Light 80W PF>0.95

Sandy White - Round

4000  
Lumens

120°



IP20





3  
Years

Warranty

EPISTAR  
Chips

SKU No.

Light Color

Watts

Input Voltage

Flux

Beam Angle

CRI

IP Rating

Dimension

DL2298

3000K

26W

AC : 175-240V

1640lm

120°

Ra>80

IP20

ø400x110 mm

Color Temperature

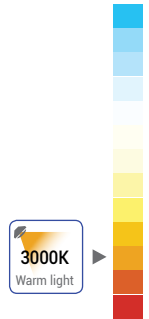

**LED Ceiling Light 26W PF>0.95**

Sandy White - Round

1640  
Lumens

120°

IP20



3  
Years

Warranty

EPISTAR  
Chips

SKU No.

Light Color

Watts

Input Voltage

Flux

Beam Angle

CRI

IP Rating

Dimension

DL2299

3000K

145W

AC : 175-240V

9425lm

120°

Ra>80

IP20

ø1000x110 mm

Color Temperature

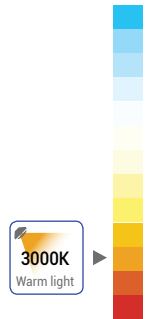

**LED Ceiling Light 145W PF>0.95**

Sandy White - Round

9425  
Lumens

120°

IP20



IP20



120°



3 Years Warranty

EPISTAR Chips



**LED Suspending Light PF>0.95**

Sandy White - Round

**LED Suspending Light PF>0.95**









Sandy White - Square

**38W**   
Lumens

**50W**   
Lumens

**38W**   
Lumens

**50W**   
Lumens

 <b>SKU No.</b>	PD9036	PD9037	PD9038	PD9039
 <b>Light Color</b>	3000K	3000K	3000K	3000K
 <b>Watts</b>	38W	50W	38W	50W
 <b>Input Voltage</b>	AC : 175-240V	AC : 175-240V	AC : 175-240V	AC : 175-240V
 <b>Flux</b>	1900lm	3250lm	1900lm	3250lm
 <b>Beam Angle</b>	120°	120°	120°	120°
 <b>CRI</b>	Ra>80	Ra>80	Ra>80	Ra>80
 <b>IP Rating</b>	IP20	IP20	IP20	IP20
 <b>Dimension</b>	ø450x1200 mm	ø600x1200 mm	450x450x1200 mm	600x600x1200 mm

Color Temperature







<b>SKU No.</b>	DP9035
<b>Light Color</b>	6000K/4500K
<b>Watts</b>	38W
<b>Input Voltage</b>	AC : 175-240V
<b>Flux</b>	1900lm
<b>Beam Angle</b>	120°
<b>CRI</b>	Ra>80
<b>IP Rating</b>	IP20
<b>Dimension</b>	450x450x1200 mm

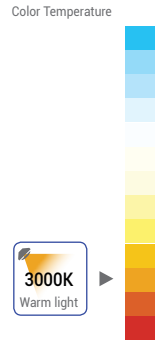

**LED Suspending Light 38W PF>0.95**  
Sandy Black - Square

EPISTAR Chips

3 Years  
Warranty

1900  
Lumens

120°

IP20



<b>SKU No.</b>	DL2297
<b>Light Color</b>	3000K
<b>Watts</b>	38W
<b>Input Voltage</b>	AC : 175-240V
<b>Flux</b>	1900lm
<b>Beam Angle</b>	120°
<b>CRI</b>	Ra>80
<b>IP Rating</b>	IP20
<b>Dimension</b>	450x450x100 mm

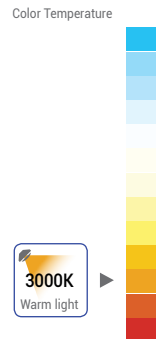

**LED Suspending Light 38W PF>0.95**  
Sandy White - Square

EPISTAR Chips

3 Years  
Warranty

1900  
Lumens

120°

IP20





3 Years

Warranty

EPISTAR Chips

SKU No.

Light Color

Watts

Input Voltage

Flux

Beam Angle

CRI

IP Rating

Dimension

PD9031

3000K

42W

AC : 175-240V

2100lm

120°

Ra>80

IP20

ø600x1200 mm

Color Temperature

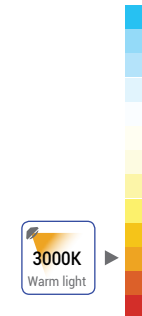

**LED Suspending Light 42W PF>0.95**  
Sandy White

2100

Lumens

120°

120°

IP20

IP20



3 Years

Warranty

EPISTAR Chips

SKU No.

Light Color

Watts

Input Voltage

Flux

Beam Angle

CRI

IP Rating

Dimension

PD9032

3000K

80W

AC : 175-240V

4000lm

120°

Ra>80

IP20

ø800x1200 mm

Color Temperature

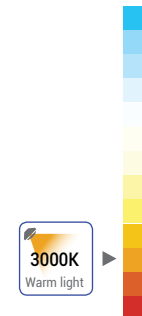

**LED Ceiling Light 80W PF>0.95**  
Sandy White - Round

4000

Lumens

120°

120°

IP20

IP20





**LED Suspending Light 26W PF>0.95**

Sandy White



Warranty



SKU No.

PD9033



Light Color

3000K



Watts

26W



Input Voltage

AC : 175-240V



Flux

1640lm



Beam Angle

120°



CRI

Ra>80



IP Rating

IP20



Dimension

ø400x1200 mm

Color Temperature

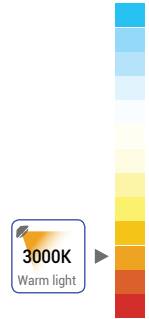

Lumens



120°



IP20



**LED Ceiling Light 145W PF>0.95**

Sandy White - Round



Warranty



SKU No.

PD9034



Light Color

3000K



Watts

145W



Input Voltage

AC : 175-240V



Flux

9425lm



Beam Angle

120°



CRI

Ra>80



IP Rating

IP20



Dimension

ø1000x1200 mm

Color Temperature

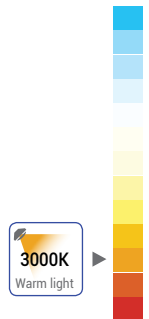

Lumens



120°







IP20



**3D Glass Pendant D300**

## Chrome Fireworks





-  **SKU No.** PD9000
-  **E27 Holder** Max 40W
-  **Material** 3D Glass
-  **Dimension** ø300x275 mm



E27 Holder

**3D Glass Pendant D300**

## Copper Fireworks





-  **SKU No.** PD9001
-  **E27 Holder** Max 40W
-  **Material** 3D Glass
-  **Dimension** ø300x275 mm



E27 Holder

**3D Glass Pendant D250**

## Copper Circles





-  **SKU No.** PD9002
-  **E27 Holder** Max 40W
-  **Material** 3D Glass
-  **Dimension** ø250x220 mm



E27 Holder

**3D Glass Pendant D250**

## Chrome Circles





-  **SKU No.** PD9003
-  **E27 Holder** Max 40W
-  **Material** 3D Glass
-  **Dimension** ø250x220 mm



E27 Holder

### 3D Glass Pendant D200

#### Chrome Squares





-  **SKU No.** PD9004
-  **E27 Holder** Max 40W
-  **Material** 3D Glass
-  **Dimension** ø200x175 mm



E27 Holder

### 3D Glass Pendant D200

#### Copper Squares





-  **SKU No.** PD9005
-  **E27 Holder** Max 40W
-  **Material** 3D Glass
-  **Dimension** ø200x175 mm



E27 Holder

### 3D Glass Pendant D180

#### Chrome Fireworks





-  **SKU No.** PD9006
-  **E27 Holder** Max 40W
-  **Material** 3D Glass
-  **Dimension** ø180x160 mm



E27 Holder

### 3D Glass Pendant D180

#### Copper Fireworks





-  **SKU No.** PD9007
-  **E27 Holder** Max 40W
-  **Material** 3D Glass
-  **Dimension** ø180x160 mm



E27 Holder

**3D Glass Pendant D220**

## Chrome Circles





-  **SKU No.** PD9008
-  **E27 Holder** Max 40W
-  **Material** 3D Glass
-  **Dimension** ø220x275 mm



E27 Holder

**3D Glass Pendant D220**

## Copper Seagull





-  **SKU No.** PD9009
-  **E27 Holder** Max 40W
-  **Material** 3D Glass
-  **Dimension** ø220x275 mm



E27 Holder

**3D Glass Pendant D220**

## Copper Fireworks





-  **SKU No.** PD9010
-  **E27 Holder** Max 40W
-  **Material** 3D Glass
-  **Dimension** ø220x275 mm



E27 Holder

**3D Glass Pendant D220**

## Chrome Seagull





-  **SKU No.** PD9011
-  **E27 Holder** Max 40W
-  **Material** 3D Glass
-  **Dimension** ø220x275 mm



E27 Holder

**3D Glass Pendant D220**

## Chrome Fireworks





-  **SKU No.** PD9012
-  **E27 Holder** Max 40W
-  **Material** 3D Glass
-  **Dimension** ø220x275 mm



E27 Holder

### 3D Glass Pendant D200

#### Copper Fireworks





-  **SKU No.** PD9013
-  **E27 Holder** Max 40W
-  **Material** 3D Glass
-  **Dimension** ø200x213mm



E27 Holder

### 3D Glass Pendant D200

#### Chrome Rhombus





-  **SKU No.** PD9014
-  **E27 Holder** Max 40W
-  **Material** 3D Glass
-  **Dimension** ø200x213 mm



E27 Holder

### 3D Glass Pendant D200

#### Chrome Squares





-  **SKU No.** PD9015
-  **E27 Holder** Max 40W
-  **Material** 3D Glass
-  **Dimension** ø200x213 mm



E27 Holder

### 3D Glass Pendant D200

#### Chrome Fireworks





-  **SKU No.** PD9016
-  **E27 Holder** Max 40W
-  **Material** 3D Glass
-  **Dimension** ø200x213 mm



E27 Holder





**3D Glass Pendant D400****Copper Seagull**

-  **SKU No.** PD9017
-  **E27 Holder** Max 40W
-  **Material** 3D Glass
-  **Dimension** ø400x200 mm



E27 Holder





**3D Glass Pendant D400****Chrome Circles**

-  **SKU No.** PD9018
-  **E27 Holder** Max 40W
-  **Material** 3D Glass
-  **Dimension** ø400x200 mm



E27 Holder





**3D Glass Pendant D200****Chrome Square**

-  **SKU No.** PD9019
-  **E27 Holder** Max 40W
-  **Material** 3D Glass
-  **Dimension** ø200x165 mm



E27 Holder





**3D Glass Pendant D200****Chrome Seagull**

-  **SKU No.** PD9020
-  **E27 Holder** Max 40W
-  **Material** 3D Glass
-  **Dimension** ø200x165 mm



E27 Holder



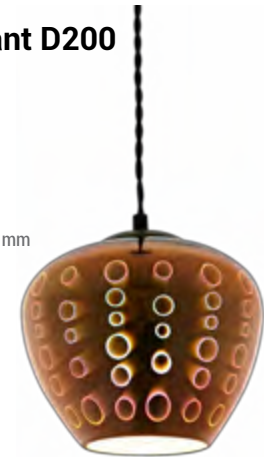

**3D Glass Pendant D200****Copper Circles**

-  **SKU No.** PD9021
-  **E27 Holder** Max 40W
-  **Material** 3D Glass
-  **Dimension** ø200x165 mm



E27 Holder





**3D Glass Pendant D290**  
Copper Circles

-  **SKU No.** PD9022
-  **E27 Holder** Max 40W
-  **Material** 3D Glass
-  **Dimension** ø290x250 mm



E27 Holder



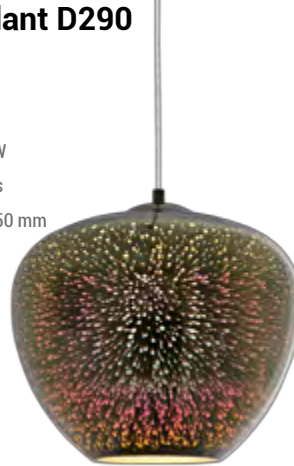

**3D Glass Pendant D290**  
Chrome Fireworks

-  **SKU No.** PD9023
-  **E27 Holder** Max 40W
-  **Material** 3D Glass
-  **Dimension** ø290x250 mm



E27 Holder



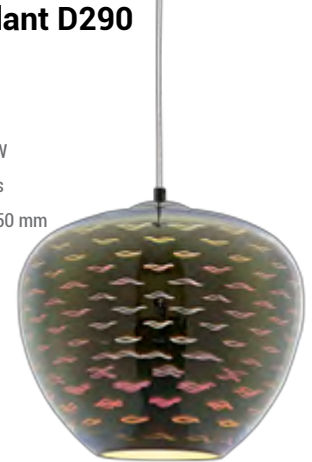

**3D Glass Pendant D290**  
Chrome Seagull

-  **SKU No.** PD9024
-  **E27 Holder** Max 40W
-  **Material** 3D Glass
-  **Dimension** ø290x250 mm



E27 Holder





**3D Glass Pendant D400**  
Chrome Fireworks

-  **SKU No.** PD9025
-  **E27 Holder** Max 40W
-  **Material** 3D Glass
-  **Dimension** ø400x345 mm



E27 Holder

**3D Glass Pendant D400**  
Copper Fireworks

-  **SKU No.** PD9026
-  **E27 Holder** Max 40W
-  **Material** 3D Glass
-  **Dimension** ø400x345 mm



E27 Holder









**LED Flame Lamp 5W SMD**

Bronze Colour



LED Lamp Included

 SKU No. OT0222

 SKU No.	PD9041
 Light Color	1300K
 Watts	5W
 Input Voltage	AC : 100-240V
 Flux	250lm
 Beam Angle	360°
 CRI	Ra>80
 IP Rating	IP20
 Dimension	ø180xH285 mm

**LED Flame Lamp 5W SMD**









Bronze Colour

With Battery



LED Lamp Included

 SKU No. OT0222

 SKU No.	PD9042
 Light Color	1300K
 Watts	5W
 Input Voltage	AC : 100-240V
 Flux	250lm
 Beam Angle	360°
 CRI	Ra>80
 IP Rating	IP20
 Dimension	ø180xH285 mm



**LED Flame Lamp 5W SMD**

Bronze Colour  
Wall Mounted



LED Lamp Included

SKU No. OT0222



SKU No. PD9044

Dimension 220xH330 mm



SKU No. PD9045

Dimension 180xH260 mm

- Light Color 1300K
- Watts 5W
- Input Voltage AC : 100-240V
- Flux 250lm
- Beam Angle 360°
- CRI Ra>80
- IP Rating IP20

Light Color	1300K
Watts	5W
Input Voltage	AC : 100-240V
Flux	250lm
Beam Angle	360°
CRI	Ra>80
IP Rating	IP20

**LED Flame Lamp 5W SMD**

Bronze Colour  
Hanging



LED Lamp Included

SKU No. OT0222



- SKU No. PD9043
- Light Color 1300K
- Watts 5W
- Input Voltage AC : 100-240V
- Flux 250lm
- Beam Angle 360°
- CRI Ra>80
- IP Rating IP20
- Dimension ø150xH330 mm

SKU No.	PD9043
Light Color	1300K
Watts	5W
Input Voltage	AC : 100-240V
Flux	250lm
Beam Angle	360°
CRI	Ra>80
IP Rating	IP20
Dimension	ø150xH330 mm





## LED PANELS AND MINI PANELS





LED panels offers a broad application it different lighting solutions. With variety of standard sizes they can be placed in suspended ceilings or used as hanging lights.

Features:

- Up to 80% power saving
- Build-in or hanging installations
- Variety of colour temperatures
- Glossy or matt finishing
- Standard sizes
- Variety of powers

Application:

- Suspended ceilings
- Indoor use – home or office
- Large spaces



IP20



120°











5 Years Warranty

### LED Panel Premium PF>0.9

With Driver - 5 Years Warranty

SDCM<6



-  **SKU No.**
-  **Light Color**
-  **Watts**
-  **Input Voltage**
-  **Flux**
-  **Beam Angle**
-  **CRI**
-  **IP Rating**
-  **Dimension**

**25W**  **3000**  
Lumens

**25W**  **3000**  **6 PCS Box**  
Lumens

**40W**  **4800**  **FLICKER FREE LED**  
Lumens

**40W**  **4000**  **FLICKER FREE LED**  
62x62 cm Lumens

SKU No.	DL2723/DL2724/DL2725
Light Color	6000K/4500K/2800K
Watts	25W
Input Voltage	AC : 175-265V
Flux	3000lm - 120lm/W
Beam Angle	120°
CRI	Ra>80
IP Rating	IP20
Dimension	595x595x10 mm

SKU No.	DL2720/DL2721/DL2722
Light Color	6000K/4500K/2800K
Watts	25W
Input Voltage	AC : 175-265V
Flux	3000lm - 120lm/W
Beam Angle	120°
CRI	Ra>80
IP Rating	IP20
Dimension	595x595x10 mm

SKU No.	DL2726/DL2727/DL2728
Light Color	6000K/4500K/2800K
Watts	40W
Input Voltage	AC : 175-265V
Flux	4800lm - 120lm/W
Beam Angle	120°
CRI	Ra>80
IP Rating	IP20
Dimension	595x595x9 mm

SKU No.	DL2731/DL2732/DL2733
Light Color	6000K/4500K/2800K
Watts	40W
Input Voltage	AC : 175-265V
Flux	4000lm - 100lm/W
Beam Angle	120°
CRI	Ra>80
IP Rating	IP20
Dimension	615x615x9 mm

Color Temperature

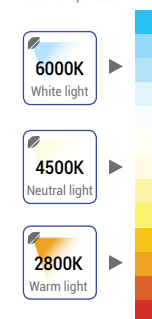

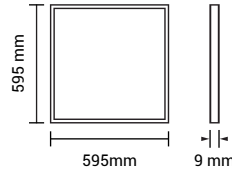

**TP(b) RATED**  
Polycarbonate Diffuser

SKU No.	DL2740/DL2741
Light Color	6000K/4000K
Watts	25W
Input Voltage	AC : 175-265V
Flux	3000lm
Beam Angle	120°
CRI	Ra>80
IP Rating	IP20
Dimension	595x595x9 mm

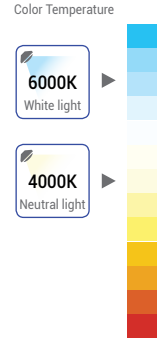

**LED Panel 25W PF>0.9**  
WITH DRIVER

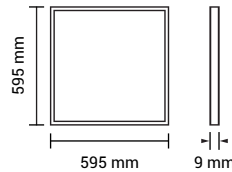

**TP(b) RATED**  
Polycarbonate Diffuser

SKU No.	DL2744/DL2745
Light Color	6000K/4000K
Watts	36W
Input Voltage	AC : 175-265V
Flux	3500lm
Beam Angle	120°
CRI	Ra>80
IP Rating	IP20
Dimension	595x595x9 mm

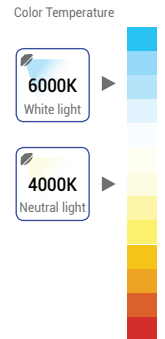

**LED Panel 36W PF>0.9**  
WITH DRIVER





### LED Panel

WITH DRIVER 60x60cm

**36W** **2500**  
Lumens

**48W** **3840**  
Lumens

**48W** **3840**  
Lumens **2 PCS Box**

- SKU No.**
- Light Color**
- Watts**
- Input Voltage**
- Flux**
- Beam Angle**
- CRI**
- IP Rating**
- Dimension**

DL2350/DL2363/DL2351

6000K/4500K/2700K

36W

AC : 175-265V

2500lm

120°

Ra>80

IP20

595x595x10 mm

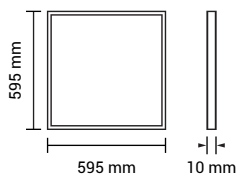

DL2367-S/DL2368-S/DL2369-S

6000K/4500K/2700K

48W

AC : 175-265V

3840lm

120°

Ra>80

IP20

595x595x9 mm

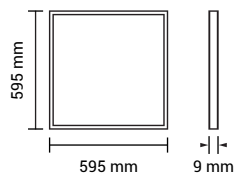

DL2367/DL2368/DL2369

6000K/4500K/2700K

48W

AC : 175-265V

3840lm

120°

Ra>80

IP20

595x695x9 mm

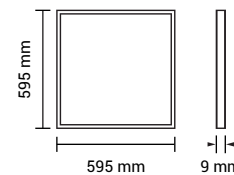

Color Temperature

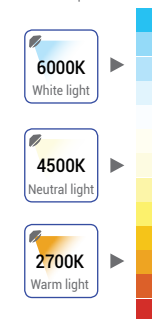

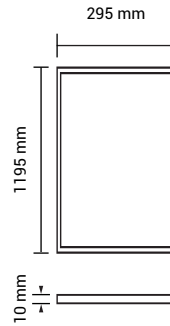

SKU No.	DL2375/DL2376/DL2377
Light Color	6000K/4500K/2700K
Watts	45W
Input Voltage	AC : 175-265V
Flux	3600lm
Beam Angle	120°
CRI	Ra>80
IP Rating	IP20
Dimension	1195x295x10 mm

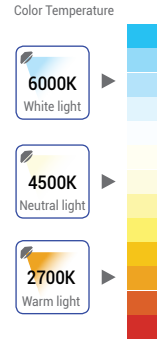

**LED Panel 45W PF>0.9**  
WITH DRIVER 120x30cm - 2pcs box

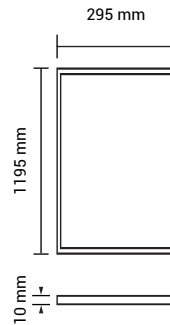

SKU No.	DL2356/DL2358/DL2357
Light Color	6000K/4500K/2700K
Watts	48W
Input Voltage	AC : 175-265V
Flux	3840lm
Beam Angle	120°
CRI	Ra>80
IP Rating	IP20
Dimension	1195x295x10 mm

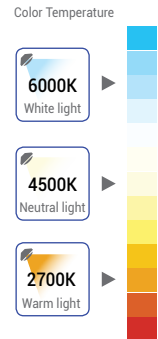

**LED Panel 48W**  
WITH DRIVER 120x30cm - 2pcs box



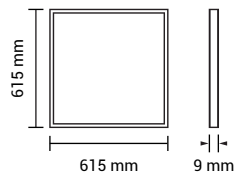

SKU No.	DL2734/DL2735/DL2736
Light Color	6000K/4500K/2800K
Watts	36W
Input Voltage	AC : 175-265V
Flux	3000lm - 85lm/W
Beam Angle	120°
CRI	Ra>80
IP Rating	IP20
Dimension	615x615x9 mm

Color Temperature

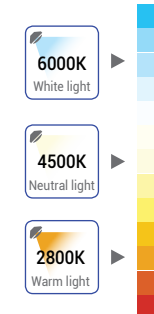

### LED Panel 36W PF>0.9

WITH DRIVER 62x62cm

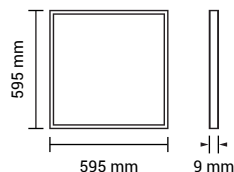

SKU No.	DL2372/DL2373/DL2374
Light Color	6000K/4500K/2700K
Watts	45W
Input Voltage	AC : 175-265V
Flux	3600lm
Beam Angle	120°
CRI	Ra>80
IP Rating	IP20
Dimension	595x595x9 mm

Color Temperature

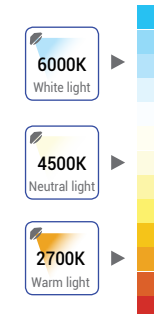

### LED Panel 45W PF>0.9

WITH DRIVER 60x60cm - 2pcs box





## Drivers for LED PANEL

Dimmable



**FOR LED PANEL 25W**  
600mA 30-42V DC

**FOR LED PANEL 36W\***  
900mA 30-42V DC

**FOR LED PANEL 45W**  
1000mA 30-45V DC

**FOR LED PANEL 48W**  
710mA 45-63V DC





**FOR LED PANEL 48W**  
1100mA 30-40V DC

	FOR LED PANEL 25W 600mA 30-42V DC	FOR LED PANEL 36W* 900mA 30-42V DC	FOR LED PANEL 45W 1000mA 30-45V DC	FOR LED PANEL 48W 710mA 45-63V DC	FOR LED PANEL 48W 1100mA 30-40V DC
SKU No.	AC6031	AC6032	AC6028	AC6013	AC6024
Output Voltage	30-42V DC	30-42V DC	30-45V DC	45-65V DC	30-40V DC
Input Voltage	AC : 180-265V	AC : 180-265V	AC : 180-265V	AC : 180-265V	AC : 180-265V
IP Rating	IP20	IP20	IP20	IP20	IP20
Dimension	140x45x30mm	140x45x30mm	140x45x30mm	140x45x30mm	140x45x30mm

\* ONLY FOR LED PANEL 36W  
DL2734 / DL2735 / DL2736





 SKU No.	AC6029
 Battery	3.6V / 4.5Ah
 IP Rating	IP20
 Dimension	213x95x40mm
 Emergency duration	3 Hours

## EMERGENCY BATTERY PACK

FOR LED PANALES





Battery

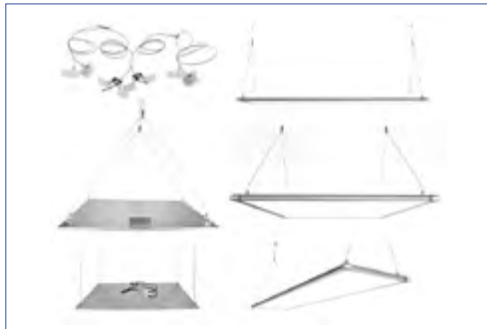

IP20

## Accessories for Hanging



 SKU No. OT5182

### Stainless Steel Cable



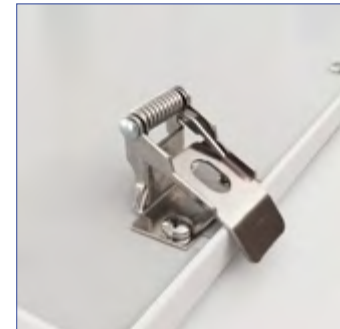

 SKU No. OT5188

### Clips for LED Panel



**Frames for LED PANELS**



 <b>SKU No.</b>	OT5195	OT5196	OT5198	OT5197
 <b>Dimension</b>	300x300mm	600x300mm	600x600mm	1200x300mm

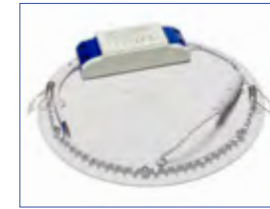

EPISTAR  
Chips



IP20



120°













5  
Years  
Warranty

### LED Mini Panel Premium PF>0.9

EMC APPROVED - ROUND

<b>3W</b>	 155 Lumens	<b>6W</b>	 420 Lumens	<b>12W</b>	 960 Lumens	<b>18W</b>	 1440 Lumens	<b>24W</b>	 1920 Lumens
-----------	--	-----------	--	------------	--	------------	---	------------	---

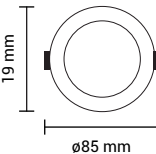
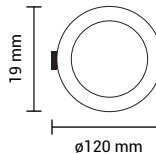
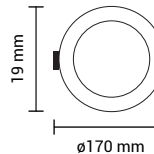
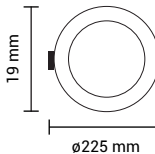
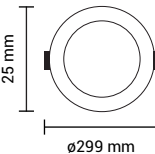
 <b>SKU No.</b>	DL2550/DL2551/DL2552	DL2553/DL2554/DL2555	DL2556/DL2557/DL2558	DL2559/DL2560/DL2561	DL2562/DL2563/DL2564
 <b>Light Color</b>	6000K/4500K/2800K	6000K/4500K/2800K	6000K/4500K/2800K	6000K/4500K/2800K	6000K/4500K/2800K
 <b>Watts</b>	3W	6W	12W	18W	24W
 <b>Input Voltage</b>	AC : 170-265V	AC : 170-265V	AC : 170-265V	AC : 170-265V	AC : 170-265V
 <b>Flux</b>	155lm	420lm	960lm	1440lm	1920lm
 <b>Beam Angle</b>	120°	120°	120°	120°	120°
 <b>CRI</b>	Ra>80	Ra>80	Ra>80	Ra>80	Ra>80
 <b>IP Rating</b>	IP20	IP20	IP20	IP20	IP20
 <b>Cutting size</b>	ø75 mm	ø110 mm	ø155 mm	ø205 mm	ø285 mm
 <b>Dimension</b>					

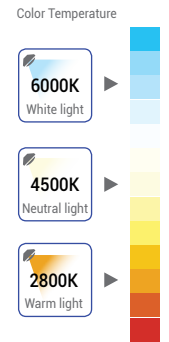



EPISTAR  
Chips



IP20



120°



5  
Years  
Warranty

**LED Mini Panel Premium PF>0.9**

EMC APPROVED - SQUARE

<b>3W</b>		<b>6W</b>		<b>12W</b>		<b>18W</b>		<b>24W</b>	
	Lumens		Lumens		Lumens		Lumens		Lumens

	DL2565/DL2566/DL2567	DL2568/DL2569/DL2570	DL2571/DL2572/DL2573	DL2574/DL2575/DL2576	DL2577/DL2578/DL2579
	6000K/4500K/2800K	6000K/4500K/2800K	6000K/4500K/2800K	6000K/4500K/2800K	6000K/4500K/2800K
	3W	6W	12W	18W	24W
	AC : 170-265V	AC : 170-265V	AC : 170-265V	AC : 170-265V	AC : 170-265V
	155lm	420lm	960lm	1440lm	1920lm
	120°	120°	120°	120°	120°
	Ra>80	Ra>80	Ra>80	Ra>80	Ra>80
	IP20	IP20	IP20	IP20	IP20
	75x75 mm	110x110 mm	155x155 mm	205x205 mm	285x285 mm
	85x85 mm	120x120 mm	167x167 mm	225x225 mm	300x300 mm

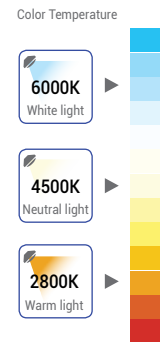





Color changing knob



IP44



100°



3  
Years  
Warranty

### CCT-Mini LED Panel

COLOR CHANGING LED 3000-4500-6000K

BUILT-IN DRIVER ROUND

**6W**



Lumens

**12W**



Lumens

**18W**













Lumens

**24W**



Lumens

-  SKU No.
-  Light Color
-  Watts
-  Input Voltage
-  Flux
-  Beam Angle
-  CRI
-  IP Rating
-  Cutting size
-  Dimension

	DL2590	DL2591	DL2592	DL2593
SKU No.	DL2590	DL2591	DL2592	DL2593
Light Color	3000K-4500K-6000K	3000K-4500K-6000K	3000K-4500K-6000K	3000K-4500K-6000K
Watts	6W	12W	18W	24W
Input Voltage	AC : 165-265V	AC : 165-265V	AC : 165-265V	AC : 165-265V
Flux	450lm	950lm	1550lm	2150lm
Beam Angle	100°	100°	100°	100°
CRI	Ra>80	Ra>80	Ra>80	Ra>80
IP Rating	IP44 Front	IP44 Front	IP44 Front	IP44 Front
Cutting size	ø105 mm	ø155 mm	ø205 mm	ø225 mm

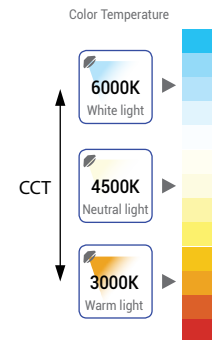
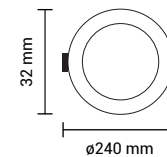
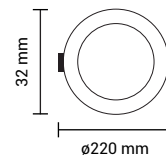
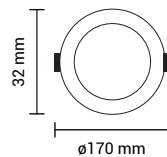
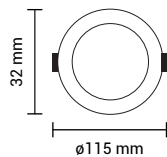



Color changing knob



IP44



100°



3 Years  
Warranty

### CCT-Mini LED Panel

COLOR CHANGING LED 3000-4500-6000K

BUILT-IN DRIVER SQUARE

6W	12W	18W	24W
450	950	1550	2150
Lumens	Lumens	Lumens	Lumens

- SKU No.
- Light Color
- Watts
- Input Voltage
- Flux
- Beam Angle
- CRI
- IP Rating
- Cutting size
- Dimension

DL2594	DL2595	DL2596	DL2597
3000K-4500K-6000K	3000K-4500K-6000K	3000K-4500K-6000K	3000K-4500K-6000K
6W	12W	18W	24W
AC : 165-265V	AC : 165-265V	AC : 165-265V	AC : 165-265V
450lm	950lm	1550lm	2150lm
100°	100°	100°	100°
Ra>80	Ra>80	Ra>80	Ra>80
IP44 Front	IP44 Front	IP44 Front	IP44 Front
105x105 mm	155x155 mm	205x205 mm	205x205 mm

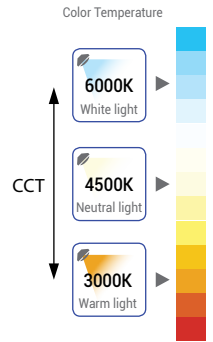
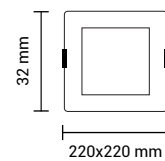
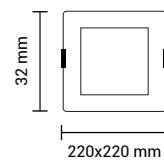
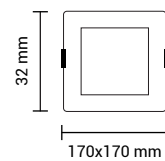
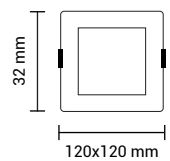



Built-in Driver



IP20



120°











## LED Mini Panel City Line

BUILT-IN DRIVER - ROUND

**6W**   
Lumens

**12W**   
Lumens

**18W**   
Lumens

-  **SKU No.**
-  **Light Color**
-  **Watts**
-  **Input Voltage**
-  **Flux**
-  **Beam Angle**
-  **CRI**
-  **IP Rating**
-  **Cutting size**
-  **Dimension**

DL2621/DL2622/DL2623
6000K/4500K/2700K
6W
AC : 95-265V
375lm
120°
Ra>80
IP20
ø110mm

DL2624/DL2625/DL2626
6000K/4500K/2700K
12W
AC : 95-265V
940lm
120°
Ra>80
IP20
ø150 mm

DL2627/DL2628/DL2629
6000K/4500K/2700K
18W
AC : 95-265V
1500lm
120°
Ra>80
IP20
ø200 mm

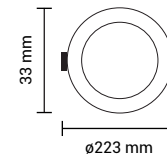
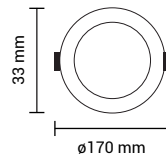
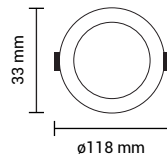

Color Temperature

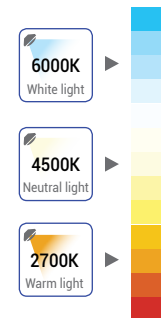



Built-in Driver



IP20



120°

## LED Mini Panel City Line

BUILT-IN DRIVER - SQUARE

**6W**



Lumens

**12W**













Lumens

**18W**



Lumens

-  **SKU No.**
-  **Light Color**
-  **Watts**
-  **Input Voltage**
-  **Flux**
-  **Beam Angle**
-  **CRI**
-  **IP Rating**
-  **Cutting size**
-  **Dimension**

DL2633/DL2634/DL2635

6000K/4500K/2700K

6W

AC : 95-265V

375lm

120°

Ra>80

IP20

100x100 mm

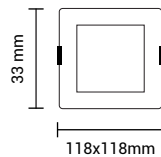

DL2636/DL2637/DL2638

6000K/4500K/2700K

12W

AC : 170-265V

940lm

120°

Ra>80

IP20

150x150 mm

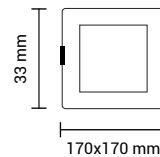

DL2639/DL2640/DL2641

6000K/4500K/2700K

18W

AC : 170-265V

1500lm

120°

Ra>80

IP20

200x200 mm

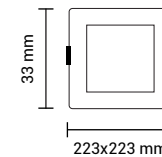

Color Temperature





### LED Mini Panel

#### ROUND

	<b>3W</b> 195 Lumens	<b>6W</b> 390 Lumens	<b>12W</b> 780 Lumens	<b>18W</b> 1170 Lumens	<b>24W</b> 1625 Lumens
--	-------------------------	-------------------------	--------------------------	---------------------------	---------------------------

<b>SKU No.</b>	DL2431/DL2432/DL2433	DL2434/DL2435/DL2436	DL2437/DL2438/DL2439	DL2335/DL2440/DL2336	DL2441/DL2442/DL2443
<b>Light Color</b>	6000K/4500K/2700K	6000K/4500K/2700K	6000K/4500K/2700K	6000K/4500K/2700K	6000K/4500K/2700K
<b>Watts</b>	3W	6W	12W	18W	24W
<b>Input Voltage</b>	AC : 180-260V	AC : 180-260V	AC : 180-260V	AC : 180-260V	AC : 180-260V
<b>Flux</b>	195lm	390lm	780lm	1170lm	1625lm
<b>Beam Angle</b>	120°	120°	120°	120°	120°
<b>CRI</b>	Ra>80	Ra>80	Ra>80	Ra>80	Ra>80
<b>IP Rating</b>	IP20	IP20	IP20	IP20	IP20
<b>Cutting size</b>	ø75 mm	ø110 mm	ø155 mm	ø205 mm	ø285 mm
<b>Dimension</b>					

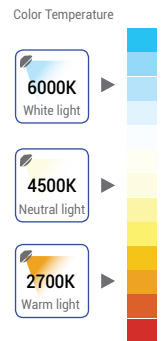

















IP20



120°

## LED Mini Panel

SQUARE

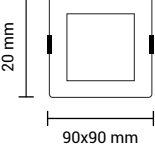
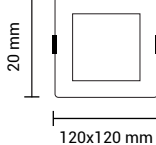
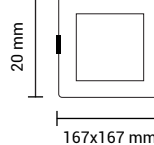
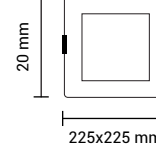
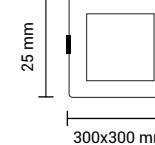
	3W 	6W 	12W 	18W 	24W 
	Lumens	Lumens	Lumens	Lumens	Lumens
 <b>SKU No.</b>	DL2444/DL2445/DL2446	DL2447/DL2448/DL2449	DL2450/DL2451/DL2452	DL2348/DL2453/DL2349	DL2454/DL2455/DL2456
 <b>Light Color</b>	6000K/4500K/2700K	6000K/4500K/2700K	6000K/4500K/2700K	6000K/4500K/2700K	6000K/4500K/2700K
 <b>Watts</b>	3W	6W	12W	18W	24W
 <b>Input Voltage</b>	AC : 180-260V	AC : 180-260V	AC : 180-260V	AC : 180-260V	AC : 180-260V
 <b>Flux</b>	195lm	390lm	780lm	1170lm	1625lm
 <b>Beam Angle</b>	120°	120°	120°	120°	120°
 <b>CRI</b>	Ra>80	Ra>80	Ra>80	Ra>80	Ra>80
 <b>IP Rating</b>	IP20	IP20	IP20	IP20	IP20
 <b>Cutting size</b>	75x75 mm	110x110 mm	155x155 mm	205x205 mm	282x282 mm
 <b>Dimension</b>					

Color Temperature

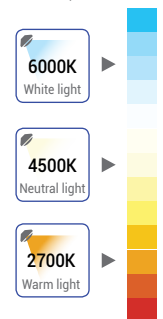



Color changing knob



IP44



100°



3 Years  
Warranty



DIMMABLE

### CCT-Mini LED Panel

COLOR CHANGING LED 3000-4500-6000K

BUILT-IN DRIVER ROUND-Dimmable

- SKU No.
- Light Color
- Watts
- Input Voltage
- Flux
- Beam Angle
- CRI
- IP Rating
- Cutting size
- Dimension

	6W	9W	16W	20W	24W
SKU No.	DL2581	DL2582	DL2583	DL2584	DL2585
Light Color	3000K-4500K-6000K	3000K-4500K-6000K	3000K-4500K-6000K	3000K-4500K-6000K	3000K-4500K-6000K
Watts	3W	6W	12W	18W	24W
Input Voltage	AC : 220-240V	AC : 220-240V	AC : 220-240V	AC : 220-240V	AC : 220-240V
Flux	450lm	650lm	1200lm	1800lm	2100lm
Beam Angle	100°	100°	100°	100°	100°
CRI	Ra>80	Ra>80	Ra>80	Ra>80	Ra>80
IP Rating	IP44 Front	IP44 Front	IP44 Front	IP44 Front	IP44 Front
Cutting size	ø105 mm	ø105 mm	ø155 mm	ø205 mm	ø225 mm
Dimension					

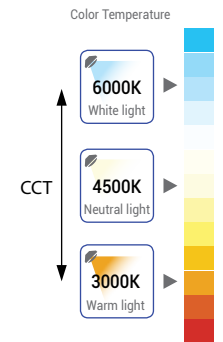



## Downlight Adapter

From Recessed Panel to Surface Panel

### SKU No.

**OT5003** Surface 3'D105 from 6W-9W  
Compatible with DL2581,DL2582

**OT5004** Surface 3'D105 from 12W-16W  
Compatible with DL2583

**OT5005** Surface 7'D205 from 18W-20W  
Compatible with DL2584

**OT5006** Surface 8'D225 from 22W-24W  
Compatible with DL2585

## Mini Panels Dimmable Drivers



DIMMABLE

### SKU No.

**AC6025** Dimmable Driver 220V 5-9\*1W 300mA

**AC6026** Dimmable Driver 220V 10-18\*1W 300mA

**AC6027** Dimmable Driver 220V 20-30\*1W 300mA





Slidable spring



Color changing knob



IP20



100°



3 Years Warranty

### LED SLIM 5in1 BUILT-IN/SURFACE

CCT LED 3000 to 6000K

**18W** **1600**  
Lumens

**30W** **3000**  
Lumens

- SKU No.
- Light Color
- Watts
- Input Voltage
- Flux
- Beam Angle
- CRI
- IP Rating
- Cutting size
- Dimension

SKU No.	DL2586
Light Color	3000K-4500K-6000K
Watts	18W
Input Voltage	AC:175-265V
Flux	1600lm
Beam Angle	100°
CRI	Ra>80
IP Rating	IP20
Cutting size	ø65-210mm

SKU No.	CB2587
Light Color	3000K-4500K-6000K
Watts	30W
Input Voltage	AC:175-265V
Flux	3000lm
Beam Angle	100°
CRI	Ra>80
IP Rating	IP20
Cutting size	ø65-310mm

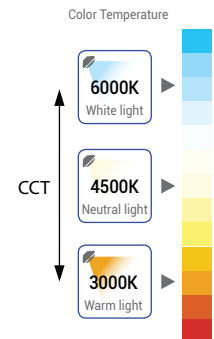
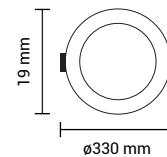
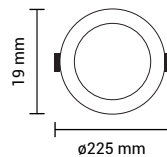



IP50



120°



DIMMABLE

**LED DOWNLIGHT Dimmable**

CCT LED 3000 to 6000K

REMOTE CONTROL AC6324 – NOT INCLUDED

**12W**



Lumens

**20W**



Lumens

- SKU No.**
- Light Color**
- Watts**
- Input Voltage**
- Flux**
- Beam Angle**
- CRI**
- IP Rating**
- Cutting size**
- Dimension**

CB3257
3000K-4500K-6000K
12W
AC:175-265V
750m
120°
Ra>80
IP50-Dust Protected
ø100mm

CB3258
3000K-4500K-6000K
20W
AC:175-265V
1400lm
120°
Ra>80
IP50-Dust Protected
ø160mm

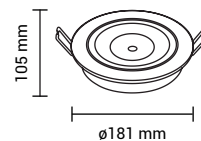
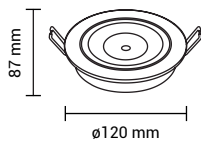

**REMOTE CONTROL**

**SKU No.** AC6324

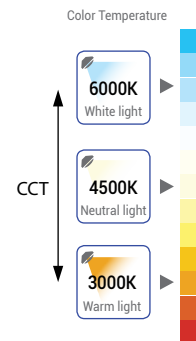

- 2.4 GHZ
- Remote 4 Groups
- up to 50 pcs per Group





LED DOWNLIGHTS



LED downlights offer a wide variety of applications, from home use as additional lights, to main or accent lighting. Applicable in homes, offices and stores.

Features:

- Up to 80% power saving
- Different sizes to fit old installations or new lighting projects
- Variety of IP ratings
- Fixed or rotatable
- Fire-rated models
- Build-in or surface installation

Application:

- Home or office use
- Accent lights for shops or stores
- Suitable for suspended ceilings



IP20



50°



EMC DRIVER

### COB Downlights

Round White - Adjustable

**5W**  
 375  
 Lumens

**7W**  
 525  
 Lumens

**10W**  
 750  
 Lumens

- SKU No.
- Light Color
- Watts
- Input Voltage
- Flux
- Beam Angle
- CRI
- IP Rating
- Cutting size
- Dimension

SKU No.	CB3264/CB3265/CB3266
Light Color	6000K/4500K/2700K
Watts	5W
Input Voltage	AC : 100-240V
Flux	375lm
Beam Angle	50°
CRI	Ra>80
IP Rating	IP20
Cutting size	ø80mm

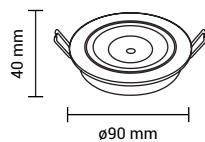

SKU No.	CB3284/CB3285/CB3286
Light Color	6000K/4500K/2700K
Watts	7W
Input Voltage	AC : 100-240V
Flux	525lm
Beam Angle	50°
CRI	Ra>80
IP Rating	IP20
Cutting size	ø80 mm

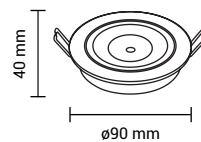

SKU No.	CB3290/CB3291/CB3292
Light Color	6000K/4500K/2700K
Watts	10W
Input Voltage	AC : 100-240V
Flux	750lm
Beam Angle	50°
CRI	Ra>80
IP Rating	IP20
Cutting size	ø105 mm

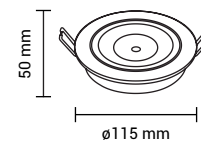

Color Temperature

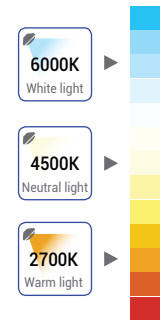





IP20



50°



EMC DRIVER

## COB Downlights

Square White - Adjustable

**5W**  
375  
Lumens

**7W**  
525  
Lumens

**10W**  
750  
Lumens

- SKU No.
- Light Color
- Watts
- Input Voltage
- Flux
- Beam Angle
- CRI
- IP Rating
- Cutting size
- Dimension

SKU No.	CB3267/CB3268/CB3269
Light Color	6000K/4500K/2700K
Watts	5W
Input Voltage	AC : 100-240V
Flux	375lm
Beam Angle	50°
CRI	Ra>80
IP Rating	IP20
Cutting size	ø80mm

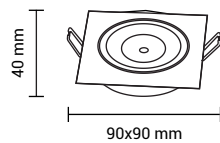

SKU No.	CB3287/CB3288/CB3289
Light Color	6000K/4500K/2700K
Watts	7W
Input Voltage	AC : 100-240V
Flux	525lm
Beam Angle	50°
CRI	Ra>80
IP Rating	IP20
Cutting size	ø80 mm

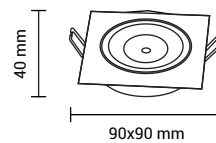

SKU No.	CB3293/CB3294/CB3295
Light Color	6000K/4500K/2700K
Watts	10W
Input Voltage	AC : 100-240V
Flux	750lm
Beam Angle	50°
CRI	Ra>80
IP Rating	IP20
Cutting size	ø105 mm

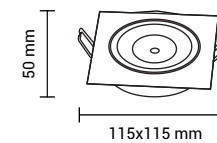

Color Temperature

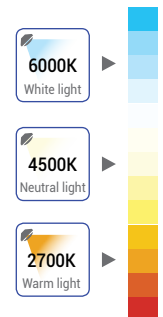



**8W COB Downlight**  
 Round White - Adjustable

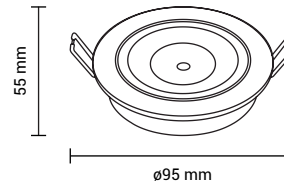

<b>SKU No.</b>	CB3201/CB3206/CB3202
<b>Light Color</b>	6000K/4500K/2800K
<b>Watts</b>	8W
<b>Input Voltage</b>	AC : 220-265V
<b>Flux</b>	640lm
<b>Beam Angle</b>	60°
<b>CRI</b>	Ra>80
<b>IP Rating</b>	IP20
<b>Dimension</b>	ø95x55 mm

Color Temperature

**6000K**  
White light

**4500K**  
Neutral light

**2800K**  
Warm light

640  
Lumens

ø80 mm



60°



IP20



**8W COB Downlight**  
 Round Inox - Adjustable

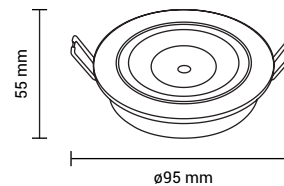

<b>SKU No.</b>	CB3203/CB3205/CB3204
<b>Light Color</b>	6000K/4500K/2800K
<b>Watts</b>	8W
<b>Input Voltage</b>	AC : 220-265V
<b>Flux</b>	640lm
<b>Beam Angle</b>	60°
<b>CRI</b>	Ra>80
<b>IP Rating</b>	IP20
<b>Dimension</b>	ø95x55 mm

Color Temperature

**6000K**  
White light

**4500K**  
Neutral light

**2800K**  
Warm light

640  
Lumens

ø80 mm



60°



IP20



**8W COB Downlight**

Square White - Adjustable

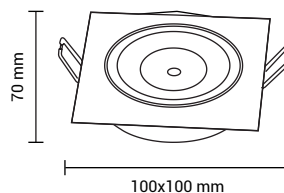

SKU No.	CB3207/CB3222/CB3212
Light Color	6000K/4500K/2800K
Watts	8W
Input Voltage	AC : 220-265V
Flux	640lm
Beam Angle	60°
CRI	Ra>80
IP Rating	IP20
Dimension	100x100x70 mm

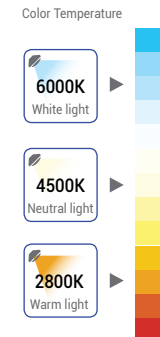

640 Lumens    ø80 mm    60°    IP20



**8W COB Downlight**

Square Inox - Adjustable

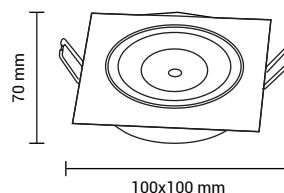

SKU No.	CB3223/CB3224/CB3225
Light Color	6000K/4500K/2800K
Watts	8W
Input Voltage	AC : 220-265V
Flux	640lm
Beam Angle	60°
CRI	Ra>80
IP Rating	IP20
Dimension	100x100x70 mm

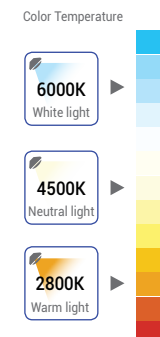

640 Lumens    ø80 mm    60°    IP20



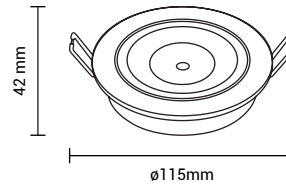

**12W COB Downlight**  
Round - Adjustable

SKU No.	CB3251/CB3252/CB3253
Light Color	6000K/4500K/2800K
Watts	12W
Input Voltage	AC : 200-265V
Flux	960lm
Beam Angle	60°
CRI	Ra>80
IP Rating	IP20
Dimension	ø115x42 mm

Color Temperature

6000K  
White light

4500K  
Neutral light

2800K  
Warm light

960  
Lumens

ø105 mm



60°



IP20

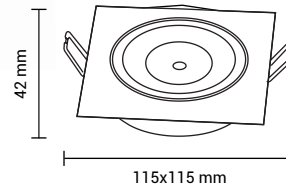

**12W COB Downlight**  
Square- Adjustable

SKU No.	CB3254/CB3255/CB3256
Light Color	6000K/4500K/2800K
Watts	12W
Input Voltage	AC : 200-265V
Flux	960lm
Beam Angle	60°
CRI	Ra>80
IP Rating	IP20
Dimension	115x115x42 mm

Color Temperature

6000K  
White light

4500K  
Neutral light

2800K  
Warm light

960  
Lumens

ø105 mm



60°



IP20



**25W COB Downlight**  
Round - Adjustable

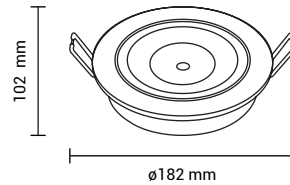

SKU No.	CB3241/CB3242
Light Color	6000K/4500K
Watts	25W
Input Voltage	AC : 200-265V
Flux	2200lm
Beam Angle	60°
CRI	Ra>80
IP Rating	IP20
Dimension	ø182x102 mm

Color Temperature

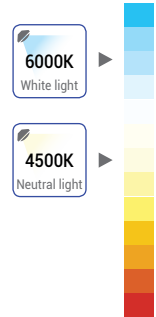

2200 Lumens    
 ø160 mm    
 60°    
 IP20



**35W COB Downlight**  
Round- Adjustable

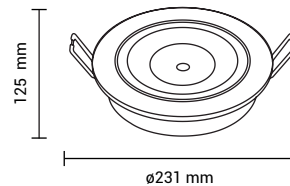

SKU No.	CB3243/CB3244
Light Color	6000K/4500K
Watts	35W
Input Voltage	AC : 200-265V
Flux	3000lm
Beam Angle	60°
CRI	Ra>80
IP Rating	IP20
Dimension	ø231x125 mm

Color Temperature

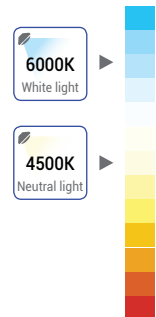

3000 Lumens    
 ø210 mm    
 60°    
 IP20



IP20



145°













### LED COB Downlight

Round - TÜV

**15W**   
Lumens

**20W**   
Lumens

**30W**   
Lumens

-  SKU No.
-  Light Color
-  Watts
-  Input Voltage
-  Flux
-  Beam Angle
-  CRI
-  IP Rating
-  Cutting size
-  Dimension

SKU No.	CB3270/CB3271/CB3272
Light Color	6000K/4500K/2800K
Watts	15W
Input Voltage	AC : 180-265V
Flux	1200lm
Beam Angle	145°
CRI	Ra>80
IP Rating	IP20
Cutting size	ø155mm

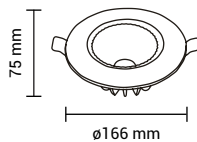

SKU No.	CB3273/CB3274/CB3275
Light Color	6000K/4500K/2800K
Watts	20W
Input Voltage	AC :180-265V
Flux	1600lm
Beam Angle	145°
CRI	Ra>80
IP Rating	IP20
Cutting size	ø165 mm

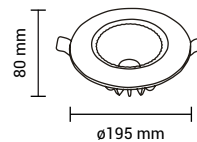

SKU No.	CB3276/CB3277/CB3278
Light Color	6000K/4500K/2800K
Watts	30W
Input Voltage	AC : 180-265V
Flux	2500lm
Beam Angle	145°
CRI	Ra>80
IP Rating	IP20
Cutting size	ø195 mm

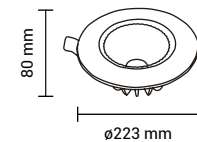

Color Temperature

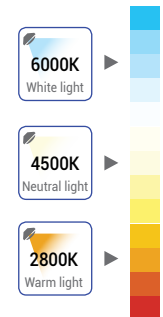

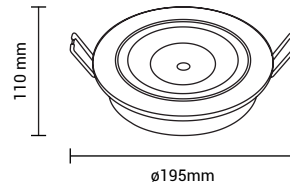

**40W COB Downlight**  
Round - TÜV

SKU No.	CB3260/CB3261
Light Color	6000K/4500K
Watts	40W
Input Voltage	AC : 200-265V
Flux	4000lm
Beam Angle	60°
CRI	Ra>80
IP Rating	IP20
Dimension	ø195x110 mm

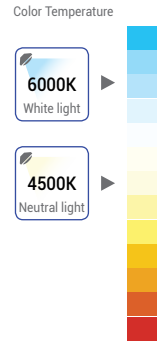

4000 Lumens    
 ø175 mm    
 60°    
 IP20

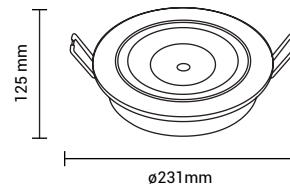

**60W COB Downlight**  
Round - TÜV

SKU No.	CB3262/CB3263
Light Color	6000K/4500K
Watts	60W
Input Voltage	AC : 200-265V
Flux	5600lm
Beam Angle	60°
CRI	Ra>80
IP Rating	IP20
Dimension	ø231x125 mm

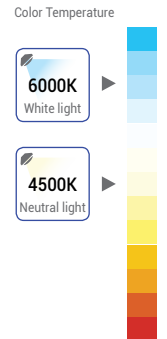

5600 Lumens    
 ø205 mm    
 60°    
 IP20



SKU No.	OT5044
Light Color	3000K-4500-6000K
Watts	10W
Input Voltage	AC : 200-240V
Flux	750lm
Beam Angle	40°
CRI	Ra>80
IP Rating	IP65
Dimension	ø84x67 mm

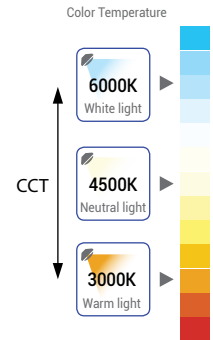

**FIRE-RATED 10W LED PF>0.9**  
CCT LED 3000K to 6000K



CHROME BEZEL FOR OT5044



SKU No. OT5045

BRUSHED BEZEL FOR OT5044



SKU No. OT5046



Magnetic replaceable covers

**FIRE-RATED 6W SMD LED PF>0.9**

Replacable covers

SKU No.	OT5041/OT5042
Light Color	2800K/4500K
Watts	6W
Input Voltage	AC : 200-265V
Flux	540lm
Beam Angle	40°
CRI	Ra>80
IP Rating	IP65
Dimension	ø84x67 mm

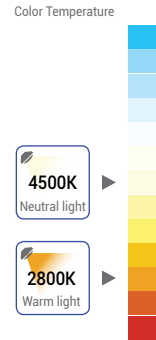
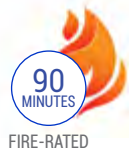

Magnetic replaceable covers



CCT Knob

**FIRE-RATED 8W COB LED PF>0.9**

CCT LED 3000K to 6000K

SKU No.	OT5043
Light Color	3000K-4500-6000K
Watts	8W
Input Voltage	AC : 175-265V
Flux	570-630lm
Beam Angle	40°
CRI	Ra>80
IP Rating	IP65
Dimension	ø80x80 mm

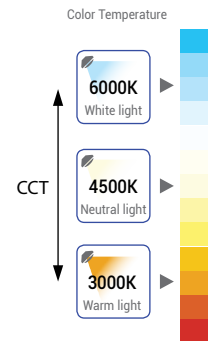



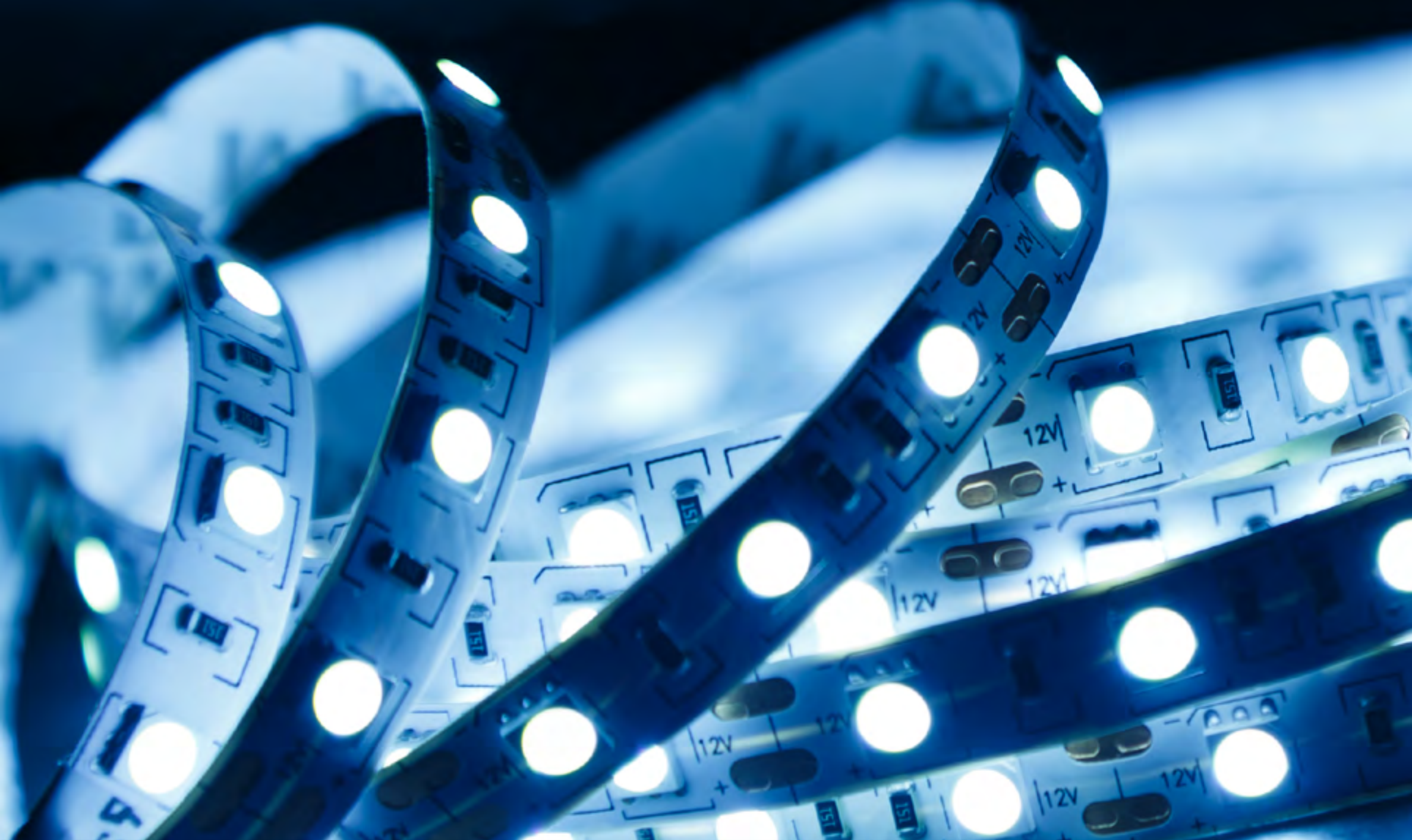

## **LED STRIPS AND ACCESSORIES**





LED Strips are a flexible solution for wide variety of lighting applications, both for indoor and outdoor projects, allowing for variable shapes and abstract forms. Functioning as a core or supplementary lighting, LED strips become a common choice of lighting professionals.

**Features:**

- Up to 80% power saving
- Flexible and reliable
- Wide choice of colour – single colour light to RGB
- Variety of IP ratings
- Options for dimming and control









**Application:**

- Indoor and outdoor lighting projects
- Applicable for abstract forms and shapes
- Hidden or ambient light

 Width  
 8 mm







### LED STRIP 12V 2835 60 SMD/m

4.8W/m - Non Waterproof

	Type LED	SMD 2835
	LEDs/m	60 pcs
	Power per Meter	4.8W/m
	Voltage	DC : 12V
	Flux per watt	50lm/W
	Beam Angle	120°
	IP Rating	IP20
	Dimension	5000x8x2 mm











SKU No. Color Temperature

ST4702	
ST4700	
ST4703	
ST4704	
ST4705	
ST4706	

 Width  
 8 mm



### LED STRIP 12V 2835 120 SMD/m

9.6W/m - Non Waterproof

	Type LED	SMD 2835
	LEDs/m	120 pcs
	Power per Meter	9.6W/m
	Voltage	DC : 12V
	Flux per watt	50lm/W
	Beam Angle	120°
	IP Rating	IP20
	Dimension	5000x8x2 mm



SKU No. Color Temperature

ST4710	
ST4740	
ST4711	



Width  
10 mm

**LED STRIP 12V 2835 204 SMD/m**  
16.5W/m - Non Waterproof

	Type LED	SMD 2835
	LEDs/m	204 pcs
	Power per Meter	16.5W/m
	Voltage	DC : 12V
	Flux per watt	50lm/W
	Beam Angle	120°
	IP Rating	IP20
	Dimension	5000x10x2 mm

204pcs	5m-Roll	IP20

**SKU No.** Color Temperature

<b>ST4761</b>		
<b>ST4762</b>		
<b>ST4763</b>		



Width  
12 mm

**LED STRIP 12V 5050 60 SMD/m RGB**  
14.4W/m - Non Waterproof

	Type LED	SMD 5050
	LEDs/m	60 pcs
	Power per Meter	14.4W/m
	Voltage	DC : 12V
	Flux per watt	100lm/W
	Beam Angle	120°
	IP Rating	IP20
	Dimension	5000x12x2 mm

60cs	5m-Roll	IP20

**SKU No.** RGB

<b>ST4313</b>		
<b>ST4314</b>		



Width  
10 mm

<b>SKU No.</b>	ST4311	ST4315
<b>Type LED</b>	SMD 5050	SMD 5050
<b>LEDs/m</b>	30 pcs	30 pcs
<b>Power per Meter</b>	7.2W/m	7.2W/m
<b>Voltage</b>	DC : 12V	DC : 12V
<b>Flux per watt</b>	70lm/W	70lm/W
<b>Beam Angle</b>	120°	120°
<b>IP Rating</b>	IP20	IP54
<b>Dimension</b>	5000x10x2 mm	5000x10x2.5 mm



**LED STRIP 12V 5050 30 SMD/m RGB**  
7.2W/m



Width  
10 mm

<b>SKU No.</b>	ST4312	ST4316
<b>Type LED</b>	SMD 5050	SMD 5050
<b>LEDs/m</b>	60 pcs	60 pcs
<b>Power per Meter</b>	14.4W/m	14.4W/m
<b>Voltage</b>	DC : 12V	DC : 12V
<b>Flux per watt</b>	70lm/W	70lm/W
<b>Beam Angle</b>	120°	120°
<b>IP Rating</b>	IP20	IP54
<b>Dimension</b>	5000x10x2 mm	5000x10x2.5 mm











**LED STRIP 12V 5050 60 SMD/m RGB**  
14.4W/m







Width  
10 mm

 Type LED	SMD 5050
 LEDs/m	60 pcs
 Power per Meter	14.4W/m
 Voltage	DC : 24V
 Flux per watt	100lm/W
 Beam Angle	120°
 IP Rating	IP20 ; IP54
 Dimension	5000x10x2.5 mm

SKU No. **ST4861**



**LED STRIP 24V 5050 60 SMD/m RGB**

14.4W/m - Non Waterproof

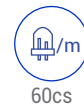

SKU No. **ST4862**





Width  
8 mm

**LED STRIP 12V 2835 60 SMD/m**  
4.8W/m - Waterproof

	Type LED	SMD 2835
	LEDs/m	60 pcs
	Power per Meter	4.8W/m
	Voltage	DC : 12V
	Flux per watt	50lm/W
	Beam Angle	120°
	IP Rating	IP54
	Dimension	5000x8x2.5 mm

60pcs

5m-Roll

IP54

SKU No. Color Temperature

ST4732		6000K White light
ST4731		4500K Neutral light
ST4733		2700K Warm light
ST4734		RED
ST4735		GREEN
ST4736		BLUE



Width  
8 mm

**LED STRIP 12V 2835 120 SMD/m**  
9.6W/m - Waterproof

	Type LED	SMD 2835
	LEDs/m	120 pcs
	Power per Meter	9.6W/m
	Voltage	DC : 12V
	Flux per watt	50lm/W
	Beam Angle	120°
	IP Rating	IP54
	Dimension	5000x8x2.5 mm

120pcs

5m-Roll

IP54

SKU No. Color Temperature

ST4720		6000K White light
ST4721		2700K Warm light



Width  
10 mm

**LED STRIP 12V 5050 30 SMD/m**  
7.2W/m - Non Waterproof

	Type LED	SMD 2835
	LEDs/m	30 pcs
	Power per Meter	7.2W/m
	Voltage	DC : 12V
	Flux per watt	50lm/W
	Beam Angle	120°
	IP Rating	IP20
	Dimension	5000x10x2 mm

30pcs

5m-Roll

IP20

SKU No.	Color Temperature
ST4801	<b>6000K</b> White light
ST4800	<b>4500K</b> Neutral light
ST4802	<b>2700K</b> Warm light



Width  
10 mm

**LED STRIP 12V 5050 60 SMD/m**  
14.4W/m - Non Waterproof

	Type LED	SMD 5050
	LEDs/m	60 pcs
	Power per Meter	14.4W/m
	Voltage	DC : 12V
	Flux per watt	50lm/W
	Beam Angle	120°
	IP Rating	IP20
	Dimension	5000x10x2 mm

60pcs

5m-Roll

IP20

SKU No.	Color Temperature
ST4807	<b>6000K</b> White light
ST4827	<b>4500K</b> Neutral light
ST4808	<b>2700K</b> Warm light
ST4823	<b>RED</b>
ST4825	<b>BLUE</b>



Width  
10 mm

**LED STRIP 12V 5050 30 SMD/m**  
7.2W/m - Waterproof

	Type LED	SMD 5050
	LEDs/m	30 pcs
	Power per Meter	7.2W/m
	Voltage	DC : 12V
	Flux per watt	50lm/W
	Beam Angle	120°
	IP Rating	IP54
	Dimension	5000x10x2.5 mm

30pcs    
 5m-Roll    
 IP54

**SKU No.** Color Temperature

**ST4809** 6000K White light

**ST4811** 4500K Neutral light

**ST4810** 2700K Warm light



Width  
10 mm

**LED STRIP 12V 5050 60 SMD/m**  
14.4W/m - Waterproof

	Type LED	SMD 5050
	LEDs/m	60 pcs
	Power per Meter	14.4W/m
	Voltage	DC : 12V
	Flux per watt	50lm/W
	Beam Angle	120°
	IP Rating	IP54
	Dimension	5000x10x2.5 mm

60pcs    
 5m-Roll    
 IP54

**SKU No.** Color Temperature

**ST4839** 6000K White light

**ST4841** 4500K Neutral light

**ST4840** 2700K Warm light





Width  
8 mm

	Type LED	SMD 3014
	LEDs/m	120 pcs
	Power per Meter	12W/m
	Voltage	DC : 12V
	Flux per watt	70lm/W
	Beam Angle	120°
	IP Rating	IP20
	Dimension	5000x8x2 mm

SKU No.	Color Temperature
ST4901	 6000K White light
ST4903	 4500K Neutral light
ST4902	 2700K Warm light

**LED STRIP 12V 3014 120 SMD/m**  
12W/m - Non Waterproof

	120pcs		5m-Roll		IP20
--	--------	--	---------	--	------



Width  
10 mm

	Type LED	SMD 5630
	LEDs/m	60 pcs
	Power per Meter	12W/m
	Voltage	DC : 12V
	Flux per watt	70lm/W
	Beam Angle	120°
	IP Rating	IP20
	Dimension	5000x10x2 mm

SKU No.	Color Temperature
ST4911	 6000K White light
ST4913	 4500K Neutral light
ST4912	 2700K Warm light

**LED STRIP 12V 5630 60 SMD/m**  
12W/m - Non Waterproof

	60pcs		5m-Roll		IP20
--	-------	--	---------	--	------



Width  
10 mm

	Type LED	SMD 2835
	LEDs/m	120 pcs
	Power per Meter	9.6W/m
	Voltage	DC : 24V
	Flux per watt	50lm/W
	Beam Angle	120°
	IP Rating	IP20
	Dimension	5000x10x2.5 mm

SKU No. Color Temperature

ST4856



ST4857



ST4858



120pcs



5m-Roll



IP20

## LED STRIP 24V 2835 120 SMD/m

9.6W/m - Non Waterproof



Width  
10 mm

	Type LED	SMD 5050
	LEDs/m	60 pcs
	Power per Meter	14.4W/m
	Voltage	DC : 24V
	Flux per watt	50lm/W
	Beam Angle	120°
	IP Rating	IP20
	Dimension	5000x10x2mm

SKU No. Color Temperature

ST4851



ST4850



ST4852



60pcs



5m-Roll



IP20

## LED STRIP 24V 5050 60 SMD/m

14.4W/m - Non Waterproof



Width  
10 mm

	Type LED	SMD 5050
	LEDs/m	60 pcs
	Power per Meter	14.4W/m
	Voltage	DC : 24V
	Flux per watt	50lm/W
	Beam Angle	120°
	IP Rating	IP54
	Dimension	5000x10x3 mm

SKU No. Color Temperature

ST4853 6000K White light

ST4854 4500K Neutral light

ST4855 2700K Warm light

**LED STRIP 24V 5050 60 SMD/m**  
14.4W/m - Waterproof

60pcs

5m-Roll

IP54



	Type LED	SMD 5025
	LEDs/m	60 pcs
	Power per Meter	16W/m
	Voltage	DC : 24V
	Flux per watt	50lm/W
	Beam Angle	120°
	IP Rating	IP20 ; IP65
	Dimension	5000x10x2 mm



SKU No. ST4441

3000K to 6000K Adjustable CT



SKU No. ST4471

3000K to 6000K Adjustable CT

**LED STRIP 24V 5025 60 SMD/m**  
6W/m - CCT Adjustable

3 Years Warranty

780 Lumens/m

60pcs

5m-Roll



Width  
12 mm

	Type LED	SMD 2835
	LEDs/m	196 pcs
	Power per Meter	20W/m
	Voltage	DC : 12V
	Flux per watt	100lm/W
	Beam Angle	120°
	IP Rating	IP20
	Dimension	5000x12x2 mm

SKU No. Color Temperature

ST4424



ST4425



ST4426



**LED STRIP 12V 2835 196 SMD/m**

20W/m - Non Waterproof  
Premium

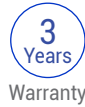

Width  
12 mm

	Type LED	SMD 2835
	LEDs/m	196 pcs
	Power per Meter	20W/m
	Voltage	DC : 12V
	Flux per watt	100lm/W
	Beam Angle	120°
	IP Rating	IP65
	Dimension	5000x12x2.5mm

SKU No. Color Temperature

ST4454



ST4455



ST4456



**LED STRIP 12V 2835 196 SMD/m**

20W/m - Waterproof  
Premium





Type LED	SMD 5050
LEDs/m	60 pcs
Power per Meter	16W/m
Voltage	DC : 12V
Flux per watt	100lm/W
Beam Angle	120°
IP Rating	IP20
Dimension	5000x10x2 mm

**SKU No.**  
ST4485

RGB



RGB+WH

**SKU No.**  
ST4486

RGB



RGB+WW

**LED STRIP 12V 5050 60 SMD/m**  
16W/m - Non Waterproof  
Premium

3 Years Warranty  
 60pcs  
 5m-Roll  
 IP20



Type LED	SMD 5050
LEDs/m	60 pcs
Power per Meter	16W/m
Voltage	DC : 12V
Flux per watt	100lm/W
Beam Angle	120°
IP Rating	IP65
Dimension	5000x10x2 mm

**SKU No.**  
ST4487

RGB



RGB+WH

**SKU No.**  
ST4488

RGB



RGB+WW

**LED STRIP 12V 5050 60 SMD/m**  
16W/m - Waterproof  
Premium

3 Years Warranty  
 60pcs  
 5m-Roll  
 IP65





Width  
12 mm

	Type LED	SMD 2835
	LEDs/m	196 pcs
	Power per Meter	20W/m
	Voltage	DC : 24V
	Flux per watt	100lm/W
	Beam Angle	120°
	IP Rating	IP20
	Dimension	5000x12x2 mm

<b>SKU No.</b>	Color Temperature
ST4421	<p>6000K White light</p>
ST4422	<p>4500K Neutral light</p>
ST4423	<p>2800K Warm light</p>

**LED STRIP 24V 2835 196 SMD/m**

20W/m - Non Waterproof  
Premium

3 Years  
Warranty

196pcs

5m-Roll

IP20



Width  
12 mm

	Type LED	SMD 2835
	LEDs/m	196 pcs
	Power per Meter	20W/m
	Voltage	DC : 24V
	Flux per watt	100lm/W
	Beam Angle	120°
	IP Rating	IP65
	Dimension	5000x12x2.5mm

<b>SKU No.</b>	Color Temperature
ST4451	<p>6000K White light</p>
ST4452	<p>4500K Neutral light</p>
ST4453	<p>2800K Warm light</p>

**LED STRIP 24V 2835 196 SMD/m**

20W/m - Waterproof  
Premium

3 Years  
Warranty

196pcs

5m-Roll

IP65





Width  
12 mm

	Type LED	SMD 5054
	LEDs/m	60 pcs
	Power per Meter	16W/m
	Voltage	DC : 24V
	Flux per watt	70lm/W
	Beam Angle	120°
	IP Rating	IP20
	Dimension	5000x10x2 mm



3  
Years  
Warranty



60pcs



5m-Roll



IP20

**LED STRIP 24V 5054 60 SMD/m**

16W/m - Non Waterproof  
Premium

SKU No.

Color Temperature

ST4431



ST4432



ST4433



Width  
12 mm

	Type LED	SMD 5054
	LEDs/m	60 pcs
	Power per Meter	16W/m
	Voltage	DC : 24V
	Flux per watt	70lm/W
	Beam Angle	120°
	IP Rating	IP65
	Dimension	5000x10x2.5mm



3  
Years  
Warranty



60pcs



5m-Roll



IP65

**LED STRIP 24V 5054 60 SMD/m**

16W/m - Waterproof  
Premium

SKU No.

Color Temperature

ST4461



ST4462



ST4463





Width  
10 mm

	Type LED	SMD 5050
	LEDs/m	60 pcs
	Power per Meter	16W/m
	Voltage	DC : 24V
	Flux per watt	100lm/W
	Beam Angle	120°
	IP Rating	IP20
	Dimension	5000x10x2 mm

**SKU No.**  
ST4481  
RGB+WH

RGB  
+  
**6000K**  
White light

**SKU No.**  
ST4482  
RGB+WW

RGB  
+  
**2800K**  
White light

**3**  
Years  
Warranty

60pcs

5m-Roll

IP20

**LED STRIP 24V 5050 60 SMD/m**

16W/m - Non Waterproof  
Premium



Width  
10 mm

	Type LED	SMD 5050
	LEDs/m	60 pcs
	Power per Meter	16W/m
	Voltage	DC : 24V
	Flux per watt	100lm/W
	Beam Angle	120°
	IP Rating	IP65
	Dimension	5000x10x2.5mm

**SKU No.**  
ST4483  
RGB+WH

RGB  
+  
**6000K**  
White light

**SKU No.**  
ST4484  
RGB+WW

RGB  
+  
**2800K**  
White light

**3**  
Years  
Warranty

60pcs

5m-Roll

IP65

**LED STRIP 24V 5050 60 SMD/m**

16W/m - Waterproof  
Premium







SMD 2216



SMD 2110



5m-Roll



IP20



3 Years  
Warranty

## LED STRIP 24V HIGH POWER

SMD2216 ; SMD2110

Premium



Lumens/m



240pcs



Lumens/m



300pcs



Lumens/m



560pcs



Lumens/m



700pcs



SKU No.

ST4403

ST4404

ST4405

ST4406



Type LED

SMD 2216

SMD 2216

SMD 2110

SMD 2110



LEDs/m

240 pcs

300 pcs

560 pcs

700 pcs



Power per Meter

22W/m

24W/m

32W/m

38W/m



Voltage

DC : 24V

DC : 24V

DC : 24V

DC : 24V



Flux per watt

85lm/W

90lm/W

80lm/W

90lm/W



Beam Angle

120°

120°

120°

120°



IP Rating

IP20

IP20

IP20

IP20



Dimension

5000x10x2 mm

5000x10x2 mm

5000x12x2 mm

5000x12x2 mm

Color Temperature

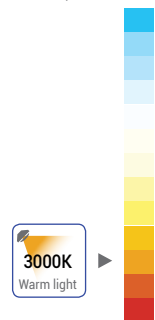

**NEW**









5m-Roll



IP20

3  
Years  
Warranty**LED DIGITAL STRIP**

Addressable

 SKU No.	ST4490	ST4491	ST4492
 Type LED	WS2811 10 Pixels	WS2812b 30 Pixels	WS2812b 60 Pixels
 LEDs/m	30 pcs	30 pcs	60 pcs
 Power per Meter	7W/m	8W/m	16W/m
 Voltage	DC : 12V	DC : 5V	DC : 5V
 Flux per watt	75lm/W	75lm/W	75lm/W
 Beam Angle	120°	120°	120°
 IP Rating	IP20	IP20	IP20
 Dimension	5000x10x2 mm	5000x10x2.5 mm	5000x10x2 mm

RGB





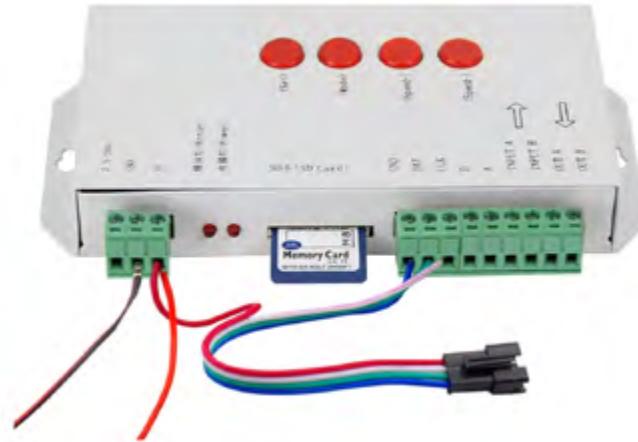

Addressable









**DIGITAL LED STRIP CONTROLLER**  
DC5-24V SD-CARD

-  **SKU No.** AC6331
-  **Voltage** 5V-24V
-  **IP Rating** IP20
-  **Dimension** 80x55x20mm

**DIGITAL LED STRIP CONTROLLER**  
14KEY DC5-24V



-  **SKU No.** AC6332
-  **Voltage** 5V-24V
-  **IP Rating** IP20
-  **Dimension** 85x40x6mm



Width  
10 mm

	Type LED	SMD 5730
	LEDs/m	120 pcs
	Power per Meter	10W/m
	Voltage	AC : 220V
	Flux per watt	50lm/W
	Beam Angle	120°
	IP Rating	IP44
	Dimension	13x5 mm

**SKU No.** Color Temperature

**ST4611** 6000K White light

**ST4612** 2800K Warm light

**LED STRIP 220V - 50m Roll**

5730 120 SMD/M



120pcs



50m-Roll



IP44



2835/5730 INPUT CABLE + CONNECTOR + PLUG

**SKU No.** AC6631



2835/5730 MIDDLE CONNECTOR









**SKU No.** AC6633













2835/5730 FIXING

**SKU No.** AC6632



	Type LED	SMD 2835
	LEDs/m	120 pcs
	Power per Meter	8.5W/m
	Voltage	AC : 220V
	Flux per watt	50lm/W
	Beam Angle	120°
	IP Rating	IP44
	Dimension	Single 16x10 mm RGB 25x13 mm

SKU No.	Color Temperature
ST4581	6000K 
ST4580	4000K 
ST4582	2700K 
ST4584	Red 
ST4585	Green 
ST4583	Blue 
ST4587	Yellow 
ST4586	Amber 
ST4588	Pink 
ST4589	RGB 

**LED FLEX NEON 220V - 50m Roll**

2835 120 SMD/M

		
120pcs	50m-Roll	IP44



INPUT CABLE + CONNECTOR + PLUG  
SKU No. AC6635



MIDDLE CONNECTOR  
SKU No. AC6634



ALUMINIUM CHANNEL WITH 2 SCREWS  
SKU No. AC6636



END CAP FOR SINGLE COLOUR  
SKU No. AC6637



POWER CABLE+RGB CONTROLLER  
SKU No. AC6638



ALUMINIUM CHANNEL , 5CM RGB  
SKU No. AC6639



END CAP FOR RGB  
SKU No. AC6640

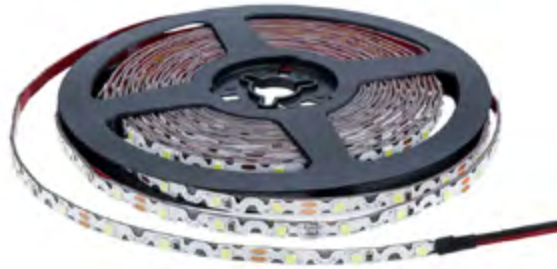

Width  
7mm

**LED STRIP S-TYPE 12V 2835 60 SMD/m**  
7.2W/m - Non Waterproof

	Type LED	SMD 2835
	LEDs/m	60 pcs
	Power per Meter	7.2W/m
	Voltage	DC : 12V
	Flux per watt	70lm/W
	Beam Angle	120°
	IP Rating	IP20
	Dimension	5000x7x2m

60pcs	5m-Roll	IP20

SKU No. Color Temperature

MO4541	6000K	
MO4546	4000K	
MO4542	2700K	
MO4543	RED	
MO4545	GREEN	
MO4544	BLUE	



Width  
7 mm

**LED STRIP S-TYPE 12V 2835 60 SMD/m**  
7.2W/m - Waterproof

	Type LED	SMD 2835
	LEDs/m	60 pcs
	Power per Meter	7.2W/m
	Voltage	DC : 12V
	Flux per watt	70lm/W
	Beam Angle	120°
	IP Rating	IP65
	Dimension	5000x7x2 mm

60pcs	5m-Roll	IP65

SKU No. Color Temperature

MO4551	6000K White light	
MO4552	2700K Warm light	
MO4553	RED	
MO4555	GREEN	
MO4554	BLUE	







**LENS LED MODULE 1W**  
3x2835 SMD - Waterproof

	Type LED	SMD 2835
	LEDs/Module	3 pcs
	Power per Module	1W
	Voltage	DC : 12V
	Flux per watt	80lm/W
	Beam Angle	160°
	IP Rating	IP65
	Dimension	58x12 m



<b>SKU No.</b>	Color Temperature
MO4512	10 000K
MO4511	6500K
MO4513	3000K
MO4514	RED
MO4516	GREEN
MO4515	BLUE

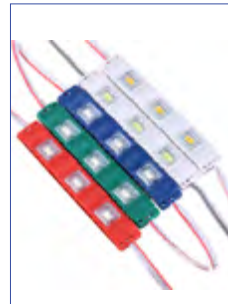

**LENS LED MODULE 1.5W**  
3x2835 SMD - Waterproof

	Type LED	SMD 2835
	LEDs/Module	3 pcs
	Power per Meter	1.5W/m
	Voltage	DC : 12V
	Flux per watt	80lm/W
	Beam Angle	160°
	IP Rating	IP65
	Dimension	75x15 m



<b>SKU No.</b>	Color Temperature
MO4522	10 000K
MO4521	6500K
MO4523	3000K
MO4524	RED
MO4526	GREEN
MO4525	BLUE





**LED MODULE 0.36W**  
 3x3014 SMD - Waterproof

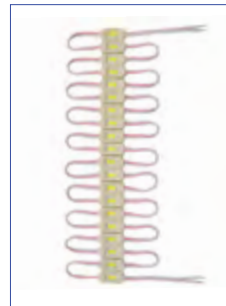

Type LED	SMD 3014
LEDs/Module	3 pcs
Power per Module	0.36W
Voltage	DC : 12V
Flux per watt	85lm/W
Beam Angle	120°
IP Rating	IP65
Dimension	18x8x2.9 mm



Lumens



IP65

**SKU No.** Color Temperature

MO4531

6500K

MO4532

3000K

MO4533

RED

MO4535

GREEN

MO4534

BLUE



**LED MODULE 2.4W**  
 4x2835 SMD - Waterproof



Type LED	SMD 2835
LEDs/Module	4 pcs
Power per Module	2.4W
Voltage	DC : 12V
Flux per watt	85lm/W
Beam Angle	160°
IP Rating	IP65
Dimension	43x38x6.5 mm



Lumens



IP65

**SKU No.** Color Temperature









MO4561

6500K

MO4562

3000K



 Type LED	SMD 3014
 LEDs/Module	3 pcs
 Power per Module	0.72W
 Voltage	DC : 12V
 Flux per watt	85lm/W
 Beam Angle	120°
 IP Rating	IP65
 Dimension	70x16x8 mm

SKU No. **MO4536**



**LENS LED MODULE 0.72W**  
3x5050 SMD - Waterproof



Lumens



IP65

**ALUMINIUM PROFILES FOR LED STRIPS**



 **SKU No.** OT5190 6mm - (L=1m)  
OT5191 6mm - (L=2m)

OT5193 BUILT-IN 6mm - (L=1m)  
OT5192 BUILT-IN 6mm - (L=2m)

OT5194 Angle 18mm - (L=1m)  
OT5179 Angle 18mm - (L=2m)

OT5001 Bendable - (L=1m)  
OT5002 Bendable - (L=2m)



### Strip Power Supplies Premium

Plastic 12V ; 24V output

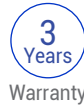

Warranty



DC:12V



IP20

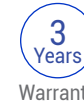

Warranty



DC:24V



IP20

- SKU No.
- Watts
- Input Voltage
- Output Voltage
- Current
- Material
- IP Rating
- Dimension

AC6201	AC6202	AC6203
36W	60W	72W
100-240V	100-240V	100-240V
DC:12V	DC:12V	DC:12V
3A	5A	6A
Plastic	Plastic	Plastic
IP20	IP20	IP20
119x52x32 mm	119x52x32 mm	119x52x32 mm

AC6206	AC6207	AC6208
36W	60W	72W
100-240V	100-240V	100-240V
DC:24V	DC:24V	DC:24V
1.5A	2.5A	3A
Plastic	Plastic	Plastic
IP20	IP20	IP20
119x52x32 mm	119x52x32 mm	119x52x32 mm

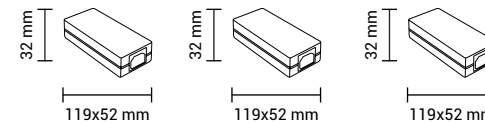
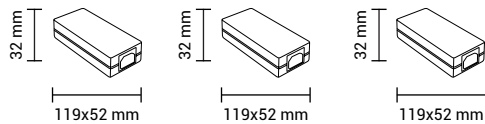



## Strip Power Supplies Premium

SLIM - Metal 12V ; 24V output



Warranty



DC:12V



IP20

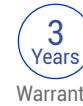

Warranty



DC:24V



IP20

SKU No.	AC6211	AC6212	AC6213	AC6214	AC6221	AC6222	AC6223	AC6224
Watts	60W	100W	150W	200W	60W	100W	150W	200W
Input Voltage	100-240V	100-240V	176-265V	176-265V	100-240V	100-240V	176-265V	176-265V
Output Voltage	DC:12V	DC:12V	DC:12V	DC:12V	DC:24V	DC:24V	DC:24V	DC:24V
Current	5A	8.4A	12.5A	16.7A	2.5A	4.2A	6.25A	8.35A
Material	Metal	Metal	Metal	Metal	Metal	Metal	Metal	Metal
IP Rating	IP20	IP20	IP20	IP20	IP20	IP20	IP20	IP20
Dimension	130x50x31 mm	190x50x31 mm	200x62x31 mm	208x82x32 mm	130x50x31 mm	190x50x31 mm	200x60x31 mm	208x82x32 mm

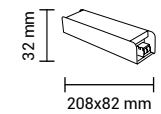
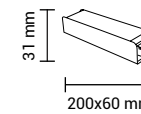
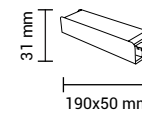
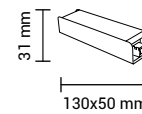
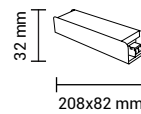
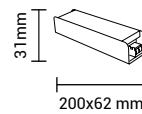
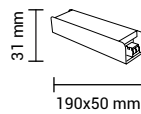
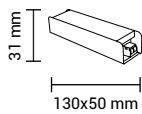



### Strip Power Supplies Premium

Plastic Case 12V ; 24V output



Warranty



DC:12V



IP20



Warranty



DC:24V



IP20

SKU No.

Watts

Input Voltage

Output Voltage

Current

Material

IP Rating

Dimension

AC6231	AC6232	AC6233
24W	36W	60W
100-240V	100-240V	100-240V
DC:12V	DC:12V	DC:12V
2A	3A	5A
Plastic	Plastic	Plastic
IP20	IP20	IP20
120x42x28 mm	140x48x30 mm	155x53x30 mm

AC6241	AC6242	AC6243
24W	36W	60W
100-240V	100-240V	100-240V
DC:24V	DC:24V	DC:24V
1A	1.5A	2.5A
Plastic	Plastic	Plastic
IP20	IP20	IP20
120x42x28 mm	140x48x30 mm	155x53x30 mm

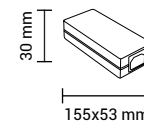
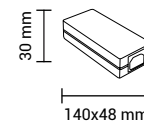
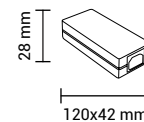
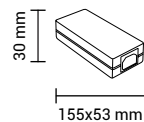
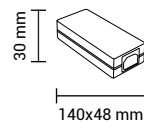
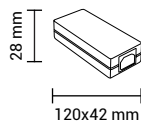



## Strip Power Supplies Premium

Waterproof Metal 12V ; 24V output



Warranty



DC:12V



IP67



Warranty



DC:24V



IP67

<b>SKU No.</b>	AC6251	AC6252	AC6253	AC6254
<b>Watts</b>	60W	100W	150W	200W
<b>Input Voltage</b>	100-240V	100-240V	176-265V	176-265V
<b>Output Voltage</b>	DC:12V	DC:12V	DC:12V	DC:12V
<b>Current</b>	5A	8.4A	12.5A	16.7A
<b>Material</b>	Metal	Metal	Metal	Metal
<b>IP Rating</b>	IP67	IP67	IP67	IP67
<b>Dimension</b>	158x52x32 mm	220x52x32 mm	230x65x32 mm	244x80x32 mm

AC6261	AC6262	AC6263	AC6264
60W	100W	150W	200W
100-240V	100-240V	176-265V	176-265V
DC:24V	DC:24V	DC:24V	DC:24V
2.5A	4.2A	6.25A	8.35A
Metal	Metal	Metal	Metal
IP67	IP67	IP67	IP67
158x52x32 mm	220x52x32 mm	230x65x32 mm	244x80x32 mm

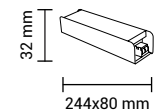
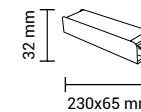
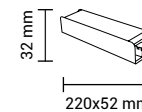
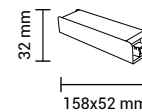
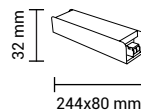
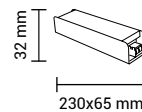
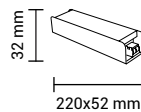
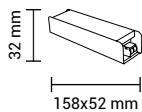



## Strip Power Supplies

Plastic 12V output

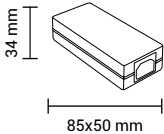
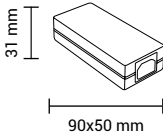
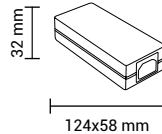
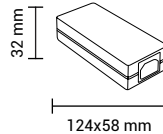
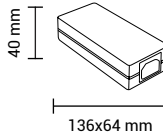

SKU No.	AC6120	AC6101	AC6102	AC6103	AC6119
Watts	18W	24W	36W	60W	80W
Input Voltage	220V	220V	220V	220V	220V
Output Voltage	DC:12V	DC:12V	DC:12V	DC:12V	DC:12V
Current	1.5A	2A	3A	5A	6.5A
Material	Plastic	Plastic	Plastic	Plastic	Plastic
IP Rating	IP20	IP20	IP20	IP20	IP20
Dimension	85x50x34 mm 	90x50x31 mm 	124x58x32 mm 	124x58x32 mm 	136x64x40 mm 





**Strip Power Supplies**  
Waterproof Metal 12V output



DC:12V

IP65

SKU No.	AC6110	AC6111	AC6115	AC6112
Watts	30W	60W	100W	150W
Input Voltage	220V	220V	220V	220V
Output Voltage	DC:12V	DC:12V	DC:12V	DC:12V
Current	2.5A	5A	8.5A	12.5A
Material	Aluminium	Aluminium	Aluminium	Aluminium
IP Rating	IP65	IP65	IP65	IP65
Dimension	221x30x34 mm	174x67x43 mm	237x70x43 mm	235x50x85 mm

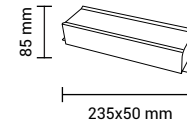
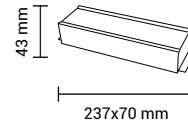
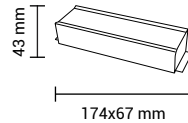
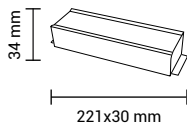

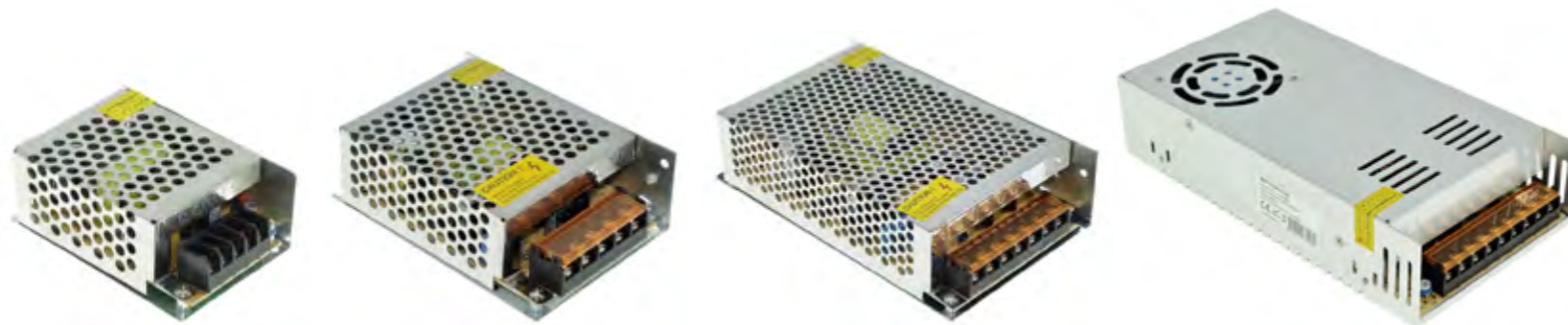

### Strip Power Supplies

Metal 12V output



SKU No.	AC6104	AC6121	AC6105	AC6109	AC6106	AC6114	AC6117	AC6108	AC6124
Watts	24W	36W	60W	100W	120W	150W	250W	360W	500W
Input Voltage	220V	220V	220V	220V	220V	220V	220V	220V	220V
Output Voltage	DC:12V	DC:12V	DC:12V	DC:12V	DC:12V	DC:12V	DC:12V	DC:12V	DC:12V
Current	2A	3A	5A	8.3A	10A	12.5A	20A	30A	41.5A
Material	Metal	Metal	Metal	Metal	Metal	Metal	Metal	Metal with Fan	Metal with Fan
IP Rating	IP20	IP20	IP20	IP20	IP20	IP20	IP20	IP20	IP20
Dimension	85x57x34 mm	85x57x34 mm	115x80x50 mm	165x105x50 mm	165x100x65 mm	205x100x50 mm	200x115x55 mm	220x115x55 mm	220x115x55 mm

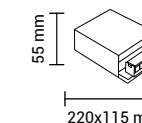
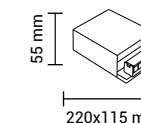
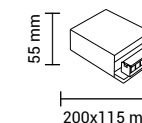
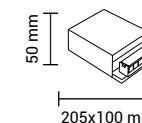
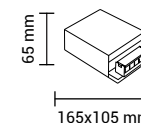
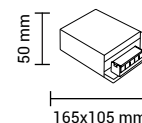
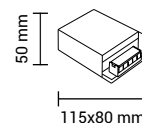
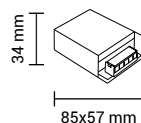
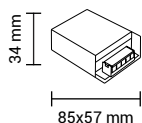



## Strip Power Supplies

Metal 24V output



DC:24V



IP20

SKU No.	AC6154	AC6151	AC6155	AC6152	AC6153
Watts	60W	100W	150W	250W	360W
Input Voltage	220V	220V	220V	220V	220V
Output Voltage	DC:24V	DC:24V	DC:24V	DC:24V	DC:24V
Current	2.5A	4.2A	6.25A	10.5A	15A
Material	Metal	Metal	Metal	Metal	Metal with Fan
IP Rating	IP20	IP20	IP20	IP20	IP20
Dimension	165x100x45 mm	210x100x45 mm	205x105x50 mm	200x110x50 mm	220x115x55 mm



### Strip Power Supplies

SLIM - Metal 12V output



SLIM LINE



DC:12V



IP20

SKU No.	AC6131	AC6132	AC6133	AC6134	AC6135
Watts	60W	100W	150W	250W	360W
Input Voltage	220V	220V	220V	220V	220V
Output Voltage	DC:12V	DC:12V	DC:12V	DC:12V	DC:12V
Current	5A	8.5A	12.5A	20A	30A
Material	Metal	Metal	Metal	Metal with Fan	Metal with Fan
IP Rating	IP20	IP20	IP20	IP20	IP20
Dimension	170x45x38 mm	190x48x38 mm	207x63x49 mm	230x75x45 mm	230x75x45 mm

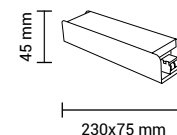
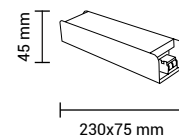
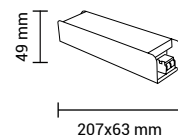
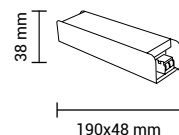
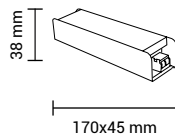



## Strip Power Supplies

SLIM - Metal 24V output











SLIM LINE



DC:24V





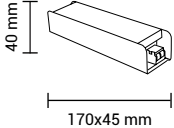
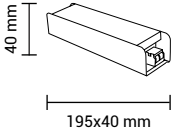
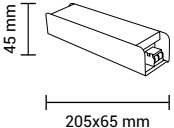
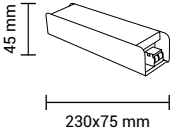
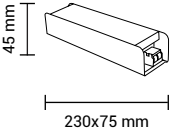

IP20

 SKU No.	AC6161	AC6162	AC6163	AC6164	AC6165
 Watts	60W	100W	150W	250W	360W
 Input Voltage	220V	220V	220V	220V	220V
 Output Voltage	DC:24V	DC:24V	DC:24V	DC:24V	DC:24V
 Current	2.5A	4.2A	6.25A	10.5A	15A
 Material	Metal	Metal	Metal	Metal with Fan	Metal with Fan
 IP Rating	IP20	IP20	IP20	IP20	IP20
 Dimension	170x45x40 mm	195x40x40 mm	205x65x45 mm	230x75x45 mm	230x75x45 mm
					

**DIMMER LED STRIP**

WITH REMOTE CONTROL 8A







 SKU No.	AC6302
 Power	96W-192W
 Voltage	12V-24V
 IP Rating	IP20
 Dimension	80x55x30mm

**REMOTE CONTROL LED STRIP**

RGB - 16 BUTTONS 3x2A







 SKU No.	AC6303
 Power	72W
 Voltage	12V
 IP Rating	IP20
 Dimension	50x35x20mm

**REMOTE CONTROL LED STRIP**

RGB - 4 BUTTONS 3x4A







 SKU No.	AC6304
 Power	144W-288W
 Voltage	12V-24V
 IP Rating	IP20
 Dimension	105x65x20mm

**REMOTE CONTROL LED STRIP**

RGB - 44 BUTTONS







 SKU No.	AC6306 / AC6307
 Power	72W / 144W
 Voltage	12V
 IP Rating	IP20
 Dimension	50x35x20mm

**WIFI CONTROLLER**

RGB / SINGLE COLOR 3x4A







 <b>SKU No.</b>	AC6310	AC6311
 <b>Power</b>	90-288W	90-288W
 <b>Voltage</b>	7.5-24V	7.5-24V
 <b>IP Rating</b>	IP20	IP20
 <b>Dimension</b>	80x55x30mm	80x55x30mm

**AMPLIFIER FOR LED STRIP**

RGB+WHITE 4x6A







 <b>SKU No.</b>	AC6328
 <b>Power</b>	288W-576W
 <b>Voltage</b>	12V-24V
 <b>IP Rating</b>	IP20
 <b>Dimension</b>	65x55x20mm

**AMPLIFIER FOR LED STRIP**

RGB - IRON SHELL 3x8A







 <b>SKU No.</b>	AC6326
 <b>Power</b>	288W-576W
 <b>Voltage</b>	12V-24V
 <b>IP Rating</b>	IP20
 <b>Dimension</b>	80x70x30mm

**AMPLIFIER FOR LED STRIP**

RGB 3x4A







 <b>SKU No.</b>	AC6305
 <b>Watts</b>	144W-288W
 <b>Voltage</b>	12V-24V
 <b>IP Rating</b>	IP20
 <b>Dimension</b>	80x55x20mm







**REMOTE CONTROL LED STRIP**

RGB TOUCH MINI WHITE/BLACK 3x6A

 SKU No.	AC6314	AC6315
 Power	216W-432W	216W-432W
 Voltage	12V-24V	12V-24V
 IP Rating	IP20	IP20
 Dimension	95x50x30mm	95x50x30mm





**REMOTE CONTROL LED STRIP**

RGBW TOUCH 4x6A

 SKU No.	AC6329
 Power	288W-576W
 Voltage	12V-24V
 IP Rating	IP20
 Dimension	80x45x15mm





**MUSIC LED CONTROLLER**

WITH REMOTE CONTROL 3x4A

 SKU No.	AC6312
 Power	144W-288W
 Voltage	12V-24V
 IP Rating	IP20
 Dimension	170x85x23mm

**DMX512 DECODER**

3x4A

 SKU No.	AC6308
 Power	144W-288W
 Voltage	12V-24V
 IP Rating	IP20
 Dimension	160x60x42mm



**SENSOR DIMMER**

WALL MOUNTED 10A



- SKU No. AC6318
- Power 120W-240W
- Voltage 12V-24V
- IP Rating IP20
- Dimension 85x85x40mm

**SENSOR DIMMER**

WALL MOUNTED 10A



- SKU No. AC6320
- Power 120W-240W
- Voltage 12V-24V
- IP Rating IP20
- Dimension 85x85x40mm

**SENSOR DIMMER**

WALL MOUNTED WHITE 3x4A



- SKU No. AC6319
- Power 144W-288W
- Voltage 12V-24V
- IP Rating IP20
- Dimension 85x85x40mm

**SENSOR DIMMER**

WALL MOUNTED BLACK 3x4A



- SKU No. AC6317
- Power 144W-288W
- Voltage 12V-24V
- IP Rating IP20
- Dimension 85x85x40mm

**SINGLE COLOR DIMMING REMOTE CONTROL SET**

RF 2.4G 3CH 3x4A V3



	SKU No.	AC6348
	Power	144W-288W
	Voltage	12V-24V
	IP Rating	IP20

**RGB DIMMING REMOTE CONTROL SET**

RF 2.4G 3CH 3x4A V3



	SKU No.	AC6349
	Power	144W-288W
	Voltage	12V-24V
	IP Rating	IP20

**USB Chargeable LED Touch Panel Remote Control**

Single Color - 2.4GHz

Buid-in rechargeable battery.  
USB recrgearable, stand by time: 6 months.



	SKU No.	AC6351
	Power	-
	Voltage	5V
	IP Rating	IP20
	Dimension	86x86x13.5mm

**USB Chargeable LED Touch Panel Remote Control**

RGB / RGBW - 2.4GHz

Buid-in rechargeable battery.  
USB recrgearable, stand by time: 6 months.







	SKU No.	AC6352
	Power	-
	Voltage	5V
	IP Rating	IP20
	Dimension	86x86x13.5mm

### WIFI-RELAY 2.4GHz

WiFi to RF Converter



-  **SKU No.** AC6354
-  **Distance** 30m
-  **Voltage** DC 5-24V
-  **IP Rating** IP20
-  **Dimension** ø72x25mm







SkySmart App  
ANDROID / iOS

### RGB/RGBW CONTROLLER 3 CHANNEL

RF 2.4G 3CH 3x4A V3







-  **SKU No.** AC6353
-  **Power** 144W-288W
-  **Voltage** DC 12-24V
-  **IP Rating** IP20
-  **Dimension** 96x33x17mm

### RGB/RGBW CONTROLLER 4 CHANNEL

4CH 4x5A V4 CONSTANT VOLTAGE







-  **SKU No.** AC6342
-  **Power** 4x(60-180)W
-  **Voltage** 12V-36VDC
-  **IP Rating** IP20
-  **Dimension** 175x45x27mm

### RGB/RGBW CONTROLLER 4 CHANNEL

4CH 4x300mA C4 CONSTANT CURRENT





-  **SKU No.** AC6343
-  **Power** 4x(3.6-14.4)W
-  **Voltage** 12V-48VDC
-  **IP Rating** IP20
-  **Dimension** 170x85x23mm

**LED RGB/RGBW Remote**

4 ZONES RF



-  **SKU No.** AC6345
-  **IP Rating** IP20
-  **Dimension** 122x53x18mm

Wall mounted holder for AC6341





-  **SKU No.** AC6347
- Dimension** 58x54x22mm

**LED RGB/RGBW Remote**

4 ZONES RF



-  **SKU No.** AC6344
-  **IP Rating** IP20
-  **Dimension** 107x58x10mm

**RF LED Remote**

4 ZONES SINGLE,CCT COLOR



- |  | Single Color | CCT         |
|--|--------------|-------------|
|  <b>SKU No.</b>   | AC6141       | AC6140      |
|  <b>IP Rating</b> | IP20         | IP20        |
|  <b>Dimension</b> | 135x40x11mm  | 135x40x11mm |

Wall mounted holder for AC6341





-  **SKU No.** AC6346
- Dimension** 70x45x18mm

**LED CCT Remote**

4 Zones RF 2.4G



-  **SKU No.** AC6350
-  **IP Rating** IP20
-  **Dimension** 175x51x32mm

**ACCESSORIES FOR LED STRIPS**



CONNECTOR FOR STRIP 3528

**SKU No.** OT5151



ANGLE CONNECTOR FOR STRIP 3528 8mm

**SKU No.** AC6619



CONNECTOR FOR STRIP DC MALE

**SKU No.** AC6610



FLEXIBLE FOR STRIP 5050 DC FEMALE

**SKU No.** AC6613



FLEXIBLE CONNECTOR FOR LED STRIP 5050

**SKU No.** AC6616



CONNECTOR FOR STRIP 5050

**SKU No.** OT5152



ANGLE CONNECTOR FOR STRIP 5050 10mm

**SKU No.** AC6620



CONNECTOR FOR STRIP DC FEMALE

**SKU No.** AC6611



FLEXIBLE CONNECTOR FOR LED STRIP RGB

**SKU No.** AC6614



FLEXIBLE CONNECTOR FOR STRIP RGB+WH

**SKU No.** AC6618



CONNECTOR FOR STRIP RGB

**SKU No.** AC6608



ANGLE CONNECTOR FOR STRIP RGB 10mm

**SKU No.** AC6621



FLEXIBLE FOR STRIP 3528 DC FEMALE

**SKU No.** AC6612



FLEXIBLE CONNECTOR FOR LED STRIP 3528

**SKU No.** AC6615



FLEXIBLE FOR RGB LED STRIP WITH PIN

**SKU No.** AC6617

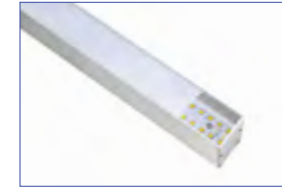
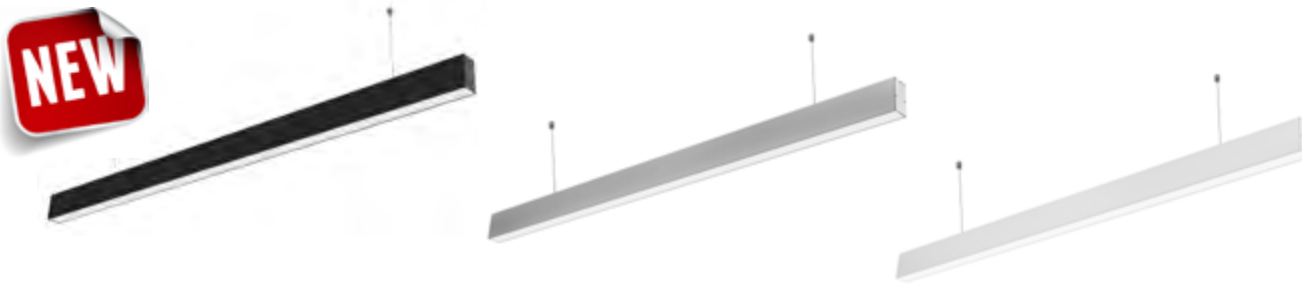

## LED LINEAR SUSPENDED LIGHTS

SLIM

**40W** **3400** **BLACK**  
Lumens

**40W** **3400** **SILVER**  
Lumens

**40W** **3400** **WHITE**  
Lumens

- SKU No.**
- Light Color**
- Watts**
- Input Voltage**
- Flux**
- Beam Angle**
- CRI**
- IP Rating**
- Dimension**

LN5372/LN5371
6000K/4000K
40W
AC : 200-240V
3400lm
120°
Ra>80
IP20
1200x35x67 mm

LN5374/LN5373
6000K/4000K
40W
AC : 200-240V
3400lm
120°
Ra>80
IP20
1200x35x67 mm

LN5376/LN5375
6000K/4000K
40W
AC : 200-240V
3400lm
120°
Ra>80
IP20
1200x35x67 mm

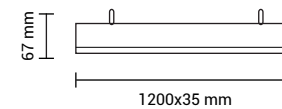
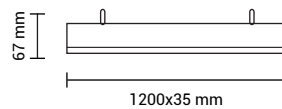
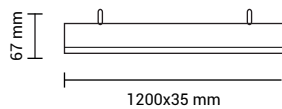
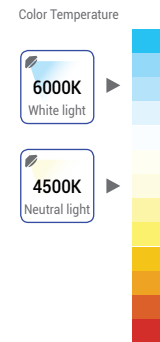



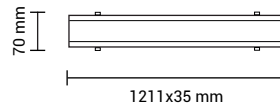

SKU No.	LN5377
Light Color	4000K
Watts	40W
Input Voltage	AC : 200-240V
Flux	3400lm
Beam Angle	120°
CRI	Ra>80
IP Rating	IP20
Dimension	1211x70x35 mm

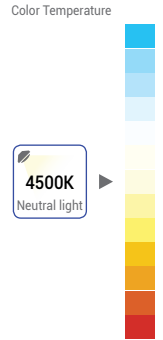

**LED LINEAR RECESSED LIGHTS**  
LINKABLE WITH CONNECTORS



L-SHAPE CONNECTOR



L-SHAPE CONNECTOR



L-SHAPE CONNECTOR



T-SHAPE CONNECTOR



X-SHAPE CONNECTOR

SKU No.	OT5031	OT5032	OT5033	OT5034	OT5035
Light Color	4000K	4000K	4000K	4000K	4000K
Watts	8W	8W	8W	12W	16W
Input Voltage	AC : 200-240V	AC : 200-240V	AC : 200-240V	AC : 200-240V	AC : 200-240V
Dimension	136x136x35 mm	134x134x35 mm	181x181x35 mm	255x127x35 mm	255x255x35 mm

**CONNECTORS FOR LED LINEAR RECESSED LIGHTS**





**CREE** LED CHIPS

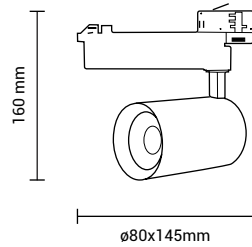

**25W COB Track Light**  
For 3-Phase 4-Line Tracks

SKU No.	FL5321/FL5322/FL5323
Light Color	5000K/4500K/3000K
Watts	25W
Input Voltage	AC : 200-240V
Flux	2750lm
Beam Angle	24°
CRI	Ra>80
IP Rating	IP20
Dimension	ø80x145x160 mm

Color Temperature

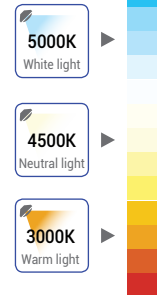

3 Years Warranty    2750 Lumens    24° Beam Angle    IP20 Protection



**CREE** LED CHIPS

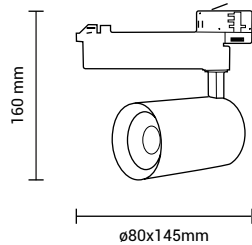

**25W COB Track Light**  
For 3-Phase 4-Line Tracks

SKU No.	FL5327/FL5328/FL5329
Light Color	5000K/4500K/3000K
Watts	25W
Input Voltage	AC : 200-240V
Flux	2750lm
Beam Angle	24°
CRI	Ra>80
IP Rating	IP20
Dimension	ø80x145x160 mm

Color Temperature

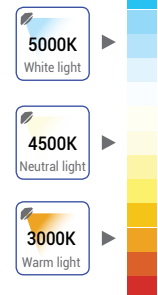

3 Years Warranty    2750 Lumens    24° Beam Angle    IP20 Protection





**35W COB Track Light**  
For 3-Phase 4-Line Tracks

**CREE** LED CHIPS

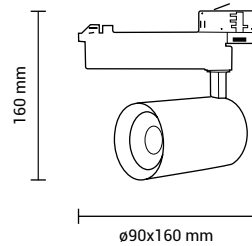

SKU No.	FL5324/FL5325/FL5326
Light Color	5000K/4500K/3000K
Watts	35W
Input Voltage	AC : 200-240V
Flux	3850lm
Beam Angle	24°
CRI	Ra>80
IP Rating	IP20
Dimension	ø90x160x160 mm

Color Temperature

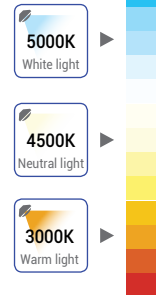

3 Years Warranty
3850 Lumens
24° Beam Angle
IP20 Protection



**35W COB Track Light**  
For 3-Phase 4-Line Tracks

**CREE** LED CHIPS

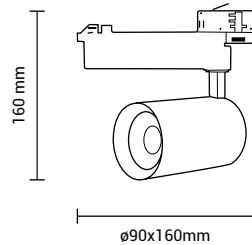

SKU No.	FL5330/FL5331/FL5332
Light Color	5000K/4500K/3000K
Watts	35W
Input Voltage	AC : 200-240V
Flux	3850lm
Beam Angle	24°
CRI	Ra>80
IP Rating	IP20
Dimension	ø90x160x160 mm

Color Temperature

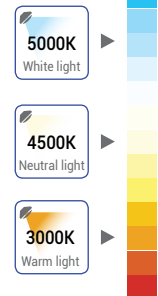

3 Years Warranty
3850 Lumens
24° Beam Angle
IP20 Protection

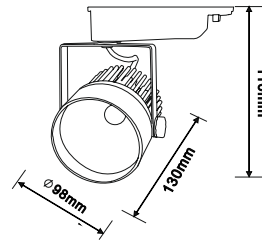

SKU No.	FL5149/FL5120/FL5126
Light Color	6000K/4500K/2700K
Watts	12W
Input Voltage	AC : 110-240V
Flux	960lm
Beam Angle	24°
CRI	Ra>80
IP Rating	IP20
Dimension	ø98x130x110 mm

Color Temperature

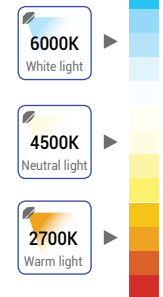

## 12W COB Track Light

Interior Floodlight

EPISTAR  
Chips960  
Lumens

24°



IP20

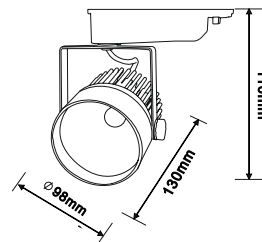

SKU No.	FL5127/FL5118/FL5117
Light Color	6000K/4500K/2800K
Watts	12W
Input Voltage	AC : 110-240V
Flux	960lm
Beam Angle	24°
CRI	Ra>80
IP Rating	IP20
Dimension	ø98x130x110 mm

Color Temperature

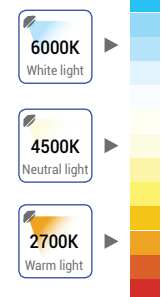

## 12W COB Track Light

Interior Floodlight

EPISTAR  
Chips960  
Lumens

24°



IP20



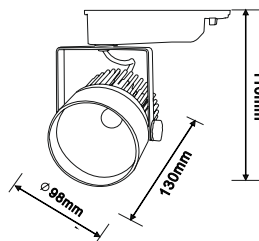

**25W COB Track Light**  
Interior Floodlight

SKU No.	FL5130/FL5128/FL5135
Light Color	6000K/4500K/2700K
Watts	25W
Input Voltage	AC : 110-240V
Flux	1650lm
Beam Angle	24°
CRI	Ra>80
IP Rating	IP20
Dimension	ø98x130x110 mm

Color Temperature

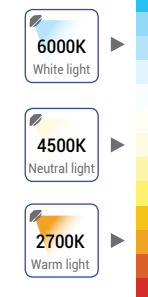

EPISTAR  
Chips



Lumens



24°



IP20

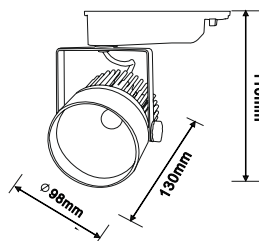

**25W COB Track Light**  
Interior Floodlight

SKU No.	FL5136/FL5137/FL5138
Light Color	6000K/4500K/2700K
Watts	25W
Input Voltage	AC : 110-240V
Flux	1650lm
Beam Angle	24°
CRI	Ra>80
IP Rating	IP20
Dimension	ø98x130x110 mm

Color Temperature

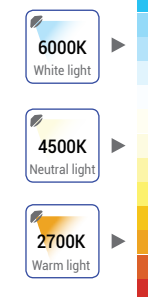

EPISTAR  
Chips



Lumens



24°



IP20





TRACK SYSTEM - 1M WHITE  
SKU No. OT5153



TRACK SYSTEM - 2M WHITE  
SKU No. OT5156



CONNECTOR LINE - WHITE  
SKU No. OT5157



CONNECTOR ANGLE - WHITE  
SKU No. OT5158



TRACK SYSTEM - 1M WHITE  
SKU No. OT5154



TRACK SYSTEM - 2M WHITE  
SKU No. OT5155



CONNECTOR LINE BLACK  
SKU No. OT5159



CONNECTOR ANGLE - BLACK  
SKU No. OT5160



## ACCESSORIES FOR 2-PHASE TRACK LIGHTS



TRACK SYSTEM 3PHASES - 1M WHITE  
SKU No. OT5007



STRAIGHT CONNECTOR WHITE  
SKU No. OT5013



MINI STRAIGHT CONNECTOR WHITE  
SKU No. OT5011



T-CONNECTOR WHITE  
SKU No. OT5017



END CAP WHITE  
SKU No. OT5023



TRACK SYSTEM 3PHASES - 1M BLACK  
SKU No. OT5008



STRAIGHT CONNECTOR BLACK  
SKU No. OT5014



MINI STRAIGHT CONNECTOR BLACK  
SKU No. OT5012



T-CONNECTOR BLACK  
SKU No. OT5018



END CAP BLACK  
SKU No. OT5024



TRACK SYSTEM 3PHASES - 2M WHITE  
SKU No. OT5009



L-FEEDER WHITE  
SKU No. OT5019



L-CONNECTOR WHITE  
SKU No. OT5015



X-CONNECTOR WHITE  
SKU No. OT5021



FLEXIBLE CONNECTOR WHITE  
SKU No. OT5025



TRACK SYSTEM 3PHASES - 2M BLACK  
SKU No. OT5010



L-FEEDER BLACK  
SKU No. OT5020



L-CONNECTOR BLACK  
SKU No. OT5016



X-CONNECTOR BLACK  
SKU No. OT5022



FLEXIBLE CONNECTOR BLACK  
SKU No. OT5026

**ACCESSORIES FOR 3-PHASE TRACK LIGHTS**





**LED FLOODLIGHTS**





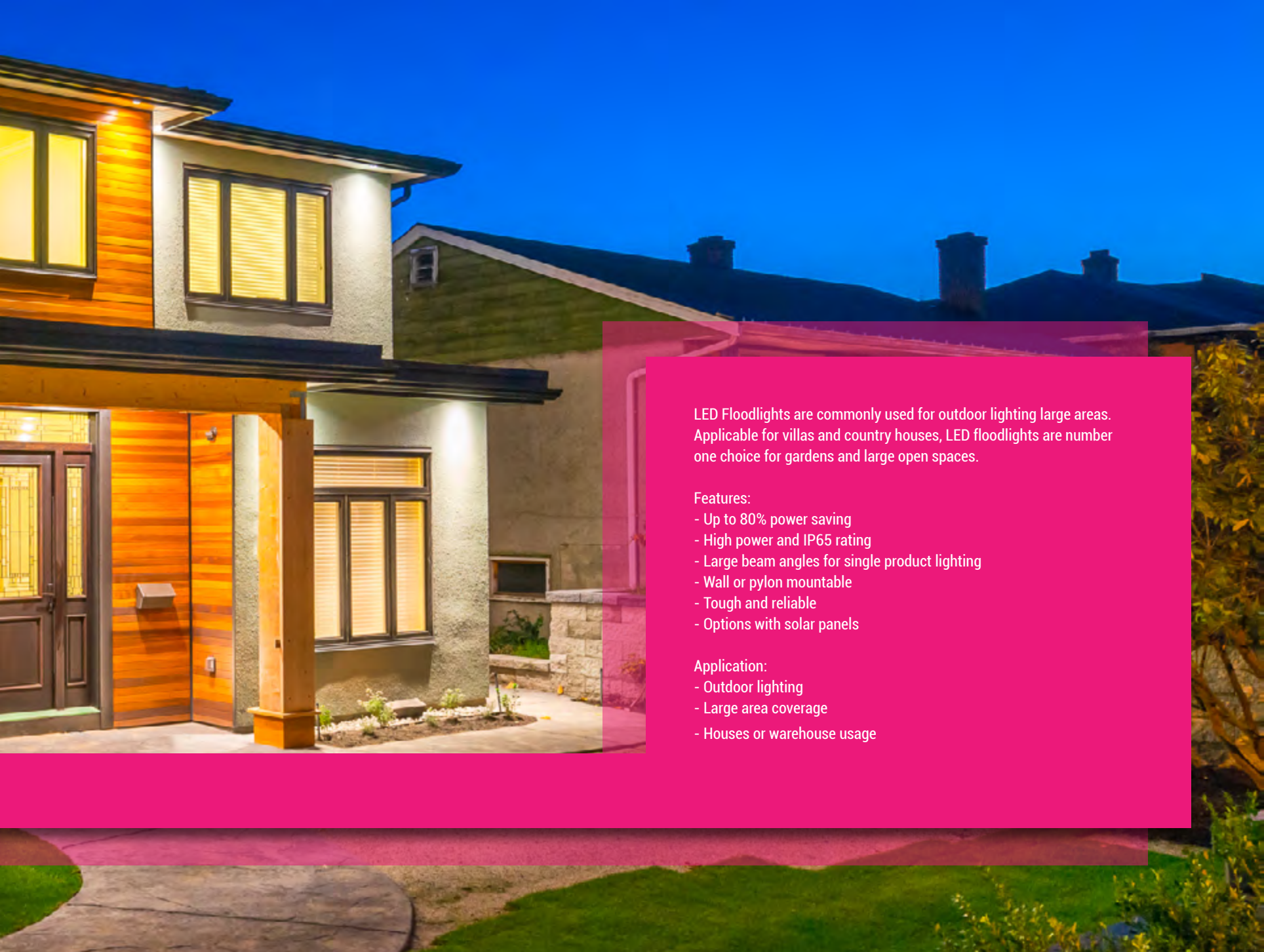

LED Floodlights are commonly used for outdoor lighting large areas. Applicable for villas and country houses, LED floodlights are number one choice for gardens and large open spaces.

**Features:**

- Up to 80% power saving
- High power and IP65 rating
- Large beam angles for single product lighting
- Wall or pylon mountable
- Tough and reliable
- Options with solar panels

**Application:**

- Outdoor lighting
- Large area coverage
- Houses or warehouse usage



Power Cable Length-1.00m



IP65



120°



3 Years Warranty

### LED SMD5730 FLOODLIGHT PF>0.9

Dual Voltage With Terminal Block

**50W** **4500**  
Lumens

**100W** **9000**  
Lumens

**200W** **18000**  
Lumens

**300W** **27000**  
Lumens

- SKU No.
- Light Color
- Watts
- Input Voltage
- Flux
- Beam Angle
- CRI
- IP Rating
- Dimension

FL5275/FL5276
6000K/3000K
50W
AC : 85-265V
4500lm
120°
Ra>80
IP65
245x275x55mm

FL5277/FL5278
6000K/3000K
100W
AC : 85-265V
9000lm
120°
Ra>80
IP65
300x345x60 mm

FL5279/FL5280
6000K/3000K
200W
AC : 85-265V
18000lm
120°
Ra>80
IP65
380x420x80 mm

FL5281
6000K
300W
AC : 85-265V
27000lm
120°
Ra>80
IP65
500x420x100

Color Temperature

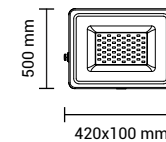
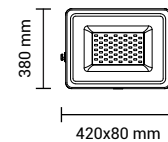
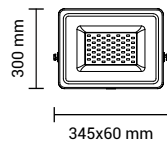
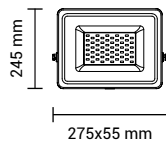
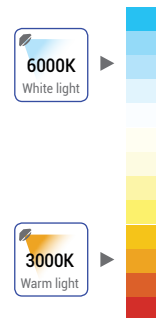

**NEW**

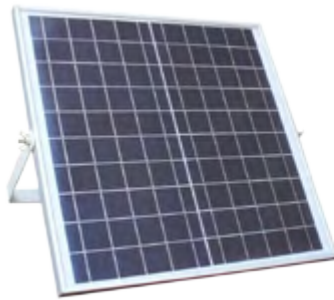

IP65



120°



Battery

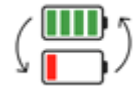

>1500 Times

## LED SMD FLOODLIGHT

With Solar Panels and Remote Control

**25W**



500  
Lumens

FL5460

6000K

25W

3.2V / 5.5Ah

500lm

120°

Ra>80

IP65

205x170x55 mm

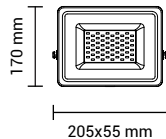

**40W**



800  
Lumens

FL5461

6000K

40W

3.2V / 11Ah

800lm

120°

Ra>80

IP65

245x210x65 mm

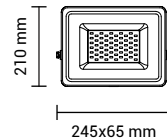

**60W**



12000  
Lumens

FL5462

6000K

60W

6.4V / 11Ah

1200lm

120°

Ra>80

IP65

275x235x65 mm

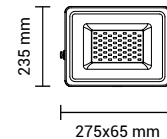

**100W**



2000  
Lumens

FL5463

6000K

100W

6.4V 16.5Ah

2000lm

120°

Ra>80

IP65

320x280x80mm

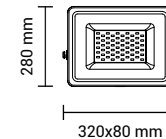

- SKU No.
- Light Color
- Watts
- Battery
- Flux
- Beam Angle
- CRI
- IP Rating
- Dimension

Color Temperature





Power Cable Length-0.70m

EPISTAR  
Chips



IP65



HIGH

Lumen



5 Years

Warranty

## LED SMD FLOODLIGHT PF>0.9

Premium Line - White Body

**10W** **850**  
Lumens

**20W** **1700**  
Lumens

**30W** **2500**  
Lumens

**50W** **4250**  
Lumens

**100W** **8500**  
Lumens

- SKU No.**
- Light Color**
- Watts**
- Input Voltage**
- Flux**
- Beam Angle**
- CRI**
- IP Rating**
- Dimension**

FL5865/FL5866/FL5867
6000K/4500K/2800K
10W
AC : 220-240V
850lm
150°
Ra>80
IP65
127x113x22 mm

FL5868/FL5869/FL5870
6000K/4500K/2800K
20W
AC : 220-240V
1700lm
150°
Ra>80
IP65
162x136x24mm

FL5871/FL5872/FL5873
6000K/4500K/2800K
30W
AC : 220-240V
2500lm
150°
Ra>80
IP65
192x157x25 mm

FL5874/FL5875/FL5876
6000K/4500K/2800K
50W
AC : 220-240V
4250lm
150°
Ra>80
IP65
227x185x26 mm

FL5877/FL5878/FL5879
6000K/4500K/2800K
100W
AC : 220-240V
8500lm
150°
Ra>80
IP65
316x245x33 mm

Color Temperature

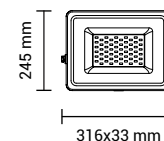
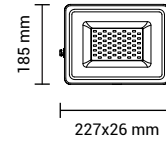
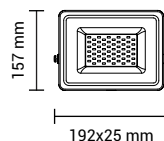
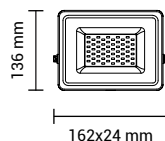
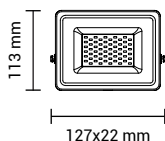
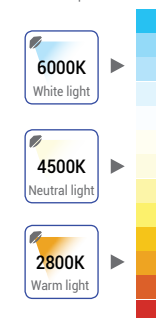



Power Cable Length-0.70m

EPISTAR  
Chips



IP65



HIGH  
Lumen



5  
Years  
Warranty

**LED SMD FLOODLIGHT PF>0.9**

Premium Line - Black Body

**10W** **850**  
Lumens

**20W** **1700**  
Lumens

**30W** **2500**  
Lumens

**50W** **4250**  
Lumens

**100W** **8500**  
Lumens

SKU No.	FL5880/FL5881/FL5882	FL5883/FL5884/FL5885	FL5886/FL5887/FL5888	FL5889/FL5890/FL5891	FL5892/FL5893/FL5894
Light Color	6000K/4500K/2800K	6000K/4500K/2800K	6000K/4500K/2800K	6000K/4500K/2800K	6000K/4500K/2800K
Watts	10W	20W	30W	50W	100W
Input Voltage	AC : 220-240V	AC : 220-240V	AC : 220-240V	AC : 220-240V	AC : 220-240V
Flux	850lm	1700lm	2500lm	4250lm	8500lm
Beam Angle	150°	150°	150°	150°	150°
CRI	Ra>80	Ra>80	Ra>80	Ra>80	Ra>80
IP Rating	IP65	IP65	IP65	IP65	IP65
Dimension	127x113x22 mm	162x136x24mm	192x157x25 mm	227x185x26 mm	316x245x33 mm

Color Temperature

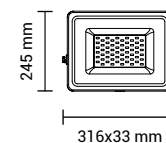
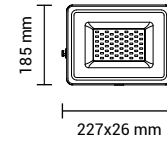
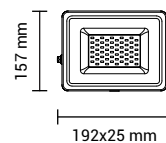
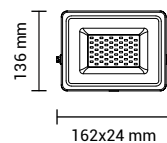
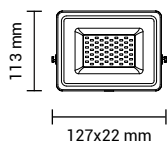
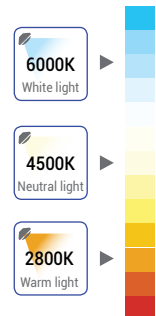





Power Cable Length-1.00m

EPISTAR Chips



IP65



HIGH Lumen



5 Years Warranty

**LED SMD FLOODLIGHT PF>0.9**

Premium Line - White Body

**150W** **18000**  
Lumens

**200W** **24000**  
Lumens

**300W** **36000**  
Lumens

- SKU No.
- Light Color
- Watts
- Input Voltage
- Flux
- Beam Angle
- CRI
- IP Rating
- Dimension

FL5786/FL5787
6000K/4500K
150W
AC : 100-240V
18 000lm
150°
Ra>80
IP65
367x305x51 mm

FL5788/FL5789
6000K/4500K
200W
AC : 100-240V
24 000lm
150°
Ra>80
IP65
408x337x53 mm

FL5790/FL5791
6000K/4500K
300W
AC : 100-240V
36 000lm
150°
Ra>80
IP65
540x400x50 mm

Color Temperature

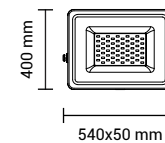
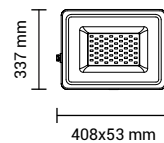
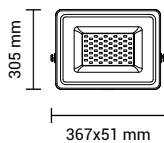
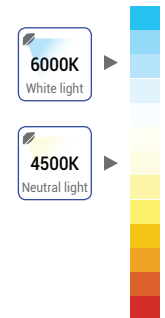





Power Cable Length-1.00m

EPISTAR  
Chips



IP65



HIGH  
Lumen



5  
Years  
Warranty

**LED SMD FLOODLIGHT PF>0.9**

Premium Line - Black Body

**150W** **18000**  
Lumens

**200W** **24000**  
Lumens

**300W** **36000**  
Lumens

- SKU No.
- Light Color
- Watts
- Input Voltage
- Flux
- Beam Angle
- CRI
- IP Rating
- Dimension

SKU No.	FL5792/FL5793
Light Color	6000K/4500K
Watts	150W
Input Voltage	AC : 100-240V
Flux	18 000lm
Beam Angle	150°
CRI	Ra>80
IP Rating	IP65
Dimension	367x305x51 mm

SKU No.	FL5794/FL5795
Light Color	6000K/4500K
Watts	200W
Input Voltage	AC : 100-240V
Flux	24 000lm
Beam Angle	150°
CRI	Ra>80
IP Rating	IP65
Dimension	408x337x53 mm

SKU No.	FL5796/FL5797
Light Color	6000K/4500K
Watts	300W
Input Voltage	AC : 100-240V
Flux	36 000lm
Beam Angle	150°
CRI	Ra>80
IP Rating	IP65
Dimension	540x400x50 mm

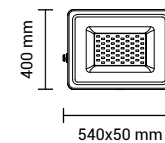
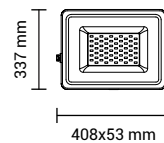
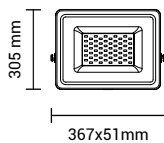

Color Temperature

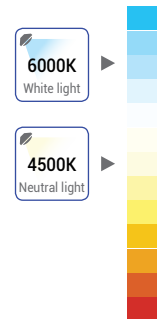



### LED SMD FLOODLIGHT

High Power

**100W** **8000**  
Lumens

**150W** **12000**  
Lumens

**200W** **16000**  
Lumens

**300W** **24000**  
Lumens

**400W** **32000**  
Lumens

- SKU No.**
- Light Color**
- Watts**
- Input Voltage**
- Flux**
- Beam Angle**
- CRI**
- IP Rating**
- Dimension**

FL5443/FL5429
6000K/4500K
100W
AC : 95-265V
8 000lm
120°
Ra>80
IP66
335x300x70 mm

FL5446/FL5445
6000K/4500K
150W
AC : 95-265V
12 000lm
120°
Ra>80
IP66
385x300x160mm

FL5449/FL5430
6000K/4500K
200W
AC : 95-265V
16 000lm
120°
Ra>80
IP66
423x320x150 mm

FL5447
6000K
300W
AC : 95-265V
24 000lm
120°
Ra>80
IP66
597x327x188 mm

FL5448
6000K
400W
AC : 95-265V
32 000lm
120°
Ra>80
IP66
670x325x190 mm

Color Temperature

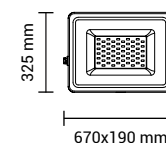
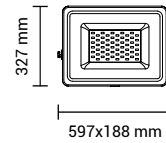
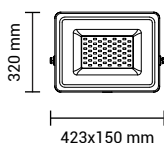
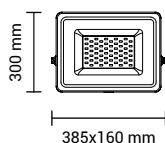
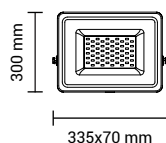
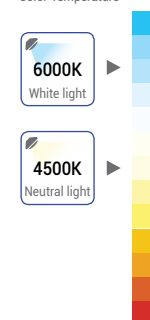



## LED RGB FLOODLIGHT

With Remote Control

**10W** **800**  
Lumens

**30W** **2400**  
Lumens

**50W** **4000**  
Lumens

- SKU No.
- Light Color
- Watts
- Input Voltage
- Flux
- Beam Angle
- CRI
- IP Rating
- Dimension

FL5210
RGB
10W
AC : 200-240V
800lm
120°
Ra>80
IP66
120x120x35 mm

FL5212
RGB
30W
AC : 200-240V
2400lm
120°
Ra>80
IP66
224x183x110 mm

FL5233
RGB
50W
AC : 200-240V
4000lm
120°
Ra>80
IP66
284x233x132 mm

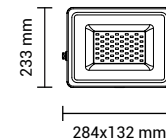
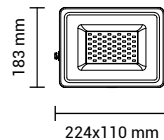
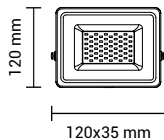



### LED SMD FLOODLIGHT

With PIR Sensor - Classic Line 2

White

10W



Lumens

20W



Lumens

30W











Lumens

50W



Lumens

-  **SKU No.**
-  **Light Color**
-  **Watts**
-  **Input Voltage**
-  **Flux**
-  **Beam Angle**
-  **CRI**
-  **IP Rating**
-  **Dimension**

FL5841/FL5842/FL5843	FL5844/FL5845/FL5846	FL5847/FL5848/FL5849	FL5850/FL5851
6000K/4500K/2700K	6000K/4500K/2700K	6000K/4500K/2700K	6000K/4500K/2700K
10W	20W	30W	50W
AC : 170-265V	AC : 170-265V	AC : 170-265V	AC : 170-265V
850lm	1700lm	2550lm	4500lm
100°	100°	100°	100°
Ra>80	Ra>80	Ra>80	Ra>80
IP65	IP65	IP65	IP65
135x113x30 mm	168x150x30mm	180x178x35 mm	203x214x35 mm

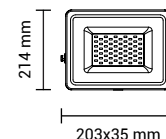
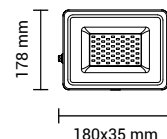
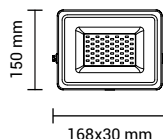
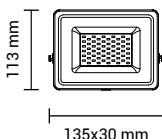

Color Temperature

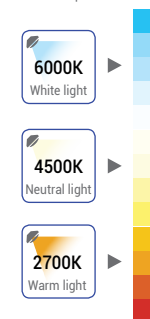



IP65



100°



SENSOR

**LED SMD FLOODLIGHT**

With PIR Sensor - Classic Line 2

Black

**10W**



Lumens

**20W**



Lumens

**30W**











Lumens

**50W**



Lumens

-  **SKU No.**
-  **Light Color**
-  **Watts**
-  **Input Voltage**
-  **Flux**
-  **Beam Angle**
-  **CRI**
-  **IP Rating**
-  **Dimension**

FL5853/FL5854/FL5855	FL5856/FL5857/FL5858	FL5859/FL5860/FL5861	FL5862/FL5863
6000K/4500K/2700K	6000K/4500K/2700K	6000K/4500K/2700K	6000K/4500K
10W	20W	30W	50W
AC : 170-265V	AC : 170-265V	AC : 170-265V	AC : 170-265V
850lm	1700lm	2550lm	4500lm
100°	100°	100°	100°
Ra>80	Ra>80	Ra>80	Ra>80
IP65	IP65	IP65	IP65
135x113x30 mm	168x150x30mm	180x178x35 mm	203x214x35 mm

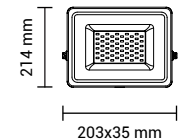
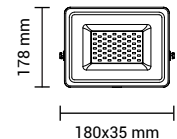
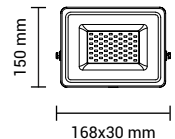
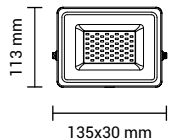

Color Temperature

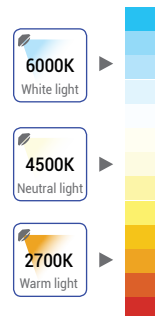



### LED SMD FLOODLIGHT

Classic Line 2 White







**10W**   
Lumens

**20W**   
Lumens

**30W**   
Lumens

**50W**   
Lumens

**100W**   
Lumens

 <b>SKU No.</b>	FL5801/FL5802/FL5803	FL5804/FL5805/FL5806	FL5807/FL5808/FL5809	FL5810/FL5811/FL5812	FL5816/FL5817
 <b>Light Color</b>	6000K/4500K/2700K	6000K/4500K/2700K	6000K/4500K/2700K	6000K/4500K/2700K	6000K/4500K
 <b>Watts</b>	10W	20W	30W	50W	100W
 <b>Input Voltage</b>	AC : 170-265V	AC : 170-265V	AC : 170-265V	AC : 170-265V	AC : 170-265V
 <b>Flux</b>	850lm	1700lm	2500lm	4250lm	8500lm
 <b>Beam Angle</b>	100°	100°	100°	100°	100°
 <b>CRI</b>	Ra>80	Ra>80	Ra>80	Ra>80	Ra>80
 <b>IP Rating</b>	IP65	IP65	IP65	IP65	IP65
 <b>Dimension</b>	115x112x27 mm	150x145x27mm	180x172x32 mm	215x160x35 mm	310x230x40 mm

Color Temperature

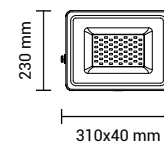
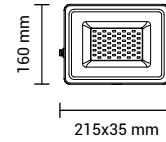
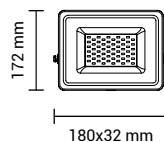
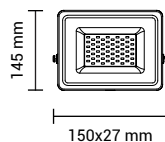
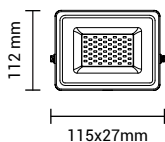
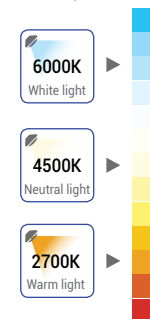



**LED SMD FLOODLIGHT**

Classic Line 2 Black

<b>10W</b>		<b>20W</b>		<b>30W</b>		<b>50W</b>		<b>70W</b>		<b>100W</b>	
	Lumens		Lumens		Lumens		Lumens		Lumens		Lumens

<b>SKU No.</b>	FL5821/FL5822/FL5823	FL5824/FL5825/FL5826	FL5827/FL5828/FL5829	FL5830/FL5831/FL5832	FL5833	FL5836/FL5837
<b>Light Color</b>	6000K/4500K/2700K	6000K/4500K/2700K	6000K/4500K/2700K	6000K/4500K/2700K	6000K	6000K/4500K
<b>Watts</b>	10W	20W	30W	50W	70W	100W
<b>Input Voltage</b>	AC : 170-265V	AC : 170-265V	AC : 170-265V	AC : 170-265V	AC : 170-265V	AC : 170-265V
<b>Flux</b>	850lm	1700lm	2550lm	4250lm	5950lm	8500lm
<b>Beam Angle</b>	100°	100°	100°	100°	100°	100°
<b>CRI</b>	Ra>80	Ra>80	Ra>80	Ra>80	Ra>80	Ra>80
<b>IP Rating</b>	IP65	IP65	IP65	IP65	IP65	IP65
<b>Dimension</b>	115x90x27 mm	150x110x27 mm	180x130x32 mm	215x160x35 mm	250x190x37 mm	310x230x40 mm

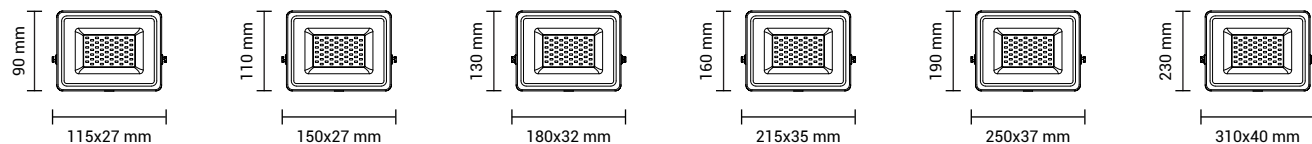
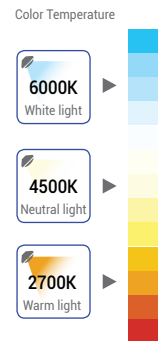





IP65



HIGH

Lumen



3 Years

Warranty

## LED SMD FLOODLIGHT PF>0.9

High Line - Driverless

20W



Lumens

FL5472/FL5473

5700K/3000K

20W

AC : 175-265V

1800lm

120°

Ra>80

IP65

222x140x17 mm

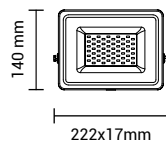

30W



Lumens

FL5474/FL5475

5700K/3000K

30W

AC : 175-265V

2700lm

120°

Ra>80

IP65

265x175x18 mm

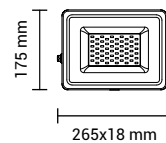

50W



Lumens

FL5476/FL5477

5700K/3000K

50W

AC : 175-265V

4500lm







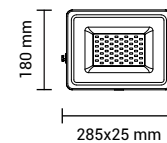

120°

Ra>80

IP65

285x180x25 mm



-  SKU No.
-  Light Color
-  Watts
-  Input Voltage
-  Flux
-  Beam Angle
-  CRI
-  IP Rating
-  Dimension

Color Temperature

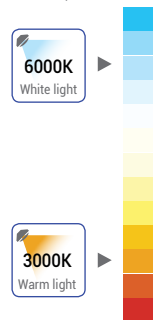



**10W SMD FLOODLIGHT**

Rechargeable + Battery

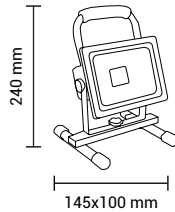

Car Charger Included

SKU No.	FL5406
Light Color	4500K
Watts	10W
Input Voltage	AC : 200-240V or 12V DC
Flux	800lm
Beam Angle	120°
CRI	Ra>80
IP Rating	IP65
Dimension	145x240x100 mm

Color Temperature

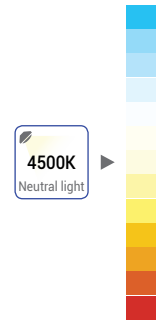

Rechargeable



Lumens



120°



IP65



**20W SMD FLOODLIGHT**

Rechargeable + Battery

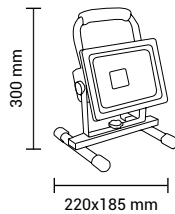

Car Charger Included

SKU No.	FL5407
Light Color	4500K
Watts	20W
Input Voltage	AC : 200-240V or 12V DC
Flux	1600lm
Beam Angle	120°
CRI	Ra>80
IP Rating	IP65
Dimension	220x185x300 mm

Color Temperature

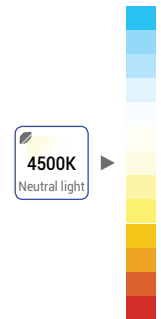

Rechargeable



Lumens



120°



IP65



## LED STREET AND INDUSTRIAL LIGHTS



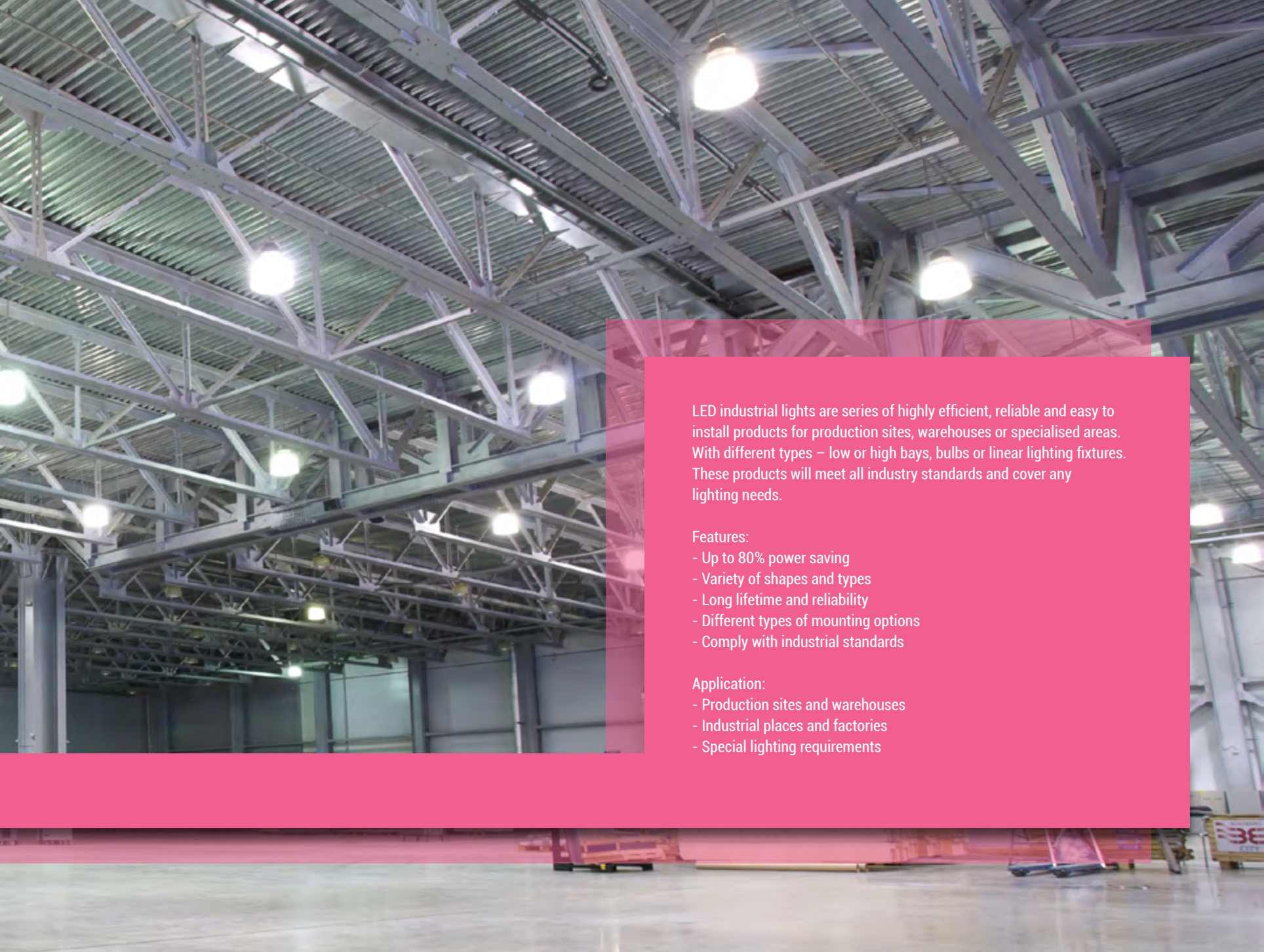

LED industrial lights are series of highly efficient, reliable and easy to install products for production sites, warehouses or specialised areas. With different types – low or high bays, bulbs or linear lighting fixtures. These products will meet all industry standards and cover any lighting needs.

**Features:**

- Up to 80% power saving
- Variety of shapes and types
- Long lifetime and reliability
- Different types of mounting options
- Comply with industrial standards

**Application:**

- Production sites and warehouses
- Industrial places and factories
- Special lighting requirements



IP65



120°



Time Switch



Intelligent light control

**LED STREET LIGHT**  
SOLAR POWER + BATTERY

**40W**



Lumens

**60W**



Lumens

- SKU No.
- Light Color
- Watts
- Battery
- Flux
- Beam Angle
- CRI
- IP Rating
- Dimension

SKU No.	SL9135
Light Color	6000K
Watts	40W
Battery	3.2V / 16.5Ah
Flux	890lm
Beam Angle	120°
CRI	Ra>70
IP Rating	IP65
Dimension	490x240x65 mm

SKU No.	SL9136
Light Color	6000K
Watts	60W
Battery	3.2V / 22Ah
Flux	990lm
Beam Angle	120°
CRI	Ra>70
IP Rating	IP65
Dimension	650x250x65 mm

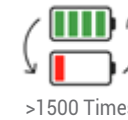

Wireless Remote Control



Color Temperature



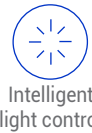

**LED STREET LIGHT**  
SOLAR POWER + BATTERY

**100W** **1950**  
Lumens

SKU No.	SL9137
Light Color	6000K
Watts	100W
Battery	6.4V / 16.5Ah
Flux	1950lm
Beam Angle	120°
CRI	Ra>70
IP Rating	IP65
Dimension	400x360x17 mm

**150W** **2500**  
Lumens

SKU No.	SL9138
Light Color	6000K
Watts	150W
Battery	3.2V / 22Ah
Flux	2500lm
Beam Angle	120°
CRI	Ra>70
IP Rating	IP65
Dimension	644x358x17 mm

- SKU No.
- Light Color
- Watts
- Battery
- Flux
- Beam Angle
- CRI
- IP Rating
- Dimension

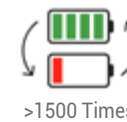

Wireless Remote Control



Color Temperature

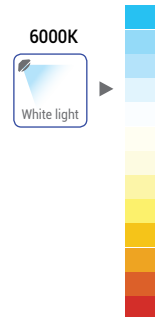



IP54



HIGH  
Lumen



5  
Years  
Warranty

OSRAM  
Chips

**LED INDUSTRIAL PF>0.9**

High Bay - UFO

**100W** **10000**  
Lumens

**150W** **15000**  
Lumens

**200W** **20000**  
Lumens

- SKU No.**
- Light Color**
- Watts**
- Input Voltage**
- Flux**
- Beam Angle**
- CRI**
- IP Rating**
- Dimension**

SKU No.	HB8140
Light Color	5700K
Watts	100W
Input Voltage	AC : 220-240V
Flux	10 000lm
Beam Angle	90°
CRI	Ra>70
IP Rating	IP54
Dimension	ø300x110 mm

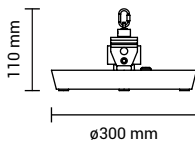

SKU No.	HB8141
Light Color	5700K
Watts	150W
Input Voltage	AC : 220-240V
Flux	15 000lm
Beam Angle	90°
CRI	Ra>70
IP Rating	IP54
Dimension	ø400x140 mm

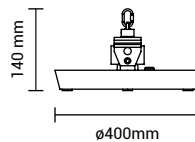

SKU No.	HB8126
Light Color	5700K
Watts	200W
Input Voltage	AC : 220-240V
Flux	20 000lm
Beam Angle	90°
CRI	Ra>70
IP Rating	IP54
Dimension	ø405x160 mm

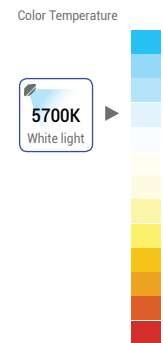
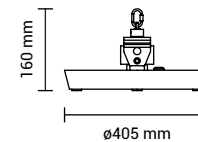



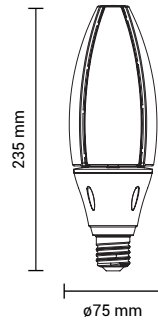

SKU No.	HB220
Light Color	5700K
Watts	25W
Input Voltage	AC : 110-240V
Flux	2500lm
Beam Angle	270°
CRI	Ra>70
IP Rating	IP20
Dimension	ø75x235 mm

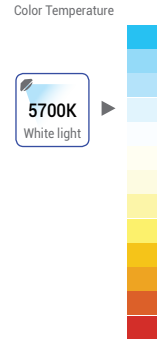

**25W LED BULB E27**

INDUSTRIAL PF>0.9

2500 Lumens    
 E27    
 270°    
 IP20

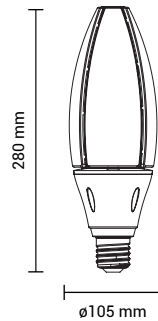

SKU No.	HB221
Light Color	5700K
Watts	50W
Input Voltage	AC : 110-240V
Flux	5000lm
Beam Angle	270°
CRI	Ra>70
IP Rating	IP20
Dimension	ø105x280 mm

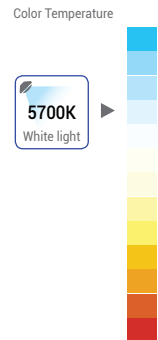

**50W LED BULB E40**

INDUSTRIAL PF>0.9

5000 Lumens    
 E40    
 270°    
 IP20



IP65



60°



Lumen

## LED INDUSTRIAL LIGHT

### HIGH BAY - UFO

<b>50W</b>		<b>100W</b>		<b>150W</b>		<b>200W</b>	
	Lumens		Lumens		Lumens		Lumens

- SKU No.**
- Light Color**
- Watts**
- Input Voltage**
- Flux**
- Beam Angle**
- CRI**
- IP Rating**
- Dimension**

HB8142/HB8143	HB8144/HB8145	HB8146/HB8147	HB8148/HB8149
6000K/4500K	6000K/4500K	6000K/4500K	6000K/4500K
50W	100W	150W	200W
AC : 180-260V	AC : 180-260V	AC : 180-260V	AC : 180-260V
5 000lm	10 000lm	15 000lm	20 000lm
60°	60°	60°	60°
Ra>70	Ra>70	Ra>70	Ra>70
IP65	IP65	IP65	IP65
ø225x73 mm	ø280x73 mm	ø330x73 mm	ø400x73 mm

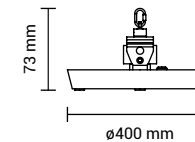
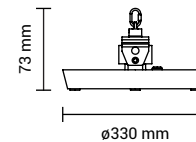
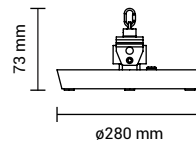
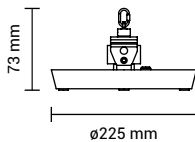

Color Temperature

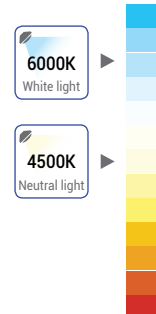



IP44



120°x60°



Lumen

## LED INDUSTRIAL LIGHT

### LINEAR HIGH BAY

**50W**



Lumens

**100W**



Lumens

**150W**











Lumens

**200W**



Lumens

-  **SKU No.**
-  **Light Color**
-  **Watts**
-  **Input Voltage**
-  **Flux**
-  **Beam Angle**
-  **CRI**
-  **IP Rating**
-  **Dimension**

SKU No.	HB8151/HB8152	HB8153/HB8154	HB8155/HB8156	HB8157/HB8158
Light Color	6000K/4500K	6000K/4500K	6000K/4500K	6000K/4500K
Watts	50W	100W	150W	200W
Input Voltage	AC : 220-240V	AC : 220-240V	AC : 220-240V	AC : 220-240V
Flux	5 000lm	10 000lm	15 000lm	20 000lm
Beam Angle	120°x60°	120°x60°	120°x60°	120°x60°
CRI	Ra>70	Ra>70	Ra>70	Ra>70
IP Rating	IP44	IP44	IP44	IP44
Dimension	315x115x105 mm	570x115x105 mm	845x115x105 mm	1110x115x105 mm

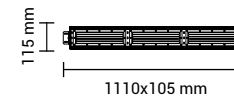
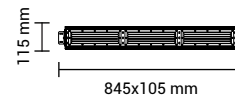
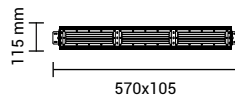
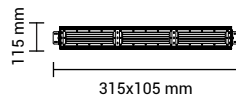

Color Temperature





Lumen



IP54

OSRAM  
Chips









90°



Warranty

## LED INDUSTRIAL LIGHT

### HIGH BAY - UFO

-  SKU No.
-  Light Color
-  Watts
-  Input Voltage
-  Flux
-  Beam Angle
-  CRI
-  IP Rating
-  Dimension

**30W**

Lumens

SKU No.	HB8122
Light Color	5700K
Watts	30W
Input Voltage	AC : 220-240V
Flux	2400lm
Beam Angle	90°
CRI	Ra>70
IP Rating	IP54
Dimension	ø335x262 mm

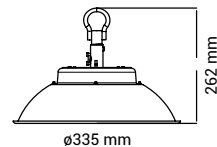

ø335 mm

**55W**

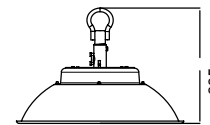

Lumens

SKU No.	HB8123
Light Color	5700K
Watts	55W
Input Voltage	AC : 220-240V
Flux	4400lm
Beam Angle	90°
CRI	Ra>70
IP Rating	IP54
Dimension	ø435x295 mm

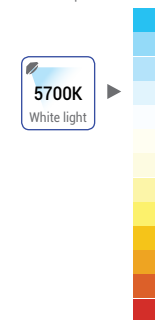

ø435 mm

Color Temperature





OSRAM  
Chips



**LED INDUSTRIAL LIGHT**

**HIGH BAY**

**100W** **10000**  
Lumens

**150W** **15000**  
Lumens

**200W** **20000**  
Lumens

- SKU No.**
- Light Color**
- Watts**
- Input Voltage**
- Flux**
- Beam Angle**
- CRI**
- IP Rating**
- Dimension**

SKU No.	HB8124
Light Color	5700K
Watts	100W
Input Voltage	AC : 220-240V
Flux	10 000lm
Beam Angle	60°
CRI	Ra>80
IP Rating	IP54
Dimension	ø402x349 mm

SKU No.	HB8125
Light Color	5700K
Watts	150W
Input Voltage	AC : 220-240V
Flux	15 000lm
Beam Angle	60°
CRI	Ra>80
IP Rating	IP54
Dimension	ø485x290 mm

SKU No.	HB8127
Light Color	5700K
Watts	200W
Input Voltage	AC : 220-240V
Flux	20 000lm
Beam Angle	60°
CRI	Ra>80
IP Rating	IP54
Dimension	ø520x379 mm

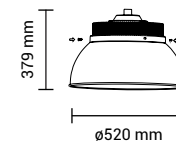
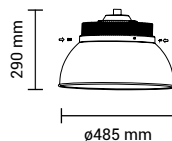
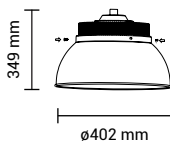

Color Temperature

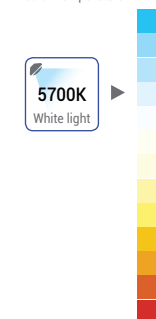



IP65



HIGH Lumen



5 Years Warranty



Adjusting angle

**LED STREET LIGHT PF>0.9**

2 PCS BOX

**30W** **4050**  
Lumens

**50W** **6750**  
Lumens

**60W** **8100**  
Lumens

SKU No.	SL9156
Light Color	5700K
Watts	30W
Input Voltage	AC : 100-240V
Flux	4050lm
Beam Angle	120°
CRI	Ra>70
IP Rating	IP65
Dimension	425x117x76 mm

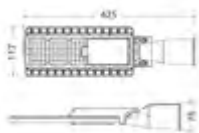

SKU No.	SL9157
Light Color	5700K
Watts	50W
Input Voltage	AC : 100-240V
Flux	6750lm
Beam Angle	120°
CRI	Ra>70
IP Rating	IP65
Dimension	494x155x76 mm

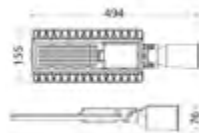

SKU No.	SL9158
Light Color	5700K
Watts	60W
Input Voltage	AC : 100-240V
Flux	8100lm
Beam Angle	120°
CRI	Ra>70
IP Rating	IP65
Dimension	494x155x76 mm

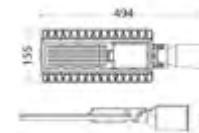

Color Temperature

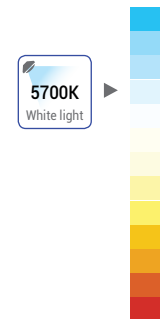



**LED STREET LIGHT**

<b>20W</b>		<b>30W</b>		<b>50W</b>		<b>80W</b>		<b>100W</b>	
	Lumens		Lumens		Lumens		Lumens		Lumens

	SKU No.	SL9171	SL9171-S	SL9172	SL9173	SL9174
	Light Color	6000K	6000K	6000K	6000K	6000K
	Watts	20W	30W	50W	80W	100W
	Input Voltage	AC : 220-240V	AC : 220-240V	AC : 220-240V	AC : 220-240V	AC : 220-240V
	Flux	2000lm	3000lm	5000lm	8000lm	10000lm
	Beam Angle	120°	120°	120°	120°	120°
	CRI	Ra>70	Ra>70	Ra>70	Ra>70	Ra>70
	IP Rating	IP65	IP65	IP65	IP65	IP65
	Dimension	300x105x50 mm	300x105x50 mm	405x160x50 mm	500x190x70 mm	600x220x70 mm

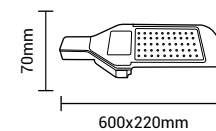
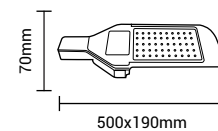
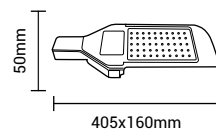
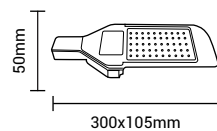
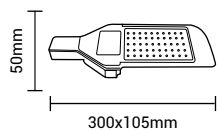
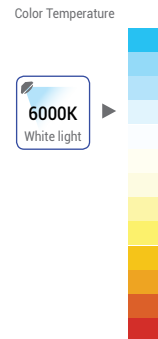





SKU No. SL9119  
 Dimension  $\phi 80 \times 325$  mm

**LED STREET LIGHT PF>0.95**

NICHIA , Bridgelux 3030 LED

5 Years  
 Warranty

IP65

120°

**ADAPTER (60mm-60mm)**  
 ADJUSTABLE ANGLE

50W **6000** Lumens      75W **9000** Lumens      100W **12000** Lumens      150W **14250** Lumens      200W **19000** Lumens

SKU No.	SL9183	SL9184	SL9185	SL9181	SL9182
Light Color	5700K	5700K	5700K	5700K	5700K
Watts	50W	75W	100W	150W	200W
Input Voltage	AC:120-240V	AC:120-240V	AC:120-240V	AC:220-240V	AC:220-240V
Flux	6000lm	9000lm	12000lm	14250lm	19000lm
Beam Angle	120°	120°	120°	120°	120°
CRI	Ra>70	Ra>70	Ra>70	Ra>70	Ra>70
IP Rating	IP65	IP65	IP65	IP65	IP65
Dimension	420x190x120 mm	420x190x120 mm	540x240x150 mm	770x305x156 mm	770x305x156 mm

Color Temperature

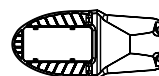
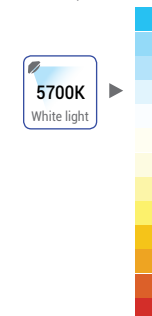



IP65



HIGH  
Lumen



5  
Years  
Warranty

**LED STADIUM FLOODLIGHT PF>0.9**

**100W** **10000**  
Lumens

**150W** **15000**  
Lumens

**240W** **24000**  
Lumens

**480W** **48000**  
Lumens

- SKU No.**
- Light Color**
- Watts**
- Input Voltage**
- Flux**
- Beam Angle**
- CRI**
- IP Rating**
- Dimension**

SL9175
5700K
100W
AC : 100-240V
10 000lm
120°
Ra>70
IP65
364x273x56 mm

SL9176
5700K
150W
AC : 100-240V
15 000lm
120°
Ra>70
IP65
415x308x56 mm

SL9177
5700K
240W
AC : 100-240V
24 000lm
90°
Ra>70
IP65
425x341x68 mm

SL9178
5700K
480W
AC : 100-240V
48 000m
90°
Ra>70
IP65
649x448x68 mm

Color Temperature

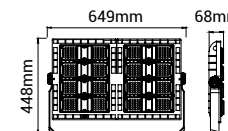
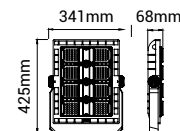
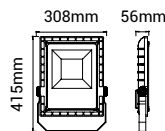
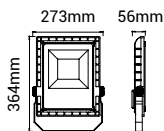
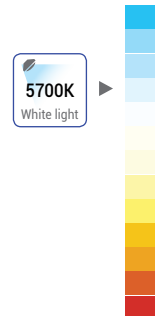

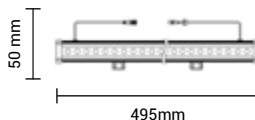

**9W LED Wall Washer**  
9x1W LED Chip

SKU No.	WW7134/WW7131
Light Color	6000K/2700K
Watts	9W
Input Voltage	AC : 180-265V
Flux	960lm
Beam Angle	15°
CRI	Ra>80
IP Rating	IP65
Dimension	495x58x50 mm

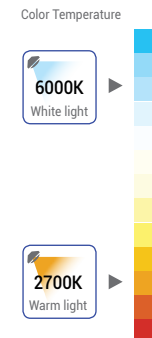

EPISTAR Chips



Lumens

15°

IP65

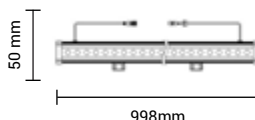

**18W LED Wall Washer**  
18x1W LED Chip

SKU No.	WW7135/WW7132
Light Color	6000K/2700K
Watts	18W
Input Voltage	AC : 180-265V
Flux	1440lm
Beam Angle	15°
CRI	Ra>80
IP Rating	IP65
Dimension	998x58x50 mm

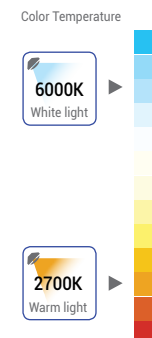

EPISTAR Chips



Lumens

15°

IP65



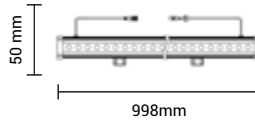

**36W LED Wall Washer**

36x1W LED Chip

SKU No.	WW7136/WW7133
Light Color	6000K/2700K
Watts	36W
Input Voltage	AC : 180-265V
Flux	2880lm
Beam Angle	15°
CRI	Ra>80
IP Rating	IP65
Dimension	988x58x50 mm

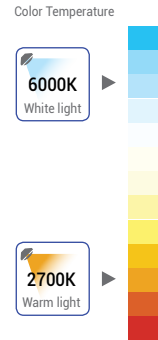

EPISTAR  
Chips

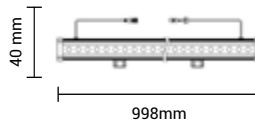

**18W LED Wall Washer 24V**

18x1W LED Chip

SKU No.	WW7116
Light Color	RGB
Watts	12W
Input Voltage	DC : 24V
Flux	1440lm
Beam Angle	15°
CRI	Ra>80
IP Rating	IP65
Dimension	988x58x40 mm



EPISTAR  
Chips





IP67











15°

### LED Wall Washers

**9W**  **720**  
Lumens

**10W**  **800**  
Lumens

**12W**  **960**  
Lumens

-  **SKU No.**
-  **Light Color**
-  **Watts**
-  **Input Voltage**
-  **Flux**
-  **Beam Angle**
-  **CRI**
-  **IP Rating**
-  **Dimension**

SKU No.	WW7126
Light Color	2800K
Watts	9W
Input Voltage	AC : 220-240V
Flux	720lm
Beam Angle	15°
CRI	Ra>70
IP Rating	IP67
Dimension	300x60x60 mm







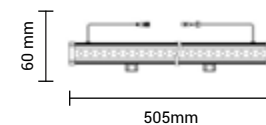
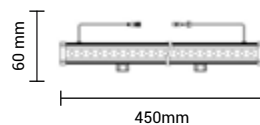
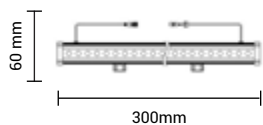
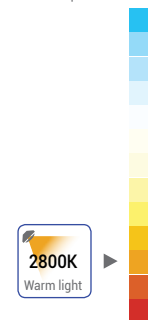

SKU No.	WW7127
Light Color	2800K
Watts	10W
Input Voltage	AC : 220-240V
Flux	800lm
Beam Angle	15°
CRI	Ra>70
IP Rating	IP67
Dimension	450x60x60 mm

SKU No.	WW7128
Light Color	2800K
Watts	12W
Input Voltage	AC : 220-240V
Flux	960lm
Beam Angle	15°
CRI	Ra>70
IP Rating	IP67
Dimension	505x60x60 mm









Color Temperature





-  **SKU No.** 7121
-  **Light Color** 2700K
-  **Watts** 36W
-  **Input Voltage** AC : 220-240V
-  **Flux** 2880lm
-  **Beam Angle** 15°
-  **CRI** Ra>70
-  **IP Rating** IP67
-  **Dimension** 333x200x120 mm



-  **SKU No.** 7122
-  **Light Color** 2700K
-  **Watts** 48W
-  **Input Voltage** AC : 220-240V
-  **Flux** 3840lm
-  **Beam Angle** 15°
-  **CRI** Ra>70
-  **IP Rating** IP67
-  **Dimension** 333x240x116 mm







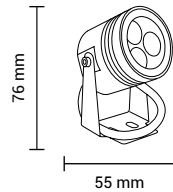

### 36W LED Wall Washer

Square

### 48W LED Wall Washer

Square



-  **SKU No.** WW7123
-  **Light Color** 2700K
-  **Watts** 3W
-  **Input Voltage** AC :180-265V
-  **Flux** 240lm
-  **Beam Angle** 8°
-  **CRI** Ra>80
-  **IP Rating** IP67
-  **Dimension** ø55x76 mm

Color Temperature

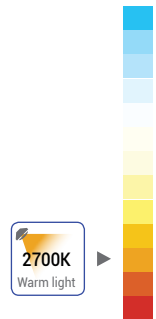

### 3W LED Wall Washer

Spot Light

 240  
Lumens

 8°

 IP67





## LED WALL AND OUTDOOR LIGHTS





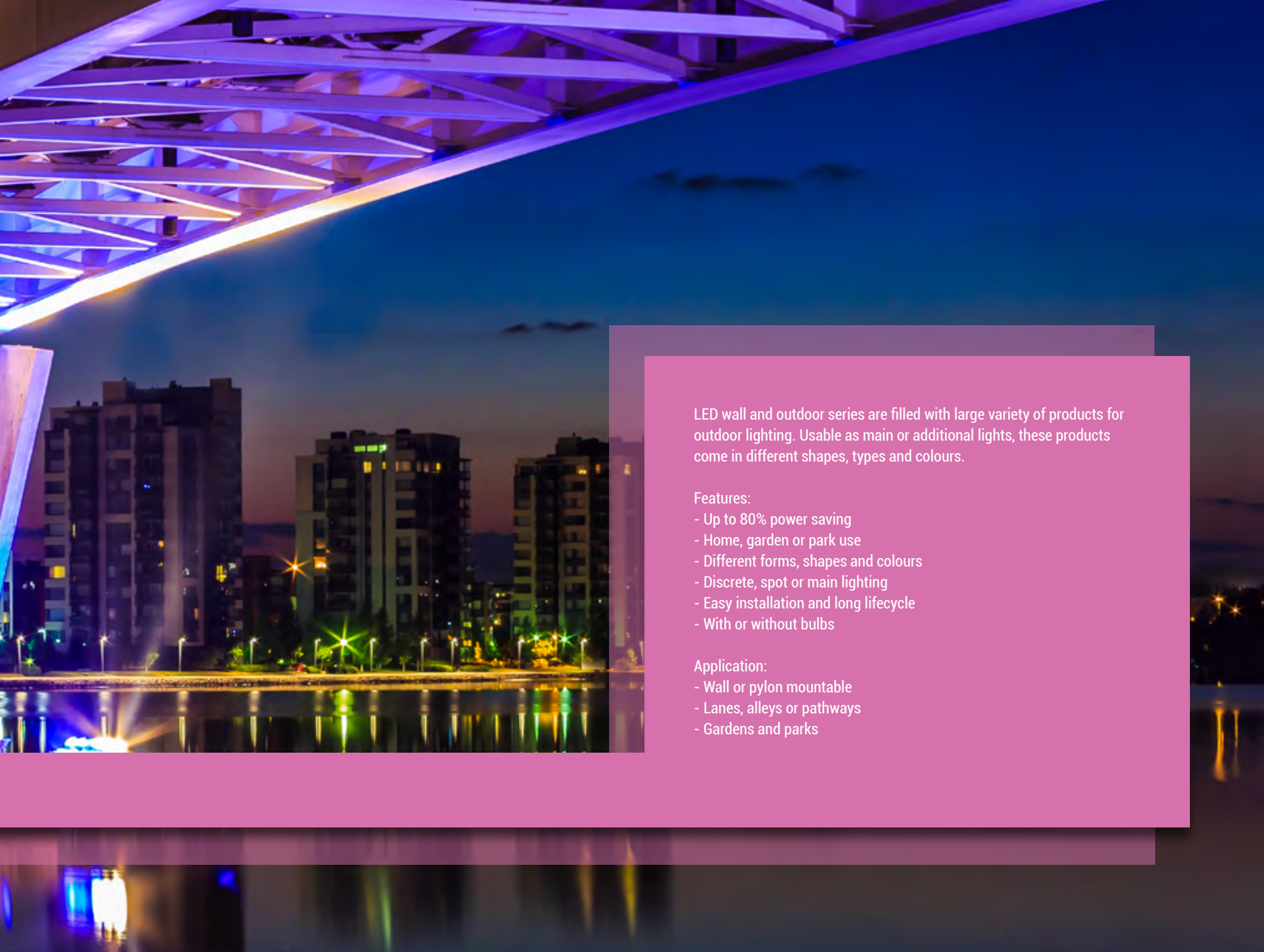

LED wall and outdoor series are filled with large variety of products for outdoor lighting. Usable as main or additional lights, these products come in different shapes, types and colours.

Features:

- Up to 80% power saving
- Home, garden or park use
- Different forms, shapes and colours
- Discrete, spot or main lighting
- Easy installation and long lifecycle
- With or without bulbs

Application:

- Wall or pylon mountable
- Lanes, alleys or pathways
- Gardens and parks





IP65



120°-145°

## LED WALL /CEILING LIGHT 15W

-  **SKU No.**
-  **Light Color**
-  **Watts**
-  **Input Voltage**
-  **Flux**
-  **Beam Angle**
-  **CRI**
-  **IP Rating**
-  **Dimension**

	ROUND	SQUARE	ROUND	SQUARE
SKU No.	WL7528/WL7529	WL7530/WL7531	WL7532/WL7533	WL7534/WL7535
Light Color	3000K/4200K	3000K/4200K	3000K/4200K	3000K/4200K
Watts	15W	15W	15W	15W
Input Voltage	AC : 220-240V	AC : 220-240V	AC : 220-240V	AC : 220-240V
Flux	750lm	750lm	1000lm	1000lm
Beam Angle	120°	120°	145°	145°
CRI	Ra>80	Ra>80	Ra>80	Ra>80
IP Rating	IP65	IP65	IP65	IP65
Dimension	ø169x100 mm	160x160x100 mm	ø169x100 mm	160x160x100 mm

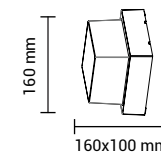
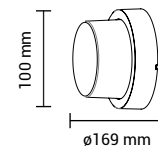
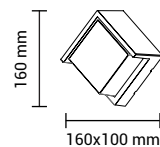
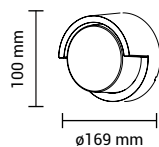

Color Temperature

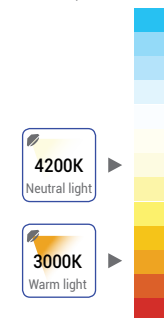



**LED WALL LIGHT**  
TRIANGLE 6W

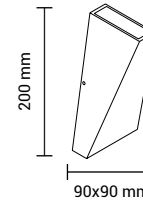

Body Color

**WHITE 6W**

**BLACK 6W**

**GRAY 6W**

SKU No.

WL7469/W7472

WL7470/W7473

WL7471/W7474

Light Color

3000K/4200K

3000K/4200K

3000K/4200K

Watts

6W

6W

6W

Input Voltage

AC : 220-240V

AC : 220-240V

AC : 220-240V

Flux

660 lm

660 lm

660 lm

Beam Angle

Up 15° - Down 90°

Up 15° - Down 90°

Up 15° - Down 90°

CRI

Ra>80

Ra>80

Ra>80

IP Rating

IP54

IP54

IP54

Dimension

90x90x200 mm

90x90x200 mm

90x90x200 mm

Color Temperature

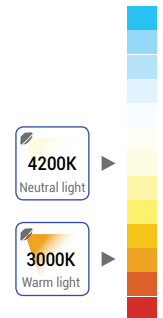

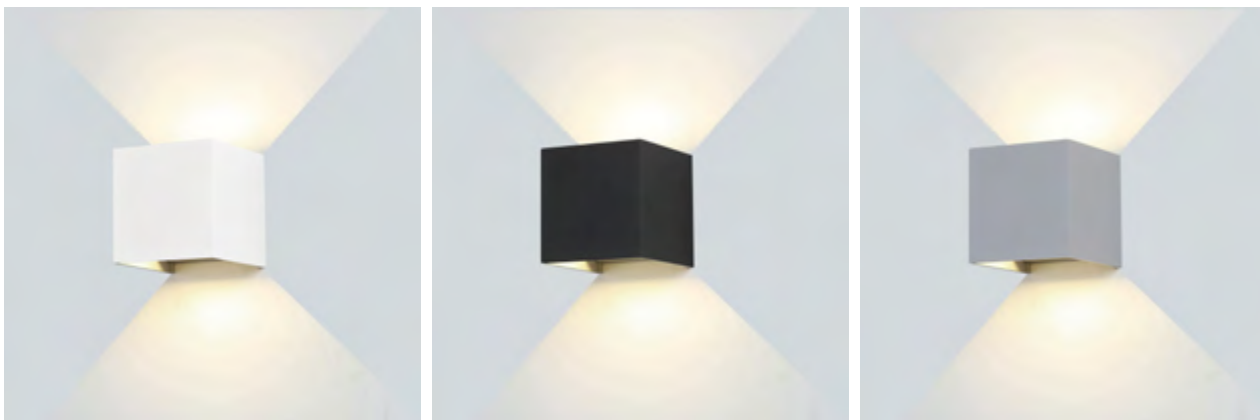

**LED WALL LIGHT**  
SQUARE 6W-12W

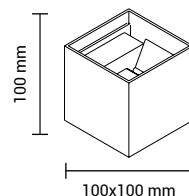

Adjustable Beam Angles

	WHITE 6W	BLACK 6W	GRAY 6W	WHITE 12W	BLACK 12W	GRAY 12W
Body Color	WHITE 6W	BLACK 6W	GRAY 6W	WHITE 12W	BLACK 12W	GRAY 12W
SKU No.	WL7451/WL7454	WL7452/WL7455	WL7453/WL7456	WL7457/WL7460	WL7458/WL7461	WL7459/WL7462
Light Color	3000K/4000K	3000K/4000K	3000K/4000K	3000K/4000K	3000K/4000K	3000K/4000K
Watts	6W	6W	6W	12W	12W	12W
Input Voltage	AC : 220-240V	AC : 220-240V	AC : 220-240V	AC : 220-240V	AC : 220-240V	AC : 220-240V
Flux	660lm	660lm	660lm	1320lm	1320lm	1320lm
Beam Angle	0° to 90°	0° to 90°	0° to 90°	0° to 90°	0° to 90°	0° to 90°
CRI	Ra>80	Ra>80	Ra>80	Ra>80	Ra>80	Ra>80
IP Rating	IP54	IP54	IP54	IP54	IP54	IP54
Dimension	100x100 mm	100x100 mm	100x100 mm	100x100 mm	100x100 mm	100x100 mm

Color Temperature

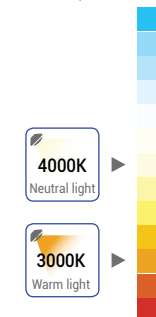



**LED WALL LIGHT**  
**ROUND 6W**

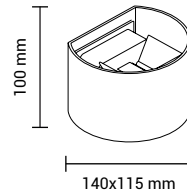

Adjustable Beam Angles

Body Color

**WHITE 6W**

**BLACK 6W**

**GRAY 6W**

SKU No.

WL7463/WL7466

WL7464/WL7467

WL7465/WL7468

Light Color

3000K/4000K

3000K/4000K

3000K/4000K

Watts

6W

6W

6W

Input Voltage

AC : 220-240V

AC : 220-240V

AC : 220-240V

Flux

660 lm

660 lm

660 lm

Beam Angle

0° to 90°

0° to 90°

0° to 90°

CRI

Ra>80

Ra>80

Ra>80

IP Rating

IP54

IP54

IP54

Dimension

140x115x100 mm

140x115x100 mm

140x115x100 mm

Color Temperature

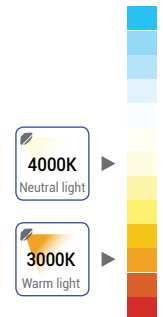

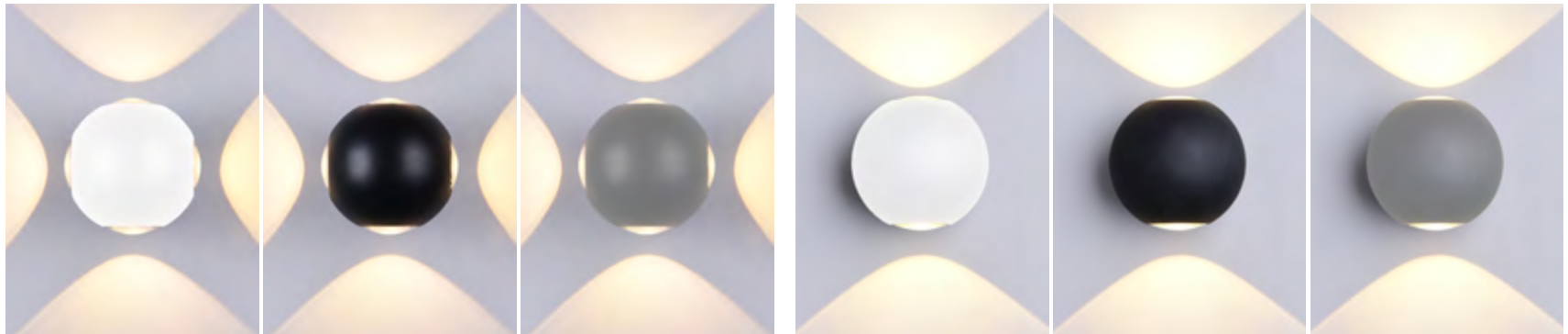

**LED WALL LIGHT**  
ROUND 4W- 6W CREE

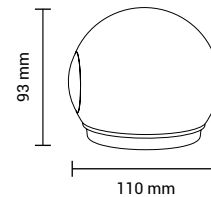
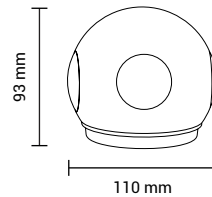

	WHITE 4-Beam	BLACK 4-Beam	GRAY 4-Beam	WHITE 2-Beam	BLACK 2-Beam	GRAY 2-Beam
Body Color	WHITE 4-Beam	BLACK 4-Beam	GRAY 4-Beam	WHITE 2-Beam	BLACK 2-Beam	GRAY 2-Beam
SKU No.	WL7487/WL7490	WL7488/WL7491	WL7489/WL7492	WL7493/WL7496	WL7494/WL7497	WL7495/WL7498
Light Color	3000K/4000K	3000K/4000K	3000K/4000K	3000K/4000K	3000K/4000K	3000K/4000K
Watts	4W	4W	4W	6W	6W	6W
Input Voltage	AC : 220-240V	AC : 220-240V	AC : 220-240V	AC : 220-240V	AC : 220-240V	AC : 220-240V
Flux	440 lm	440 lm	440 lm	660 lm	660 lm	660 lm
Beam Angle	90°	90°	90°	90°	90°	90°
CRI	Ra>80	Ra>80	Ra>80	Ra>80	Ra>80	Ra>80
IP Rating	IP54	IP54	IP54	IP54	IP54	IP54
Dimension	ø110x93 mm	ø110x93 mm	ø110x93 mm	ø110x93 mm	ø110x93 mm	ø110x93 mm

Color Temperature

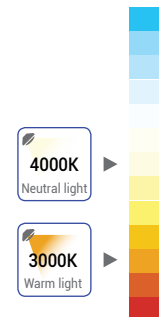



Rotatable 355°

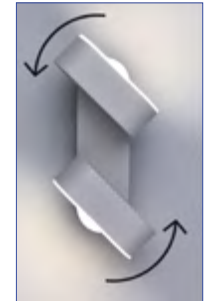

Rotatable 355°



IP54



120°

## LED WALL LIGHT

6W and 2x6W

	WHITE 6W	BLACK 6W	GRAY 6W	WHITE 12W	BLACK 12W	GRAY 12W
Body Color	WHITE 6W	BLACK 6W	GRAY 6W	WHITE 12W	BLACK 12W	GRAY 12W
SKU No.	WL7475/WL7478	WL7476/WL7479	WL7477/WL7480	WL7481/WL7484	WL7482/WL7485	WL7483/WL7486
Light Color	3000K/4000K	3000K/4000K	3000K/4000K	3000K/4000K	3000K/4000K	3000K/4000K
Watts	6W	6W	6W	12W	12W	12W
Input Voltage	AC : 220-240V	AC : 220-240V	AC : 220-240V	AC : 220-240V	AC : 220-240V	AC : 220-240V
Flux	660 lm	660 lm	660 lm	1320 lm	1320 lm	1320 lm
Beam Angle	120°	120°	120°	120°	120°	120°
CRI	Ra>80	Ra>80	Ra>80	Ra>80	Ra>80	Ra>80
IP Rating	IP54	IP54	IP54	IP54	IP54	IP54
Dimension	110x54x97mm	110x54x97mm	110x54x97mm	221x54x97mm	221x54x97mm	221x54x97mm

Color Temperature

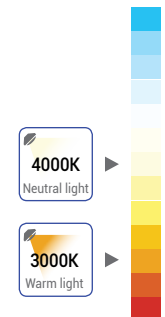





SKU No.	DL2296
Light Color	2800K
Watts	8W
Input Voltage	AC : 200-240V
Flux	520lm
Beam Angle	120°
CRI	Ra>80
IP Rating	IP20
Dimension	155x80x35 mm

Color Temperature

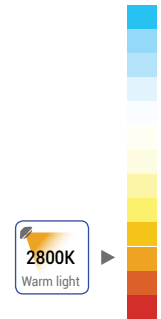

## LED WALL LIGHT 8W

SANDY WHITE



SKU No.	WL7526/WL7527
Light Color	3000K/4200K
Watts	12W
Input Voltage	AC : 200-240V
Flux	780lm
Beam Angle	120°
CRI	Ra>80
IP Rating	IP65
Dimension	230x110x76 mm

Color Temperature

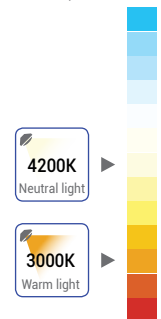









## LED WALL LIGHT 12W

BULKHEAD GRAY



**NEW**



-  **SKU No.**
-  **Light Color**
-  **Watts**
-  **Input Voltage**
-  **Flux**
-  **Beam Angle**
-  **CRI**
-  **IP Rating**
-  **Dimension**

SKU No.	WL7403/WL7404
Light Color	3000K/4000K
Watts	12W
Input Voltage	AC : 200-240V
Flux	780lm
Beam Angle	6°
CRI	Ra>80
IP Rating	IP54
Dimension	230x110x76 mm

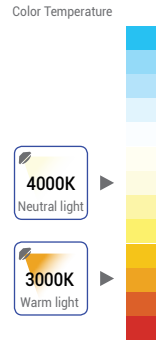







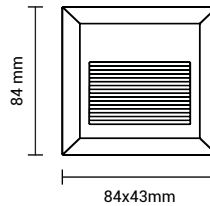

**LED WALL LIGHT 9W**  
BLACK



**NEW**



-  **SKU No.**
-  **Light Color**
-  **Watts**
-  **Input Voltage**
-  **Flux**
-  **Beam Angle**
-  **CRI**
-  **IP Rating**
-  **Dimension**

SKU No.	WL7521
Light Color	4200K
Watts	3W
Input Voltage	AC : 200-240V
Flux	195lm
Beam Angle	58°
CRI	Ra>80
IP Rating	IP65
Dimension	84x84x43 mm

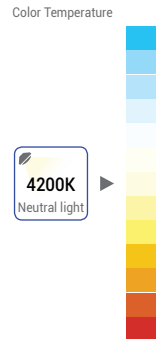

**LED STEP LIGHT 3W**  
SQUARE WHITE



NEW



## LED STEP LIGHT 2W

### ROUND

Body Color

BLACK 2W

WHITE 2W

GRAY 2W

SKU No.

WL7503/WL7504

WL7505/WL7506

WL7507/WL7508

Light Color

3000K/4200K

3000K/4200K

3000K/4200K

Watts

2W

2W

2W

Input Voltage

AC : 220-240V

AC : 220-240V

AC : 220-240V

Flux

80lm

80lm

80lm

Beam Angle

55°

55°

55°

CRI

Ra>80

Ra>80

Ra>80

IP Rating

IP65

IP65

IP65

Dimension

ø150x27 mm

ø150x27 mm

ø150x27 mm

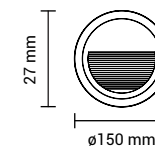
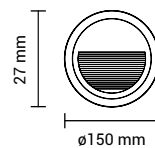
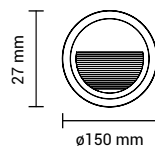

Color Temperature

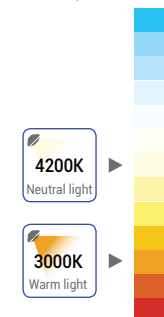



**LED STEP LIGHT 2W**  
SQUARE

Body Color

SKU No.

Light Color

Watts

Input Voltage

Flux

Beam Angle

CRI

IP Rating

Dimension

**BLACK 2W**

WL7509/WL7510

3000K/4200K

2W

AC : 220-240V

80lm

55°

Ra>80

IP65

124x124x27 mm

**WHITE 2W**

WL7511/WL7512

3000K/4200K

2W

AC : 220-240V

80lm

55°

Ra>80

IP65

124x124x27 mm

**GRAY 2W**

WL7513/WL7514

3000K/4200K

2W

AC : 220-240V

80lm

55°

Ra>80

IP65

124x124x27 mm

Color Temperature

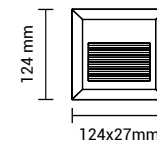
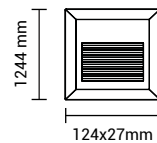
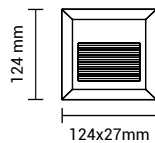
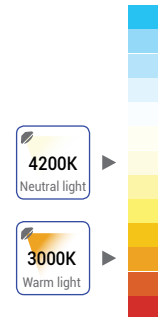



**LED SMD STEP LIGHT 3W**  
RECTANGULAR



Body Color

BLACK 3W

WHITE 3W

GRAY 3W

SKU No.

WL7515/WL7516

WL7517/WL7518

WL7519/WL7520

Light Color

3000K/4200K

3000K/4200K

3000K/4200K

Watts

3W

3W

3W

Input Voltage

AC : 220-240V

AC : 220-240V

AC : 220-240V

Flux

100lm

100lm

100lm

Beam Angle

65°

65°

65°

CRI

Ra>80

Ra>80

Ra>80

IP Rating

IP65

IP65

IP65

Dimension

280x80x28 mm

280x80x28 mm

280x80x28 mm

Color Temperature

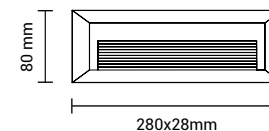
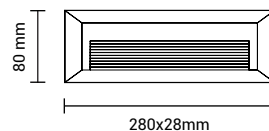
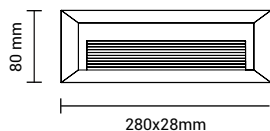
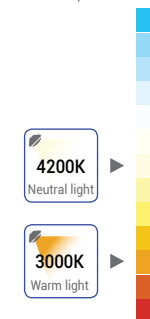



<b>SKU No.</b>	WL7522/WL7523
<b>Light Color</b>	3000K/4200K
<b>Watts</b>	3W
<b>Input Voltage</b>	AC : 200-240V
<b>Flux</b>	90lm
<b>Beam Angle</b>	34°
<b>CRI</b>	Ra>80
<b>IP Rating</b>	IP65
<b>Dimension</b>	ø80x51 mm

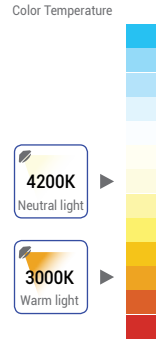

**LED STEP LIGHT 3W**  
ROUND WHITE



<b>SKU No.</b>	WL7524/WL7525
<b>Light Color</b>	3000K/4200K
<b>Watts</b>	3W
<b>Input Voltage</b>	AC : 200-240V
<b>Flux</b>	90lm
<b>Beam Angle</b>	34°
<b>CRI</b>	Ra>80
<b>IP Rating</b>	IP65
<b>Dimension</b>	80x80x51 mm

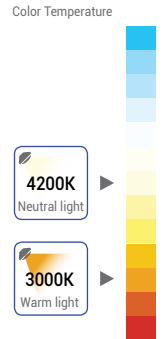

**LED STEP LIGHT 3W**  
SQUARE WHITE









IP44







E27 Holder

**WALL FITTING**

E27 Socket

-  **SKU No.** WL7422
-  **Body Color** Stainless Steel
-  **E27 Holder** MAX 16W
-  **Material** Aluminium
-  **Dimension** 303x100x91 mm

-  **SKU No.** WL7423
-  **Body Color** Stainless Steel
-  **E27 Holder** MAX 16W
-  **Material** Aluminium
-  **Dimension** 303x100x91 mm



IP44





E27 Holder

**WALL FITTING**

E27 Socket

-  **SKU No.** WL7401
-  **Body Color** Matt Black
-  **E27 Holder** MAX60W
-  **Material** Aluminium
-  **Dimension** 245x180x93 mm

-  **SKU No.** WL7402
-  **Body Color** Matt White
-  **E27 Holder** MAX 60W
-  **Material** Aluminium
-  **Dimension** 245x180x93 mm

-  **SKU No.** WL7421
-  **Body Color** Dark Fray
-  **E27 Holder** MAX 16W
-  **Material** Aluminium
-  **Dimension** 165x106x74mm















**NEW**

**WALL FITTING**  
GU10 Socket







-  **SKU No.** WL7443
-  **Body Color** Black
-  **Socket** GU10
-  **Material** Aluminium
-  **Dimension** 100x66x92 mm



-  **SKU No.** WL7444
-  **Body Color** White
-  **Socket** GU10
-  **Material** Aluminium
-  **Dimension** 100x66x92 mm



-  **SKU No.** WL7445
-  **Body Color** Silver
-  **Socket** GU10
-  **Material** Aluminium
-  **Dimension** 100x66x92 mm



IP65







GU10 Holder





**NEW**

**WALL FITTING**  
Two GU10 Sockets







-  **SKU No.** WL7446
-  **Body Color** Black
-  **Socket** 2 x GU10
-  **Material** Aluminium
-  **Dimension** 92x68x150 mm



-  **SKU No.** WL7447
-  **Body Color** White
-  **Socket** 2 x GU10
-  **Material** Aluminium
-  **Dimension** 92x68x150 mm



-  **SKU No.** WL7448
-  **Body Color** Silver
-  **Socket** 2 x GU10
-  **Material** Aluminium
-  **Dimension** 92x68x150 mm



IP65



GU10 Holder



IP65



GU10 Holder

**WALL FITTING****GU10 Socket**

	<b>SKU No.</b> WL7431
	<b>Body Color</b> Black
	<b>Socket</b> GU10
	<b>Material</b> Aluminium
	<b>Dimension</b> 92x68x80 mm

	<b>SKU No.</b> WL7432
	<b>Body Color</b> White
	<b>Socket</b> GU10
	<b>Material</b> Aluminium
	<b>Dimension</b> 92x68x80 mm

	<b>SKU No.</b> WL7433
	<b>Body Color</b> Silver
	<b>Socket</b> GU10
	<b>Material</b> Aluminium
	<b>Dimension</b> 92x68x80 mm

	<b>SKU No.</b> WL7449
	<b>Body Color</b> Polished
	<b>Socket</b> GU10
	<b>Material</b> Aluminium
	<b>Dimension</b> 92x68x80 mm



IP65



GU10 Holder

**WALL FITTING****Two GU10 Sockets**

	<b>SKU No.</b> WL7437
	<b>Body Color</b> Black
	<b>Socket</b> 2 x GU10
	<b>Material</b> Aluminium
	<b>Dimension</b> 92x68x150 mm

	<b>SKU No.</b> WL7438
	<b>Body Color</b> White
	<b>Socket</b> 2 x GU10
	<b>Material</b> Aluminium
	<b>Dimension</b> 92x68x150 mm

	<b>SKU No.</b> WL7439
	<b>Body Color</b> Silver
	<b>Socket</b> 2 x GU10
	<b>Material</b> Aluminium
	<b>Dimension</b> 92x68x150 mm

	<b>SKU No.</b> WL7450
	<b>Body Color</b> Polished
	<b>Socket</b> 2 x GU10
	<b>Material</b> Aluminium
	<b>Dimension</b> 92x68x150 mm





IP65



GU10 Holder

**WALL FITTING**

GU10 Socket

- SKU No.** WL7434
- Body Color** Black
- Socket** GU10
- Material** Aluminium
- Dimension** 92x68x80 mm

- SKU No.** WL7435
- Body Color** White
- Socket** GU10
- Material** Aluminium
- Dimension** 92x68x80 mm

- SKU No.** WL7436
- Body Color** Silver
- Socket** GU10
- Material** Aluminium
- Dimension** 92x68x80 mm



IP65



GU10 Holder

**WALL FITTING**

Two GU10 Sockets

- SKU No.** WL7440
- Body Color** Black
- Socket** 2 x GU10
- Material** Aluminium
- Dimension** 92x68x150 mm

- SKU No.** WL7441
- Body Color** White
- Socket** 2 x GU10
- Material** Aluminium
- Dimension** 92x68x150 mm

- SKU No.** WL7442
- Body Color** Silver
- Socket** 2 x GU10
- Material** Aluminium
- Dimension** 92x68x150 mm

NEW









## WALL LAMP UP

E27 Holder



MATT WHITE BODY

 SKU No.	GD9301/GD9302
 Shell Color	BLACK / WHITE
 E27 Holder	MAX 60W
 Input Voltage	AC : 220-240V
 Material	Aluminium + PC
 IP Rating	IP44
 Dimension	215x170x220 mm



E27 Holder



IP44

NEW









## WALL LAMP DOWN

E27 Holder



MATT WHITE BODY

 SKU No.	GD9303/GD9304
 Shell Color	BLACK / WHITE
 E27 Holder	MAX 60W
 Input Voltage	AC : 220-240V
 Material	Aluminium + PC
 IP Rating	IP44
 Dimension	215x170x220 mm



E27 Holder



IP44

**NEW**



MATT WHITE BODY

**STAND LAMP**

E27 Holder

<b>SKU No.</b>	GD9305/GD9306
<b>Shell Color</b>	BLACK / WHITE
<b>E27 Holder</b>	MAX 60W
<b>Input Voltage</b>	AC : 220-240V
<b>Material</b>	Aluminium + PC
<b>IP Rating</b>	IP44
<b>Dimension</b>	170x170x290 mm



E27 Holder



IP44

**NEW**



MATT WHITE BODY

**CEILING LAMP**

E27 Holder

<b>SKU No.</b>	GD9307/GD9308
<b>Shell Color</b>	BLACK / WHITE
<b>E27 Holder</b>	MAX 60W
<b>Input Voltage</b>	AC : 220-240V
<b>Material</b>	Aluminium + PC
<b>IP Rating</b>	IP44
<b>Dimension</b>	170x170x740 mm



E27 Holder



IP44

NEW

**LAWN LAMP 60CM**

E27 Holder



MATT WHITE BODY

<b>SKU No.</b>	GD9309/GD9310
<b>Shell Color</b>	BLACK / WHITE
<b>E27 Holder</b>	MAX 60W
<b>Input Voltage</b>	AC : 220-240V
<b>Material</b>	Aluminium + PC
<b>IP Rating</b>	IP44
<b>Dimension</b>	175x170x600 mm



E27 Holder



IP44

NEW

**LAWN LAMP 90CM**

E27 Holder



MATT WHITE BODY

<b>SKU No.</b>	GD9311/GD9312
<b>Shell Color</b>	BLACK / WHITE
<b>E27 Holder</b>	MAX 60W
<b>Input Voltage</b>	AC : 220-240V
<b>Material</b>	Aluminium + PC
<b>IP Rating</b>	IP44
<b>Dimension</b>	170x170x900 mm



E27 Holder



IP44





MATT WHITE BODY

**POLE LAMP**

E27 Holder x2

<b>SKU No.</b>	GD9313/GD9314
<b>Shell Color</b>	BLACK / WHITE
<b>E27 Holder</b>	MAX 60Wx2
<b>Input Voltage</b>	AC : 220-240V
<b>Material</b>	Aluminium + PC
<b>IP Rating</b>	IP44
<b>Dimension</b>	528x1990 mm



E27 Holder



IP44



DARK GRAY BODY 80CM



DARK GRAY BODY 100CM

**LAWN LAMP**

E27 Holder

<b>SKU No.</b>	GD9315	GD9316
<b>Shell Color</b>	DARK GRAY	DARK GRAY
<b>E27 Holder</b>	MAX 16W	MAX 16W
<b>Input Voltage</b>	AC : 220-240V	AC : 220-240V
<b>Material</b>	Aluminium + PC	Aluminium + PC
<b>IP Rating</b>	IP54	IP54
<b>Dimension</b>	76x76x80 mm	76x76x100 mm



E27 Holder



IP54







**1W Outdoor Light**  
Buid-in Spotlight

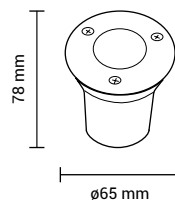

<b>SKU No.</b>	OT0507/OT0517
<b>Light Color</b>	6000K/2800K
<b>Watts</b>	1W
<b>Input Voltage</b>	AC : 200-245V
<b>Flux</b>	80lm
<b>Beam Angle</b>	18°
<b>CRI</b>	Ra>80
<b>IP Rating</b>	IP65
<b>Dimension</b>	ø65x78 mm

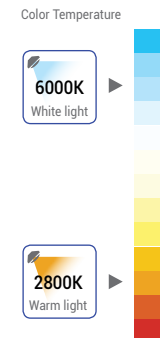

80 Lumens    
 ø58 mm    
 18°    
 IP65



**3W Outdoor Light**  
Buid-in Spotlight

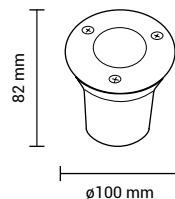

<b>SKU No.</b>	OT0501/OT0512/OT0503
<b>Light Color</b>	6000K/2800K/RGB
<b>Watts</b>	3W
<b>Input Voltage</b>	AC : 220-240V
<b>Flux</b>	240lm
<b>Beam Angle</b>	18°
<b>CRI</b>	Ra>80
<b>IP Rating</b>	IP65
<b>Dimension</b>	ø100x82 mm

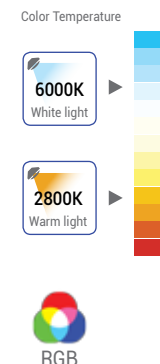

240 Lumens    
 ø90 mm    
 18°    
 IP65



**5W Outdoor Light**  
Buid-in Spotlight

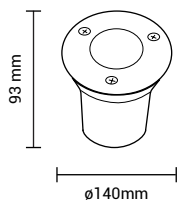

SKU No.	OT0515/OT0516
Light Color	6000K/2800K
Watts	5W
Input Voltage	AC : 220-240V
Flux	400lm
Beam Angle	18°
CRI	Ra>80
IP Rating	IP65
Dimension	ø140x93 mm

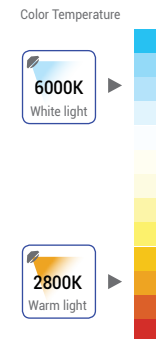

**7W Outdoor Light**  
Buid-in Spotlight

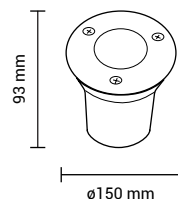

SKU No.	OT0550
Light Color	6000K
Watts	7W
Input Voltage	AC : 220-240V
Flux	560lm
Beam Angle	18°
CRI	Ra>80
IP Rating	IP65
Dimension	ø150x93 mm

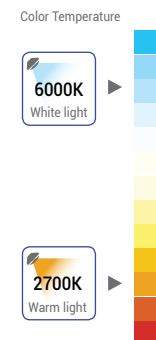



OT5051 - BLACK STRING LIGHT WITH SUSPENDED SOCKETS - 15 Pcs E27 - 14.4m  
OT5054 - BLACK STRING LIGHT WITH SUSPENDED SOCKETS - 10 Pcs E27 - 6m



OT5052 - BLACK STRING LIGHT WITH FIXED SOCKETS - 15 Pcs E27 - 14.4m



E27 Holder



IP65

## OUTDOOR STRING LIGHTS

## OUTDOOR STRING LIGHTS



OT5053 - WHITE STRING LIGHT WITH SUSPENDED SOCKETS - 15 Pcs E27 - 14.4m  
OT5055 - WHITE STRING LIGHT WITH SUSPENDED SOCKETS - 10 Pcs E27 - 6m



E27 Holder



IP65





**OT5056** - BLACK STRING LIGHT WITH COLOURFUL BULBS - 10 Pcs E27 - 8m **3W**

**OT5092** - BLACK STRING LIGHT WITH COLOURFUL BULBS - 20 Pcs E27 - 13m **6W**



**OT5090** - WHITE STRING LIGHT WITH COLOURFUL BULBS - 10 Pcs E27 - 8m **3W**

**OT5095** - WHITE STRING LIGHT WITH COLOURFUL BULBS - 20 Pcs E27 - 13m **6W**

## OUTDOOR STRING LIGHTS

## OUTDOOR STRING LIGHTS



**OT5057** - BLACK STRING LIGHT WITH BULBS 6000K - 10 Pcs E27 - 8m **3W**

**OT5058** - BLACK STRING LIGHT WITH BULBS 2700K - 10 Pcs E27 - 8m **3W**

**OT5093** - BLACK STRING LIGHT WITH BULBS 6000K - 20 Pcs E27 - 13m **6W**

**OT5094** - BLACK STRING LIGHT WITH BULBS 2700K - 20 Pcs E27 - 13m **6W**



**OT5091** - WHITE STRING LIGHT WITH BULBS 2700K - 10 Pcs E27 - 8m **3W**

**OT5096** - WHITE STRING LIGHT WITH BULBS 2700K - 20 Pcs E27 - 13m **6W**

NEW



**PIR Motion Sensor**  
White Body

<b>SKU No.</b>	SE7301	<b>Class</b>	II
<b>Input Voltage</b>	AC110-240V	<b>Time</b>	10sec-7min
<b>Beam Angle</b>	180°	<b>Max LED</b>	300W
<b>Range</b>	12m Max	<b>LUX</b>	<10Lux-2000Lux
<b>Frequency</b>	50-60 Hz	<b>Material</b>	Plastic+ALU
<b>Working Temp.</b>	-30°C/+50°C	<b>Dimension</b>	∅65x86.5mm
<b>IP</b>	IP44		

MOTION



SENSOR



180°



IP44



Power

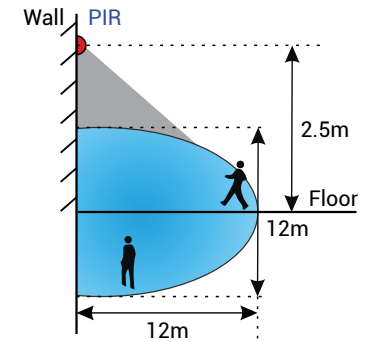

NEW



**PIR Motion Sensor**  
Black Body

<b>SKU No.</b>	SE7302	<b>Class</b>	II
<b>Input Voltage</b>	AC110-240V	<b>Time</b>	10sec-7min
<b>Beam Angle</b>	180°	<b>Max LED</b>	300W
<b>Range</b>	12m Max	<b>LUX</b>	<10Lux-2000Lux
<b>Frequency</b>	50-60 Hz	<b>Material</b>	Plastic+ALU
<b>Working Temp.</b>	-30°C/+50°C	<b>Dimension</b>	∅65x86.5mm
<b>IP</b>	IP44		

MOTION



SENSOR



180°



IP44



Power

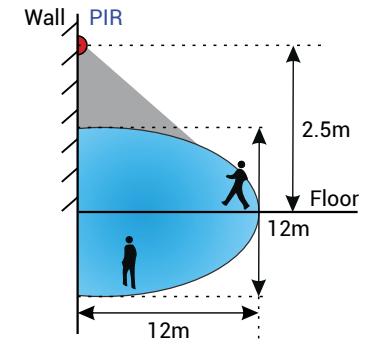

**NEW**



**PIR Motion Sensor**  
White Body

<b>SKU No.</b>	SE7306	<b>Class</b>	II
<b>Input Voltage</b>	AC110-240V	<b>Time</b>	10sec-7min
<b>Beam Angle</b>	180°	<b>Max LED</b>	200W
<b>Range</b>	12m Max	<b>LUX</b>	<10Lux-2000Lux
<b>Frequency</b>	50-60 Hz	<b>Material</b>	Plastic+ALU
<b>Working Temp.</b>	-30°C/+50°C	<b>Dimension</b>	∅77x70mm
<b>IP</b>	IP54		

MOTION



SENSOR



180°



IP54



Power

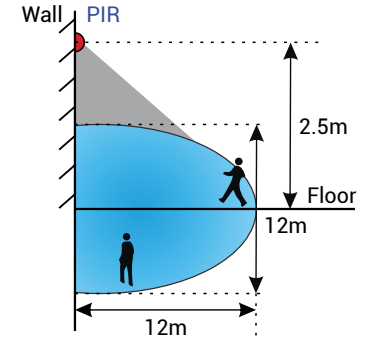

**NEW**



**PIR Motion Sensor**  
Black Body

<b>SKU No.</b>	SE7307	<b>Class</b>	II
<b>Input Voltage</b>	AC110-240V	<b>Time</b>	10sec-7min
<b>Beam Angle</b>	180°	<b>Max LED</b>	200W
<b>Range</b>	12m Max	<b>LUX</b>	<10Lux-2000Lux
<b>Frequency</b>	50-60 Hz	<b>Material</b>	Plastic+ALU
<b>Working Temp.</b>	-30°C/+50°C	<b>Dimension</b>	∅77x70mm
<b>IP</b>	IP54		

MOTION



SENSOR



180°



IP54



Power

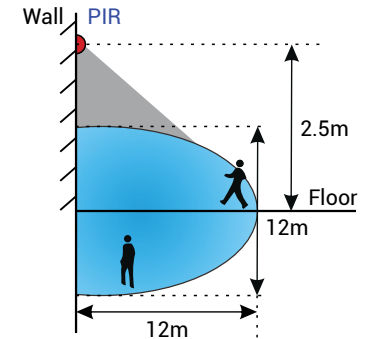

**NEW**

<b>SKU No.</b>	SE7305	<b>Class</b>	II
<b>Input Voltage</b>	AC110-240V	<b>Time</b>	10sec-7min
<b>Beam Angle</b>	360°	<b>Max LED</b>	300W
<b>Range</b>	16m Max	<b>LUX</b>	<10Lux-2000Lux
<b>Frequency</b>	50-60 Hz	<b>Material</b>	Plastic+ALU
<b>Working Temp.</b>	-30°C/+50°C	<b>Dimension</b>	∅88x55mm
<b>IP</b>	IP20		

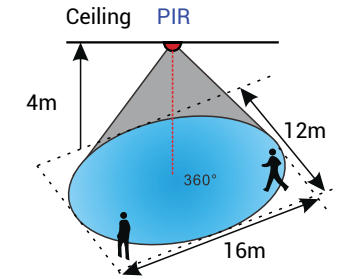
**PIR Motion Sensor**

White Body

MOTION



SENSOR



360°



IP20



Power

**NEW**

<b>SKU No.</b>	SE7308	<b>Class</b>	II
<b>Input Voltage</b>	AC110-240V	<b>Time</b>	10sec-7min
<b>Beam Angle</b>	360°	<b>Max LED</b>	300W
<b>Range</b>	6m Max	<b>LUX</b>	<10Lux-2000Lux
<b>Frequency</b>	50-60 Hz	<b>Material</b>	Plastic+ALU
<b>Working Temp.</b>	-30°C/+50°C	<b>Dimension</b>	∅76x76mm
<b>IP</b>	IP20		

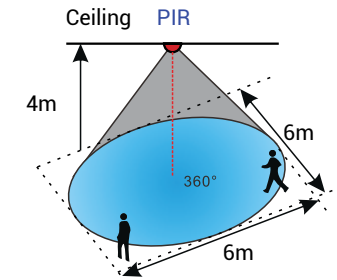
**PIR Motion Sensor**

White Body

MOTION



SENSOR



360°



IP20



Power





<b>SKU No.</b>	SE7310	<b>Class</b>	II
<b>Input Voltage</b>	AC110-240V	<b>Time</b>	10sec-7min
<b>Beam Angle</b>	360°	<b>Max LED</b>	1000W
<b>Range</b>	8m Max	<b>LUX</b>	<10Lux-2000Lux
<b>Frequency</b>	50-60 Hz	<b>Material</b>	Plastic+ALU
<b>Working Temp.</b>	-30°C/+50°C	<b>Dimension</b>	∅108x25mm
<b>IP</b>	IP20		

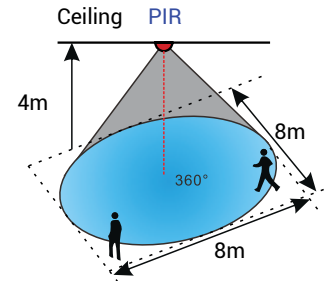

**PIR Motion Sensor**  
White Body

MOTION



<b>SKU No.</b>	SE7311	<b>Class</b>	II
<b>Input Voltage</b>	AC110-240V	<b>Time</b>	10sec-7min
<b>Beam Angle</b>	360°	<b>Max LED</b>	1000W
<b>Range</b>	8m Max	<b>LUX</b>	<10Lux-2000Lux
<b>Frequency</b>	50-60 Hz	<b>Material</b>	Plastic+ALU
<b>Working Temp.</b>	-30°C/+50°C	<b>Dimension</b>	∅65x86.5mm
<b>IP</b>	IP20		

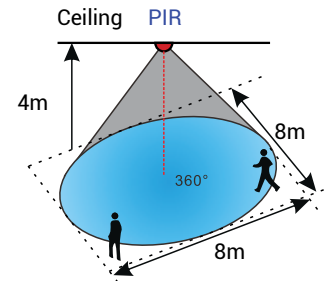

**PIR Motion Sensor**  
White Body

MOTION





<b>SKU No.</b>	SE7304	<b>Class</b>	II
<b>Input Voltage</b>	AC110-240V	<b>Time</b>	10sec-7min
<b>Beam Angle</b>	180°	<b>Max LED</b>	200W
<b>Range</b>	5cm Max	<b>LUX</b>	<10Lux-2000Lux
<b>Frequency</b>	50-60 Hz	<b>Material</b>	Plastic+ALU
<b>Working Temp.</b>	-30°C/+50°C	<b>Dimension</b>	75x18mm
<b>IP</b>	IP20		



ON/OFF via moving hand



ON/OFF via open and close

### Short Distance IR

White Body

MOTION



SENSOR



180°



IP20



Power



<b>SKU No.</b>	SE7309	<b>Class</b>	II
<b>Input Voltage</b>	AC110-240V	<b>Time</b>	10sec-7min
<b>Beam Angle</b>	120°	<b>Max LED</b>	100W
<b>Range</b>	2-10m Max	<b>LUX</b>	<10Lux-2000Lux
<b>Frequency</b>	50-60 Hz	<b>Material</b>	Plastic+ALU
<b>Working Temp.</b>	-30°C/+50°C	<b>Dimension</b>	57x35mm
<b>IP</b>	IP65		

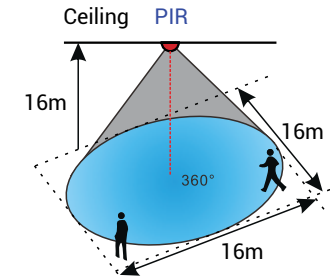

### PIR Motion Sensor

White Body

MOTION



SENSOR



120°



IP65



Power





<b>SKU No.</b>	SE7315	<b>Class</b>	II
<b>Input Voltage</b>	AC110-240V	<b>Time</b>	10sec-30min
<b>Beam Angle</b>	180°-360°	<b>Max LED</b>	300W
<b>Range</b>	25-100%	<b>LUX</b>	5,10,20,30,50,100,200Lux
<b>Frequency</b>	50-60 Hz	<b>Material</b>	Plastic+ALU
<b>Working Temp.</b>	-30°C/+50°C	<b>Dimension</b>	75x47mm
<b>IP</b>	IP20		



Dimming+Driver  
**5.8 Ghz**

**Microwave Sensor**  
White Body

MOTION



SENSOR



180-360°



IP20



Power



<b>SKU No.</b>	SL7316	<b>Class</b>	II
<b>Input Voltage</b>	AC110-240V	<b>Time</b>	10sec-7min
<b>Beam Angle</b>	180°	<b>Max LED</b>	300W
<b>Range</b>	3-10m Max	<b>LUX</b>	<10Lux-2000Lux
<b>Frequency</b>	50-60 Hz	<b>Material</b>	Plastic+ALU
<b>Working Temp.</b>	-30°C/+50°C	<b>Dimension</b>	56x42mm
<b>IP</b>	IP20		



Dimming+Driver  
**5.8 Ghz**

**Microwave Sensor**  
White Body

MOTION



SENSOR



180-360°



IP20



Power

NEW



<b>SKU No.</b>	SE7303	<b>Class</b>	II
<b>Input Voltage</b>	AC110-240V	<b>Time</b>	10sec-7min
<b>Beam Angle</b>	160°	<b>Max LED</b>	300W
<b>Range</b>	9m Max	<b>LUX</b>	<10Lux-2000Lux
<b>Frequency</b>	50-60 Hz	<b>Material</b>	Plastic+ALU
<b>Working Temp.</b>	-30°C/+50°C	<b>Dimension</b>	80x80x36mm
<b>IP</b>	IP20		

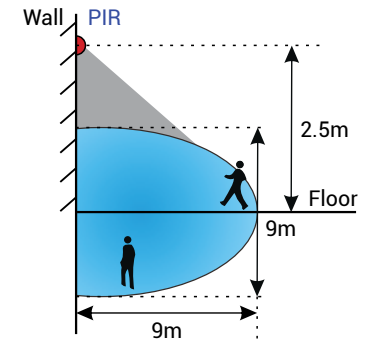

## PIR Motion Sensor

White Body

MOTION



SENSOR



160°



IP20



Power

NEW



<b>SKU No.</b>	SE7313	<b>Class</b>	II
<b>Input Voltage</b>	AC110-240V	<b>Time</b>	10sec-7min
<b>Beam Angle</b>	300°	<b>Max LED</b>	300W
<b>Range</b>	16m Max	<b>LUX</b>	<10Lux-2000Lux
<b>Frequency</b>	50-60 Hz	<b>Material</b>	Plastic+ALU
<b>Working Temp.</b>	-30°C/+50°C	<b>Dimension</b>	165x117mm
<b>IP</b>	IP44		

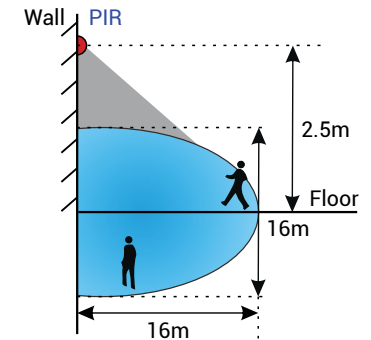

## PIR Motion Sensor

White Body

MOTION



SENSOR



300°



IP44



Power



<b>SKU No.</b>	SE7312	<b>Class</b>	II
<b>Input Voltage</b>	AC110-240V	<b>Time</b>	10sec-7min
<b>Beam Angle</b>	360°	<b>Max LED</b>	300W
<b>Range</b>	8m Max	<b>LUX</b>	<10Lux-2000Lux
<b>Frequency</b>	50-60 Hz	<b>Material</b>	Plastic+ALU
<b>Working Temp.</b>	-30°C/+50°C	<b>Dimension</b>	∅80x62mm
<b>IP</b>	IP20		

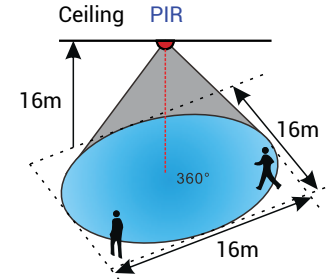

**PIR Motion Sensor**  
White Body

MOTION



<b>SKU No.</b>	SE7314	<b>Class</b>	II
<b>Input Voltage</b>	AC110-240V	<b>Lux</b>	<10Lux ON;>40Lux OFF
<b>Power</b>	6A MAX	<b>Color of the Shell</b>	WHITE + BLUE
<b>Frequency</b>	50-60 Hz	<b>Material</b>	Plastic +ALU
<b>Working Temp.</b>	-30°C/+50°C	<b>Dimension</b>	46x44x35
<b>IP</b>	IP44		



**Light Control Sensor**





A close-up, low-angle shot of an LED display panel. The grid of LEDs is illuminated with a gradient of light, transitioning from a bright cyan on the left to a deep black on the right. The perspective is slightly tilted, creating a sense of depth and movement. A dark purple horizontal bar is positioned at the bottom of the frame, containing the text 'LED DISPLAYS' in white, uppercase letters.

## LED DISPLAYS



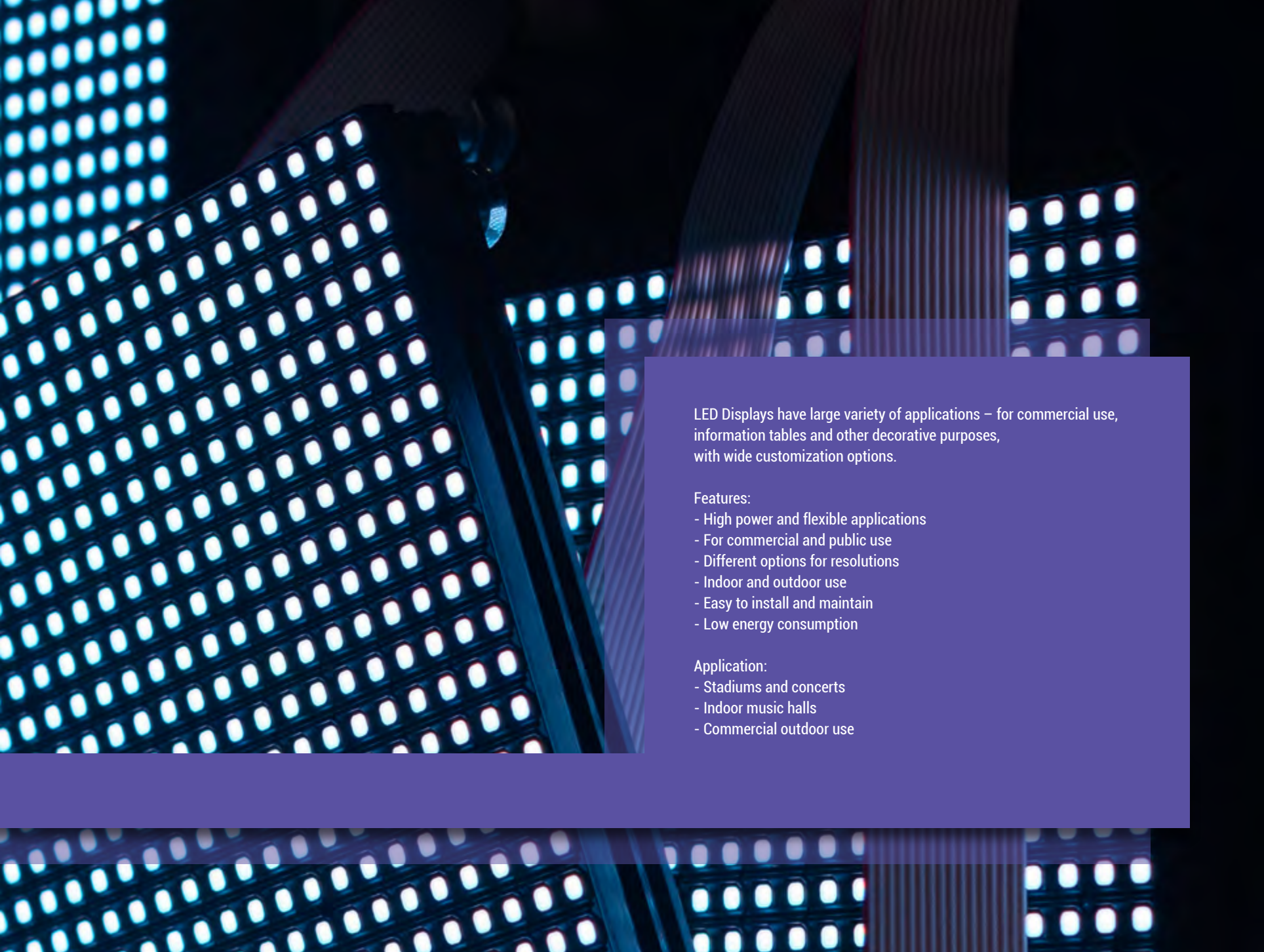

LED Displays have large variety of applications – for commercial use, information tables and other decorative purposes, with wide customization options.

Features:

- High power and flexible applications
- For commercial and public use
- Different options for resolutions
- Indoor and outdoor use
- Easy to install and maintain
- Low energy consumption

Application:

- Stadiums and concerts
- Indoor music halls
- Commercial outdoor use



NEW

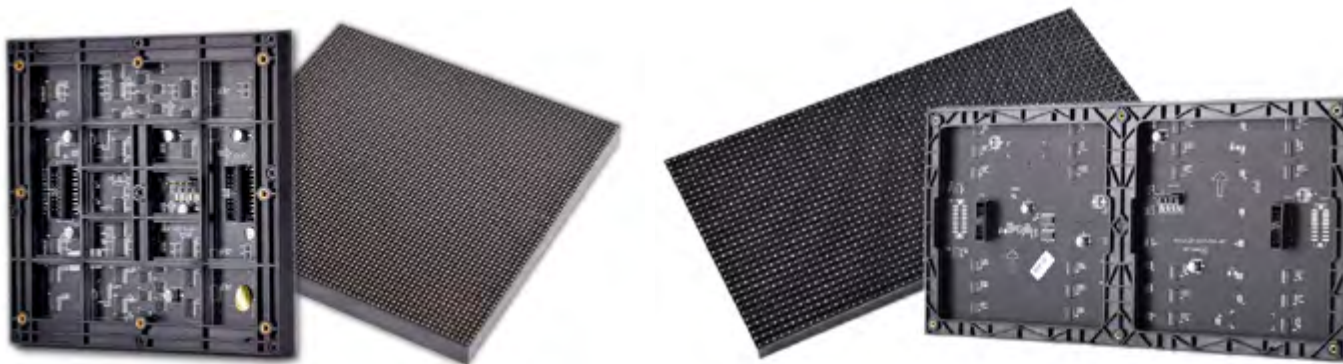

## LED DISPLAYS

## MODULE INDOOR FULL COLOR



DC 5V



150°



IP20

	P3	P4	P5
SKU No.	DS0631	DS0601	DS0602
Pixel pitch	3 mm	4 mm	5 mm
Module size	192x192mm	256x128mm	320x160mm
Module pixels	64x64 pixel	64x32 pixel	64x32 pixel
Brightness	1100 cd/m <sup>2</sup>	1100 cd/m <sup>2</sup>	1100 cd/m <sup>2</sup>
Refresh rate	1920 Hz	1920 Hz	1920 Hz
Drive mode	1/32 Scan	1/16 Scan	1/16 Scan
Module Power	16.5W	16.5W	17W
Working Temp.	-20°C/+50°C	-20°C/+50°C	-20°C/+50°C
Pixel Composition	SMD 3in1 RGB	SMD 3in1 RGB	SMD 3in1 RGB
Life Span	50 0000 h	50 0000 h	50 0000 h



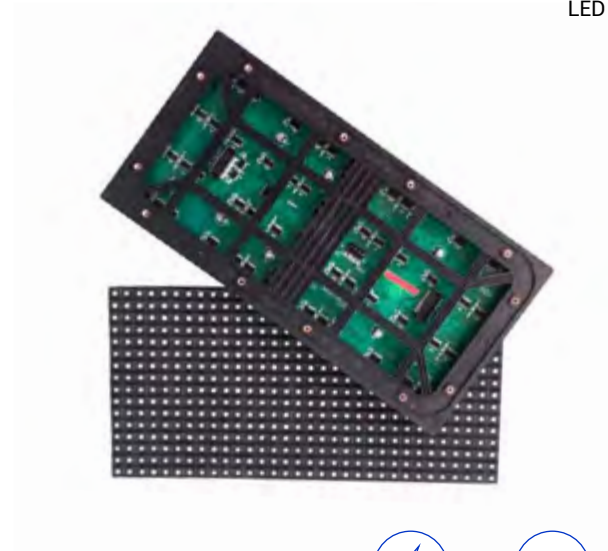
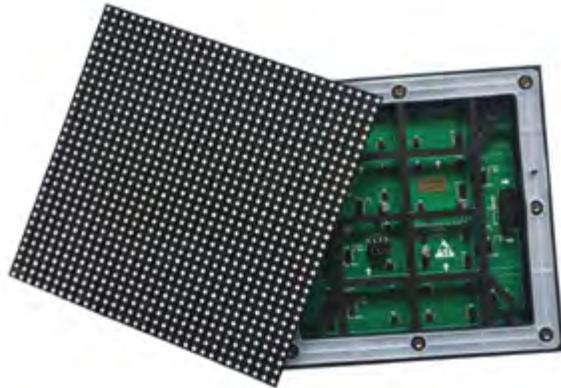

**LED DISPLAYS**

MODULE OUTDOOR FULL COLOR



DC 5V



150°



IP65

	P4	P5	P6	P8
SKU No.	DS0603	DS0604	DS0606	DS0605
Pixel pitch	4 mm	5 mm	6 mm	8 mm
Module size	256x128mm	320x160mm	196x196mm	256x128mm
Module pixels	64x32pixel	64x32 pixel	32x32 pixel	32x16 pixel
Brightness	5500 cd/m <sup>2</sup>	5500 cd/m <sup>2</sup>	5500 cd/m <sup>2</sup>	5500 cd/m <sup>2</sup>
Refresh rate	1920 Hz	1920 Hz	1920 Hz	1920 Hz
Drive mode	1/16 Scan	1/8 Scan	1/16 Scan	1/4 Scan
Module Power	35W	39W	26W	27W
Working Temp.	-20°C/+50°C	-20°C/+50°C	-20°C/+50°C	-20°C/+50°C
Pixel Composition	SMD 3in1 RGB	SMD 3in1 RGB	SMD 3in1 RGB	SMD 3in1 RGB
Life Span	50 0000 h	50 0000 h	50 0000 h	50 0000 h



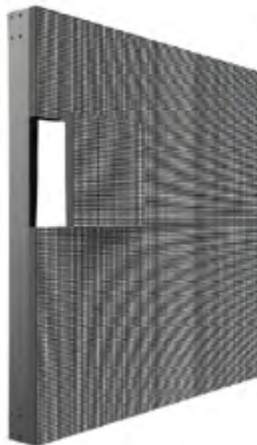

DC 5V



150°



IP20

## LED DISPLAYS Cabinet

FIX INDOOR Ver 1.0

	P3	P4	P5
SKU No.	DS0610	DS0611	DS0612
Pixel pitch	3 mm	4 mm	5 mm
Display size	960x960mm	768x768mm	960x960mm
Module size	192x192mm	256x128mm	320x160mm
Brightness	2000 cd/m <sup>2</sup>	2000 cd/m <sup>2</sup>	2000 cd/m <sup>2</sup>
Pixel Density	111 111dots/m <sup>2</sup>	62 500dots/m <sup>2</sup>	40 000dots/m <sup>2</sup>
Drive mode	1/32 Scan	1/16 Scan	1/16 Scan
Refresh rate	1920 Hz	1920 Hz	1920 Hz
Working Temp.	-20°C/+50°C	-20°C/+50°C	-20°C/+50°C
MAX Power	750W	750W	750W
Life Span	50 0000 h	50 0000 h	50 0000 h

## LED DISPLAYS Cabinet

FIX INDOOR Ver 2.0

	P3	P4	P5
SKU No.	DS0638	DS0639	DS0640
Pixel pitch	3 mm	4 mm	5 mm
Display size	960x960mm	768x768mm	960x960mm
Module size	192x192mm	256x128mm	320x160mm
Brightness	2000 cd/m <sup>2</sup>	2000 cd/m <sup>2</sup>	2000 cd/m <sup>2</sup>
Pixel Density	111 111dots/m <sup>2</sup>	62 500dots/m <sup>2</sup>	40 000dots/m <sup>2</sup>
Drive mode	1/32 Scan	1/16 Scan	1/16 Scan
Refresh rate	1920 Hz	1920 Hz	1920 Hz
Working Temp.	-20°C/+50°C	-20°C/+50°C	-20°C/+50°C
MAX Power	750W	750W	750W
Life Span	50 0000 h	50 0000 h	50 0000 h





DC 5V



150°



IP65

## LED DISPLAYS Cabinet

**FIX OUTDOOR**

	P4	P5	P8
SKU No.	DS0617	DS0618	DS0619
Pixel pitch	4 mm	5 mm	8 mm
Display size	768x768mm	960x960mm	768x768mm
Module size	256x128mm	160x160 pixel	256x128mm
Brightness	5500 cd/m <sup>2</sup>	5500 cd/m <sup>2</sup>	5500 cd/m <sup>2</sup>
Pixel Density	62 500dots/m <sup>2</sup>	40 000dots/m <sup>2</sup>	15 625dots/m <sup>2</sup>
Drive mode	1/8 Scan	1/8 Scan	1/8 Scan
Refresh rate	1920 Hz	1920 Hz	1920 Hz
Working Temp.	-20°C/+50°C	-20°C/+50°C	-20°C/+50°C
MAX Power	800W	800W	800W
Life Span	50 0000 h	50 0000 h	50 0000 h



**NEW****LED DISPLAYS****RENTAL INDOOR P2.5;P4;P5**

DC 5V



150°



IP20

	P2.5	P4	P5
SKU No.	DS0620	DS0613	DS0614
Pixel pitch	2.5 mm	4 mm	5 mm
Display size	640x640mm	768x768mm	960x960mm
Module size	160x160mm	256x128mm	320x160mm
Brightness	2000 cd/m <sup>2</sup>	2000 cd/m <sup>2</sup>	2000 cd/m <sup>2</sup>
Pixel Density	160 000dots/m <sup>2</sup>	62 500dots/m <sup>2</sup>	40 000dots/m <sup>2</sup>
Drive mode	1/16 Scan	1/16 Scan	1/16 Scan
Port type	HUB75	HUB75	HUB75
Working Temp.	-20°C/+50°C	-20°C/+50°C	-20°C/+50°C
MAX Power	600W	600W	750W
Life Span	50 0000 h	50 0000 h	50 0000 h

**LED DISPLAYS****RENTAL OUTDOOR P4;P5**

DC 5V



150°



IP65

	P4	P5
SKU No.	DS0615	DS0616
Pixel pitch	4 mm	5 mm
Display size	768x768mm	960x960mm
Module size	256x128mm	320x160mm
Brightness	7500 cd/m <sup>2</sup>	7500 cd/m <sup>2</sup>
Pixel Density	62 500dots/m <sup>2</sup>	40 000dots/m <sup>2</sup>
Drive mode	1/8 Scan	1/8 Scan
Port type	HUB75	HUB75
Working Temp.	-20°C/+50°C	-20°C/+50°C
MAX Power	600W	750W
Life Span	50 0000 h	50 0000 h







DC 5V



150°



IP65

**LED DISPLAYS**

**OUTDOOR STADIUM SCREEN**

	<b>P5</b>	<b>P10</b>
SKU No.	DS0665	DS0622
Pixel pitch	5 mm	10 mm
Module size	320x160mm	320x160mm
Module pixels	64x32 pixel	32x16 pixel
Brightness	7500 cd/m <sup>2</sup>	7500 cd/m <sup>2</sup>
Pixel Density	40 000dots/m <sup>2</sup>	10 000dots/m <sup>2</sup>
Drive mode	1/8 Scan	1/4 Scan
Port type	HUB75	HUB75
Working Temp.	-20°C/+50°C	-20°C/+50°C
MAX Power	700W	700W
Life Span	50 0000 h	50 0000 h



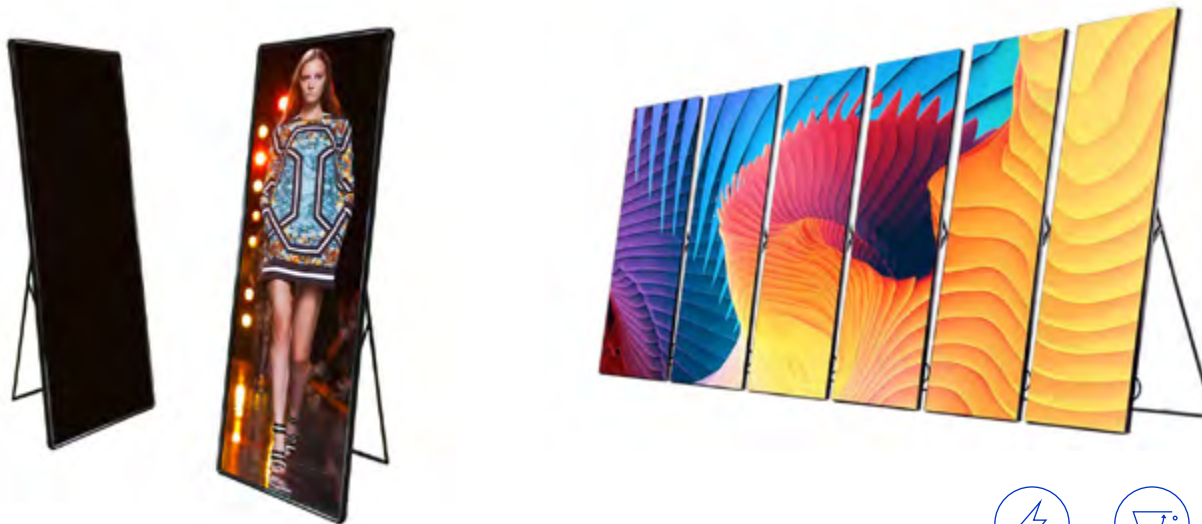

**LED DISPLAYS**  
INDOOR POSTER DISPLAY



	P2.5	P3	P4
SKU No.	DS0663	DS0621	DS0664
Pixel pitch	2.5 mm	3 mm	4 mm
Module size	320x160mm	192x192mm	256x128mm
Module pixels	128x64 pixel	64x64 pixel	64x32 pixel
Brightness	2000 cd/m <sup>2</sup>	2000 cd/m <sup>2</sup>	2000 cd/m <sup>2</sup>
Pixel Density	160 000dots/ m <sup>2</sup>	111 111dots/ m <sup>2</sup>	62 500dots/ m <sup>2</sup>
Drive mode	1/32 Scan	1/32 Scan	1/16 Scan
Port type	HUB75	HUB75	HUB75
Working Temp.	-20°C/+50°C	-20°C/+50°C	-20°C/+50°C
Pixel Composition	SMD 3in1 RGB	SMD 3in1 RGB	SMD 3in1 RGB
Life Span	100000 h	100000 h	100000 h







**LED DISPLAYS**

**OUTDOOR & INDOOR STAGE FLOOR**



	<b>P3.91</b>	<b>P4.81</b>	<b>P5.95</b>
SKU No.	DS0660	DS0661	DS0662
Pixel pitch	3.91 mm	4.81 mm	5.95mm
Module size	250x250mm	250x250mm	250x250mm
Module pixels	64x64 pixel	52x52 pixel	42x42 pixel
Brightness	7500 cd/m <sup>2</sup>	7500 cd/m <sup>2</sup>	7500 cd/m <sup>2</sup>
Pixel Density	65 536dots/m <sup>2</sup>	43 264dots/m <sup>2</sup>	28 224dots/m <sup>2</sup>
Drive mode	1/8 Scan	1/13 Scan	1/8 Scan
Port type	HUB75	HUB75	HUB75
Working Temp.	-20°C/+50°C	-20°C/+50°C	-20°C/+50°C
MAX Power	700W	700W	700W
Life Span	50 0000 h	50 0000 h	50 0000 h

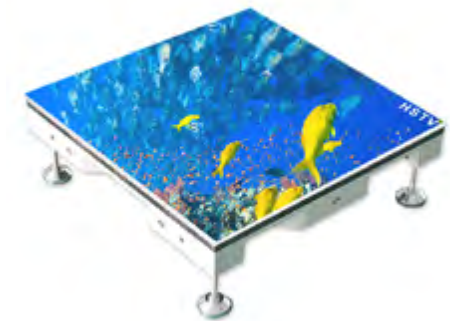



**SENDING CARD**  
FOR LED DISPLAYS

**SKU No.**  
**Input Resolution**  
**Capacity**  
**Supply Voltage**  
**Control Method**  
**Video Interface**  
**Audio Interface**  
**Video Format**  
**Output Interface**  
**Bit Depth Of Video Resource**

DS0650	1280×1024,1024×1200,1600×848	1.3 million pixels	5V	USB Interface	DVI	3.5mm	RGB	2 Ethernet ports	8bit
--------	------------------------------	--------------------	----	---------------	-----	-------	-----	------------------	------

DS0651	1920×1200,2048×1152,2560×96	2.3 million pixels	5V	USB Interface	HDMI/DVI	HDMI/3.5mm	RGB ,YCrCb4:2:2,YCrCb4:4:4	4 Ethernet ports	8/10/12bit
--------	-----------------------------	--------------------	----	---------------	----------	------------	----------------------------	------------------	------------



**RECEIVING CARD**  
FOR LED DISPLAYS

**SKU No.**  
**Resolution**  
**RGB Data Output**  
**Interface**

DS0652	DS0653	DS0654	DS0655
512 x 256	256 x 226	256 x 226	512x256
32 Groups	24 Groups	24 Groups	32 Groups
16 x HUB75	8 x HUB75	12 x HUB75	16 x HUB75





<b>SKU No.</b>	DS0656
<b>Product Type :</b>	Video Controller
<b>Inputs :</b>	HDMI, DVI, VGA × 2, CVBS × 2, DP, SDI
<b>Outputs :</b>	Ethernet port × 4
<b>Loading Capacity :</b>	2.35 million pixels
<b>Maximum pixel CLK</b>	165MHz
<b>Video Loop :</b>	DVI LOOP, SDI LOOP
<b>Video Monitor :</b>	VGA OUT, DVI OUT
<b>Communication Mode:</b>	USB/LAN
<b>Image Mosaic :</b>	Support
<b>Crop Settings :</b>	Support
<b>PIP :</b>	Support

**ALL-IN-1 CONTROLLER**  
LED VIDEO PROCESSOR WITH SDI



**ACCESSORIES**  
FOR LED DISPLAYS



**Power Supplies**  
Metal 5V output











DC 5V



IP20



 <b>SKU No.</b>	AC6191	AC6192
 <b>Watts</b>	200W	300W
 <b>Input Voltage</b>	220V	220V
 <b>Output Voltage</b>	DC:5V	DC:5V
 <b>Current</b>	40A	60A
 <b>Material</b>	Metal	Metal
 <b>IP Rating</b>	IP20	IP20
 <b>Dimension</b>	190x80x30 mm	190x80x30 mm



SKU	Page No.	SKU	Page No.	SKU	Page No.	SKU	Page No.	SKU	Page No.	SKU	Page No.	SKU	Page No.	SKU	Page No.	SKU	Page No.	SKU	Page No.	SKU	Page No.		
0220	195	0640	246	1267	35	1471	19	1536	30	1729	3	1763	32	1832	4	1865	17	1902	24	1952	25	2255	65
0221	195	0650	252	1268	35	1472	19	1541	29	1730	3	1764	32	1833	4	1866	17	1903	24	1953	25	2256	65
0222	86	0651	252	1269	35	1473	19	1542	29	1731	3	1765	32	1834	5	1867	17	1904	24	1954	25	2257	65
0501	230	0652	252	1270	35	1474	19	1543	29	1732	3	1766	32	1835	4	1868	17	1905	24	1955	25	2258	65
0503	203	0653	252	1271	35	1475	19	1615	26	1733	3	1767	36	1836	4	1869	17	1906	24	1956	25	2261	65
0507	230	0654	252	1272	35	1476	19	1616	26	1734	3	1768	36	1837	4	1872	18	1907	24	1957	34	2262	70
0512	230	0655	252	1273	35	1477	19	1617	26	1735	3	1769	36	1838	7	1873	16	1908	24	1958	34	2263	70
0515	231	0656	253	1274	35	1478	19	1618	28	1736	7	1770	36	1839	7	1874	16	1909	24	1959	34	2264	70
0516	231	0660	251	1438	21	1479	19	1619	28	1737	7	1771	36	1840	7	1875	16	1910	25	1960	34	2265	70
0517	230	0661	251	1439	21	1480	18	1620	28	1738	7	1772	36	1841	6	1876	9	1911	24	1961	34	2266	70
0550	231	0662	251	1440	21	1481	18	1635	27	1739	7	1773	36	1842	6	1877	9	1912	24	1962	34	2270	67
0601	244	0663	250	1447	21	1482	18	1636	27	1740	7	1780	20	1843	6	1878	9	1913	24	1963	34	2271	67
0602	244	0664	250	1448	21	1487	21	1637	27	1741	7	1781	20	1844	5	1879	14	1914	25	1964	34	2272	67
0603	245	0665	249	1449	21	1488	21	1638	27	1742	6	1782	20	1845	6	1880	14	1915	24	1965	34	2273	67
0604	245	1066	26	1451	21	1489	21	1639	27	1743	6	1790	10	1846	6	1881	4	1916	24	2231	64	2274	67
0605	245	1067	26	1452	21	1490	15	1640	27	1744	6	1791	10	1847	6	1882	4	1917	24	2232	64	2275	67
0606	245	1068	26	1453	21	1491	15	1641	28	1745	6	1792	10	1848	5	1883	4	1929	37	2235	64	2279	70
0610	246	1163	33	1454	22	1492	15	1642	28	1746	6	1793	10	1849	5	1884	6	1930	37	2236	64	2280	66
0611	246	1164	33	1455	22	1516	31	1643	28	1747	6	1794	11	1850	5	1885	6	1931	37	2237	65	2281	66
0612	246	1167	33	1456	22	1517	31	1715	2	1748	2	1795	11	1851	5	1886	6	1932	37	2238	65	2283	66
0613	248	1168	33	1457	22	1518	31	1716	2	1749	2	1796	11	1852	5	1887	14	1933	37	2241	65	2284	66
0614	248	1169	33	1458	22	1519	31	1717	2	1750	2	1816	7	1853	16	1888	14	1934	37	2242	65	2285	66
0615	248	1170	33	1459	22	1520	9	1718	2	1751	20	1817	7	1854	16	1889	14	1935	37	2243	64	2286	66
0616	248	1191	32	1460	22	1521	9	1719	2	1752	20	1818	7	1855	16	1890	14	1936	37	2244	64	2287	66
0617	247	1192	32	1461	22	1522	9	1720	2	1753	20	1819	23	1856	16	1891	8	1937	37	2246	64	2288	66
0618	247	1193	32	1462	22	1523	29	1721	2	1754	20	1824	4	1857	16	1892	8	1938	37	2247	64	2289	71
0619	247	1194	32	1463	22	1524	29	1722	2	1755	20	1825	4	1858	16	1893	14	1939	37	2248	64	2290	72
0620	248	1195	32	1464	22	1525	29	1723	2	1756	20	1826	4	1859	16	1894	8	1940	37	2249	64	2291	72
0621	250	1196	32	1465	22	1531	30	1724	2	1757	20	1827	4	1860	17	1895	8	1945	37	2250	64	2292	73
0622	249	1263	35	1466	23	1532	30	1725	2	1758	20	1828	4	1861	17	1896	14	1946	37	2251	65	2293	73
0631	244	1264	35	1467	23	1533	30	1726	2	1759	20	1829	4	1862	17	1897	8	1947	37	2252	65	2294	74
0638	246	1265	35	1468	23	1534	30	1727	3	1761	32	1830	5	1863	17	1898	8	1950	25	2253	65	2295	74
0639	246	1266	35	1470	19	1535	30	1728	3	1762	32	1831	4	1864	17	1901	24	1951	25	2254	65	2296	216

SKU	Page No.	SKU	Page No.	SKU	Page No.	SKU	Page No.	SKU	Page No.	SKU	Page No.	SKU	Page No.	SKU	Page No.	SKU	Page No.		
2297	77	2441	104	2528	59	2568	99	2627	102	2723	90	2818	68	3268	113	4421	136	4514	145
2298	75	2442	104	2529	59	2569	99	2628	102	2724	90	3201	114	3269	113	4422	136	4515	145
2299	75	2443	104	2530	59	2570	99	2629	102	2725	90	3202	114	3270	118	4423	136	4516	145
2335	104	2444	105	2531	59	2571	99	2633	103	2726	90	3203	114	3271	118	4424	134	4521	145
2336	104	2445	105	2532	59	2572	99	2634	103	2727	90	3204	114	3272	118	4425	134	4522	145
2348	105	2446	105	2533	59	2573	99	2635	103	2728	90	3205	114	3273	118	4426	134	4523	145
2349	105	2447	105	2534	59	2574	99	2636	103	2731	90	3206	114	3274	118	4431	137	4524	145
2350	92	2448	105	2535	60	2575	99	2637	103	2732	90	3207	115	3275	118	4432	137	4525	145
2351	92	2449	105	2536	60	2576	99	2638	103	2733	90	3212	115	3276	118	4433	137	4526	145
2356	93	2450	105	2537	60	2577	99	2639	103	2734	94	3222	115	3277	118	4441	133	4531	146
2357	93	2451	105	2538	60	2578	99	2640	103	2735	94	3223	115	3278	118	4451	136	4532	146
2358	93	2452	105	2539	61	2579	99	2641	103	2736	94	3224	115	3284	112	4452	136	4533	146
2363	92	2453	105	2540	61	2581	106	2645	62	2740	91	3225	115	3285	112	4453	136	4534	146
2367	92	2454	105	2541	61	2582	106	2646	62	2741	91	3241	117	3286	112	4454	134	4535	146
2368	92	2455	105	2542	61	2583	106	2647	62	2744	91	3242	117	3287	113	4455	134	4536	147
2369	92	2456	105	2550	98	2584	106	2648	62	2745	91	3243	117	3288	113	4456	134	4541	144
2372	94	2511	58	2551	98	2585	106	2649	62	2801	69	3244	117	3289	112	4461	137	4542	144
2373	94	2512	58	2552	98	2586	108	2650	62	2802	69	3251	116	3290	112	4462	137	4543	144
2374	94	2513	58	2553	98	2587	108	2651	62	2803	69	3252	116	3291	112	4463	137	4544	144
2375	93	2514	58	2554	98	2590	100	2652	62	2804	69	3253	116	3292	112	4471	133	4545	144
2376	93	2515	58	2555	98	2591	100	2653	62	2805	69	3254	116	3293	113	4481	138	4546	144
2377	93	2516	58	2556	98	2592	100	2657	63	2806	69	3255	116	3294	113	4482	138	4551	144
2431	104	2517	58	2557	98	2593	100	2658	63	2807	68	3256	116	3295	113	4483	138	4552	144
2432	104	2518	58	2558	98	2594	101	2659	63	2808	68	3257	109	4311	126	4485	135	4553	144
2432	104	2519	58	2559	98	2595	101	2660	63	2809	68	3258	109	4312	126	4486	135	4554	144
2433	104	2520	58	2560	98	2596	101	2661	63	2810	68	3260	119	4313	125	4487	135	4555	144
2434	104	2521	58	2561	98	2597	101	2662	63	2811	68	3261	119	4314	125	4488	135	4561	146
2435	104	2522	58	2562	98	2621	102	2663	63	2812	68	3262	119	4315	126	4490	140	4562	146
2436	104	2523	59	2563	8	2622	102	2664	63	2813	68	3263	119	4316	126	4491	140	4580	143
2437	104	2524	59	2564	98	2623	102	2665	63	2814	68	3264	112	4403	139	4492	140	4581	143
2438	104	2525	59	2565	99	2624	102	2720	90	2815	68	3265	112	4404	139	4511	145	4582	143
2439	104	2526	59	2566	99	2625	102	2721	90	2816	68	3266	112	4405	139	4512	145	4583	143
2440	104	2527	59	2567	99	2626	102	2722	90	2817	68	3267	113	4406	139	4513	145	4584	143



SKU	Page No.	SKU	Page No.	SKU	Page No.	SKU	Page No.	SKU	Page No.	SKU	Page No.	SKU	Page No.	SKU	Page No.	SKU	Page No.	SKU	Page No.	SKU	Page No.		
4585	143	4811	130	5011	173	5058	233	5118	170	5210	183	5443	182	5528	44	5669	45	5827	187	5868	178	6029	96
4586	143	4823	129	5012	173	5060	41	5120	170	5212	183	5445	182	5529	44	5786	180	5828	187	5869	178	6031	95
4587	143	4825	129	5013	173	5061	41	5126	170	5233	183	5446	182	5530	44	5787	180	5829	187	5870	178	6032	95
4588	143	4827	129	5014	173	5062	41	5127	170	5275	176	5447	182	5531	44	5788	180	5830	187	5871	178	6101	152
4589	143	4829	130	5015	173	5063	41	5128	171	5276	176	5448	182	5532	44	5789	180	5831	187	5872	178	6102	152
4611	142	4840	130	5016	173	5064	41	5130	171	5277	176	5449	182	5533	44	5790	180	5832	187	5873	178	6103	152
4612	142	4850	132	5017	173	5065	41	5135	171	5278	176	5460	177	5534	44	5791	180	5833	187	5874	178	6104	154
4700	124	4851	132	5018	173	5066	41	5136	171	5279	176	5461	177	5535	44	5792	181	5836	187	5875	178	6105	154
4702	124	4852	132	5019	173	5067	41	5137	171	5280	176	5462	177	5601	48	5793	181	5837	187	5876	178	6106	154
4704	124	4853	133	5020	173	5068	41	5138	171	5281	176	5463	177	5602	48	5794	181	5841	184	5877	178	6108	154
4705	124	4854	133	5021	173	5070	38	5149	170	5321	168	5472	188	5603	48	5795	181	5842	184	5878	178	6109	154
4706	124	4855	133	5022	173	5071	38	5151	165	5322	168	5473	188	5604	48	5796	181	5843	184	5879	178	6110	153
4710	124	4856	132	5023	173	5072	38	5152	165	5323	168	5474	188	5605	48	5797	181	5844	184	5880	179	6111	153
4711	124	4857	132	5024	173	5073	38	5153	172	5324	168	5475	188	5606	48	5801	186	5845	184	5881	179	6112	153
4720	128	4858	132	5025	173	5074	38	5154	172	5325	168	5476	188	5607	48	5802	186	5846	184	5882	179	6114	154
4721	128	4861	127	5026	173	5075	38	5155	172	5326	168	5477	188	5608	48	5803	186	5847	184	5883	179	6115	153
4731	128	4862	127	5031	167	5076	39	5156	172	5327	168	5511	47	5609	48	5804	186	5848	184	5884	179	6117	154
4732	128	4901	131	5032	167	5077	39	5157	172	5328	168	5512	47	5610	48	5805	186	5849	184	5885	179	6119	152
4733	128	4902	131	5033	167	5078	39	5158	172	5329	168	5512	47	5611	48	5806	186	5851	184	5886	179	6120	152
4734	128	4903	131	5034	167	5081	40	5159	172	5330	169	5513	47	5645	45	5807	186	5853	185	5887	179	6121	154
4735	128	4911	131	5035	167	5082	40	5160	172	5331	169	5514	47	5646	45	5808	138	5854	185	5888	179	6124	154
4736	128	4912	131	5041	121	5083	40	5179	147	5332	169	5515	47	5647	45	5809	138	5855	185	5889	179	6131	156
4740	124	4913	131	5042	121	5084	40	5182	96	5371	166	5516	47	5648	45	5810	186	5856	185	5890	179	6132	156
4761	125	5001	147	5044	120	5085	40	5188	96	5372	166	5517	47	5649	45	5811	186	5857	185	5891	179	6133	156
4762	125	5002	147	5045	120	5086	40	5190	147	5373	166	5518	47	5650	45	5812	186	5858	185	5892	179	6134	156
4763	125	5003	107	5046	120	5090	233	5191	147	5374	166	5519	47	5651	45	5816	186	5859	185	5893	179	6135	156
4800	129	5004	107	5051	232	5091	233	5192	147	5375	166	5521	44	5652	45	5817	186	5860	185	5894	179	6140	164
4801	129	5005	107	5052	232	5092	233	5193	147	5376	166	5522	44	5654	45	5821	187	5861	185	6013	95	6141	164
4802	129	5006	107	5053	232	5093	233	5194	147	5377	167	5523	44	5656	45	5822	187	5862	185	6024	95	6151	155
4807	129	5007	173	5054	232	5094	233	5195	97	5406	189	5524	44	5657	45	5823	187	5863	185	6025	107	6152	155
4808	129	5008	173	5055	232	5095	233	5196	97	5407	189	5525	44	5658	45	5824	187	5865	178	6026	107	6153	155
4809	130	5009	173	5056	233	5096	233	5197	97	5429	182	5526	44	5663	45	5825	187	5866	178	6027	107	6154	155
4810	130	5010	173	5057	233	5117	170	5198	97	5430	182	5527	44	5665	45	5826	187	5867	178	6028	95	6155	155



SKU	Page No.	SKU	Page No.	SKU	Page No.	SKU	Page No.	SKU	Page No.	SKU	Page No.	SKU	Page No.	SKU	Page No.	SKU	Page No.	SKU	Page No.	SKU	Page No.		
6161	157	6264	151	6354	163	6668	51	7136	205	7422	222	7462	212	7495	214	7532	210	9006	82	9044	87	9312	228
6162	157	6302	158	6363	163	6669	51	7201	56	7423	222	7463	213	7496	214	7533	210	9007	82	9045	87	9313	228
6163	157	6303	158	6608	165	6670	51	7202	56	7431	224	7464	213	7497	214	7534	210	9008	82	9135	192	9314	229
6164	157	6304	158	6610	165	6671	51	7203	55	7432	224	7465	213	7498	214	7535	210	9009	82	9136	192	9315	229
6165	157	6305	159	6611	165	6672	52	7204	55	7433	224	7466	213	7503	218	8122	198	9010	82	9137	193	9316	229
6191	253	6306	158	6612	165	6673	52	7205	55	7434	225	7467	213	7504	218	8123	198	9011	82	9138	193	2367-S	92
6192	253	6307	158	6613	165	6674	52	7206	55	7435	225	7468	213	7505	218	8124	199	9012	82	9156	200	2368-S	92
6201	148	6308	160	6614	165	6675	52	7207	56	7436	225	7469	213	7506	218	8125	199	9013	83	9157	200	2369-S	92
6202	148	6310	159	6615	165	6676	52	7208	57	7437	224	7470	211	7507	218	8126	194	9014	83	9158	200	5170-N	39
6203	148	6311	159	6616	165	6677	52	7209	57	7438	224	7471	211	7508	218	8127	199	9015	83	9171	200	5171-N	39
6206	148	6312	160	6617	165	6678	52	7210	57	7439	224	7472	211	7509	219	8140	194	9016	83	9172	201	5172-N	39
6207	148	6314	160	6618	165	6679	52	7211	57	7440	225	7473	211	7510	219	8141	194	9017	84	9173	201	5611-M	46
6211	149	6315	160	6619	165	6680	52	7301	234	7441	225	7474	211	7511	219	8142	196	9018	84	9174	201	5612-M	46
6212	149	6317	161	6620	165	6681	52	7302	234	7442	225	7475	215	7512	219	8143	196	9019	84	9175	203	5613-M	46
6213	149	6318	161	6621	165	6682	52	7303	240	7443	223	7476	215	7513	219	8144	196	9020	84	9176	203	5623-M	46
6214	149	6319	161	6631	142	6691	53	7304	238	7444	223	7477	215	7514	219	8145	196	9021	84	9177	203	5624-M	46
6221	149	6320	161	6632	142	6692	53	7305	236	7445	223	7478	215	7515	220	8146	196	9022	85	9178	203	5625-M	46
6222	149	6326	159	6633	142	6694	53	7306	235	7446	223	7479	215	7516	220	8147	196	9023	85	9181	202	5641-M	46
6223	149	6328	159	6650	49	6695	53	7307	235	7447	223	7480	215	7517	220	8148	196	9024	85	9182	202	5642-M	46
6224	149	6329	160	6651	49	6697	53	7308	236	7448	223	7481	215	7518	220	8149	196	9025	85	9183	202	5643-M	46
6231	150	6331	141	6652	49	6698	53	7309	238	7449	224	7482	215	7519	220	8151	197	9026	85	9184	202	9171-S	201
6232	150	6332	141	6653	49	7116	205	7310	237	7450	224	7483	215	7520	220	8152	197	9031	78	9185	202		
6233	150	6342	163	6654	49	7121	207	7311	237	7451	212	7484	215	7521	217	8153	197	9032	78	9301	226		
6241	150	6343	163	6655	49	7122	207	7312	241	7452	212	7485	215	7522	221	8154	197	9033	79	9302	226		
6242	150	6344	164	6659	51	7123	207	7313	240	7453	212	7486	214	7523	221	8156	197	9034	79	9303	226		
6243	150	6345	164	6660	51	7126	206	7314	241	7454	212	7487	214	7524	221	8157	197	9035	77	9304	226		
6251	151	6346	164	6661	50	7127	206	7315	239	7455	212	7488	214	7525	221	8158	197	9036	76	9305	227		
6252	151	6347	164	6662	50	7128	206	7316	239	7456	212	7489	214	7526	216	9000	80	9037	76	9306	227		
6253	151	6348	162	6663	50	7131	204	7401	222	7457	212	7490	214	7527	216	9001	80	9038	76	9307	227		
6254	151	6349	162	6664	50	7132	204	7402	222	7458	212	7491	214	7528	210	9002	80	9039	76	9308	227		
6261	151	6350	164	6665	51	7133	205	7403	217	7459	212	7492	214	7529	210	9003	80	9041	86	9309	228		
6262	151	6351	162	6666	51	7134	204	7404	217	7460	212	7493	214	7530	210	9004	81	9042	86	9310	228		
6263	151	6352	162	6667	51	7135	204	7421	222	7461	212	7494	214	7531	210	9005	81	9043	87	9311	228		



**OVER  
1000  
PRODUCTS**



**5  
Year  
Warranty**

