



Profile aluminiu pentru bandă LED

Profile de suprafață | Profile încastrate | Profile de colț
Profile speciale | Profile pentru sticlă

LED profiles



LED profiles

Tutorial 1.01



Forthcoming products 1.17



surface LED profiles

SLIM8 A/Z	2.01
SMART10 A/Z	2.05
SURFACE10 BC/UX	2.09
BEGTON12 J/S	2.13
UNI12 BCD/U	2.17
SURFACE14 EF/TY	2.21
SMART16 B/U4	2.25
LINEA20 EF/TY	2.29
WIDE24 G/W	2.41

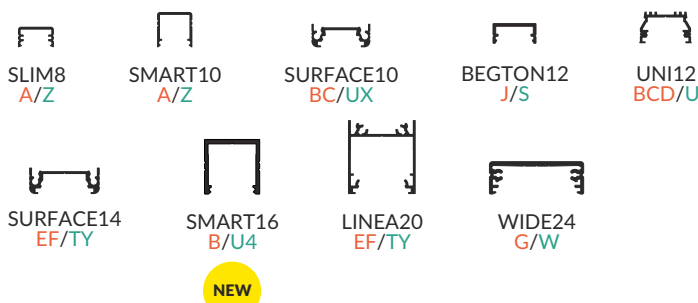

recessed LED profiles

FLAT8 H/UX	3.01
HI8 C1	3.05
DEEP10 BC/UX	3.09
GROOVE10 BC/UX	3.13
SMART-IN10 A/Z	3.17
BEGTIN12 J/S	3.21
FLOOR12 K/U	3.25
GROOVE14 EF/TY	3.29
SMART-IN16 B/U4	3.33
LINEA-IN20 EF/U7	3.37

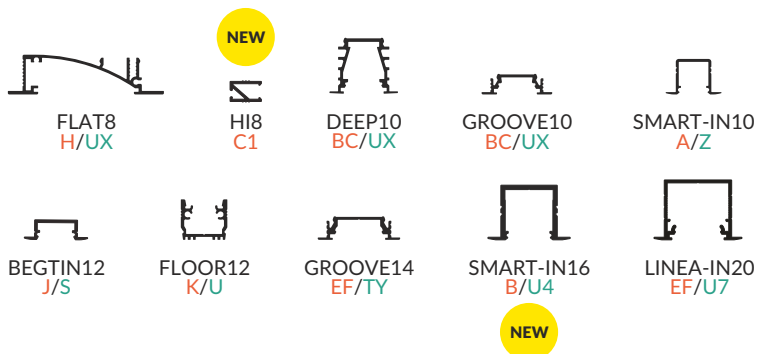

corner LED profiles

TRIO10 BC	4.01
CORNER10 BC/UX	4.05
QUARTER10 BD/U6	4.09
CABI12 E	4.13
CORNER14 EF/TY	4.17
CORNER27 G/UX	4.21



special application LED profiles

PEN8 I	5.01
BACK10 A/UX	5.05
STEP10 C	5.09
AMBI12 C	5.13
ARC12 CD/U5	5.17
FIX12 / FIX16	5.21
OUTSTAIRS12 BC	5.23
WALLE12 BCD	5.27
FRAME14 BC/Q	5.31
OVAL20 BC	5.35

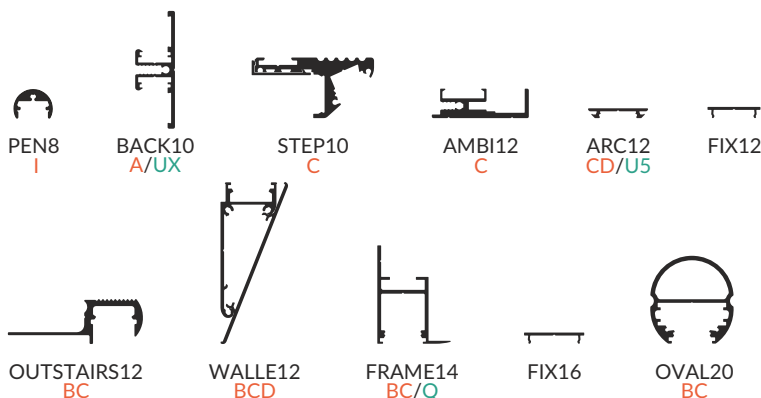

glass application LED profiles

TWIN8	6.01
MIKRO10	6.03
EDGE10 BC	6.05
MIKRO-LINE12 J	6.09



VARIO30

VARIO30-01	7.06
VARIO30-02	7.06
VARIO30-03	7.06
VARIO30-08	7.06
VARIO30-09	7.07
VARIO30-10	7.07
FIX16	7.07
VARIO30-04	7.14
VARIO30-05	7.14
VARIO30-06	7.14
VARIO30-07	7.14

SURFACE

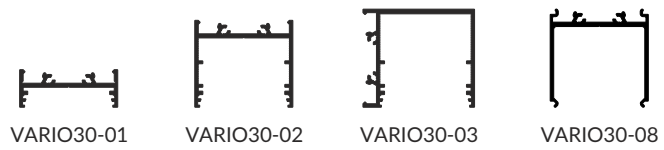

POWER SUPPLY PROFILE

ASSISTANT PROFILES



RECESSED - SPACKLE FLANGE MOUNTING

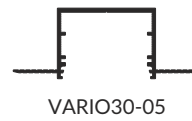

RECESSED

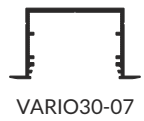

big profiles

PHIL53	8.02
PHIL recessed	8.02
LOWI	8.03

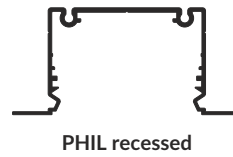
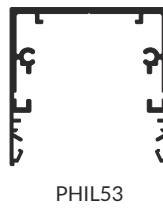

LED accessories

lighting controllers and switches	9.07
RGB lighting system	9.08
Vario white lighting system	9.10
LED profile slings	9.10
tilted bracket for LED profiles	9.11
cables, extensions, connectors	9.11
other accessories	9.12
	9.13

profile categories



SURFACE

LED profiles with the most universal applications. Installation on a flat surface, most commonly with the use of aluminium holders or steel flexible mounting plates but also with the use of screws, or assembly tapes.

It is worth to note the following profiles: SLIM8, SMART10, BEGTON12, SMART16, WIDE24: Slick socket - easy cover assembly. SURFACE10, SURFACE14, LINEA20: hidden mounting.

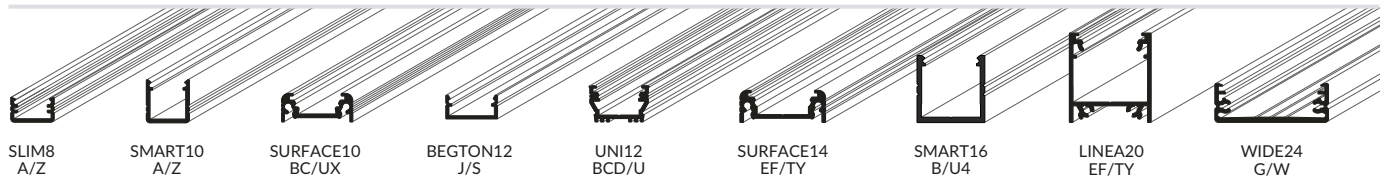

RECESSED

The advantage of embedding a profile is obtaining an illuminating surface which almost levels with the plane of the wall or furniture. Profile installation requires surface preparation - cutting a longitudinal opening in the furniture (HI8, GROOVE10, BEGTIN12, GROOVE14), a plasterboard (FLAT8, DEEP10) or leaving an appropriate distance when installing the tiles (FLOOR12).

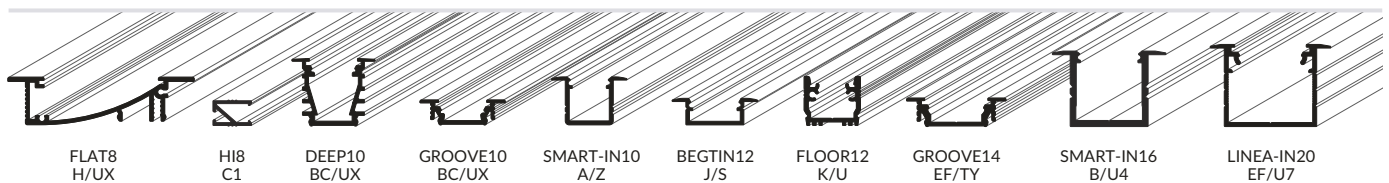

CORNER

To be used in the corners of wall, furniture and cabinets. Installation with mounting plates, screws, assembly tape.

The asset of the CORNER10, CORNER14 and CORNER27 collections is the hidden mounting. These profiles provide a possibility to direct the light at an angle of 30° or 60° to the assembly plane.

The CABI12 profile is designed for glass cabinets, then adhesive mounted. It allows to avoid glare. Installation at an angle of 30° or 60°.

Thanks to the symmetric cross-section, the profiles can be joined in the corners at an angle of 90°.

TRIO10 - for lighting at an angle of 45°.

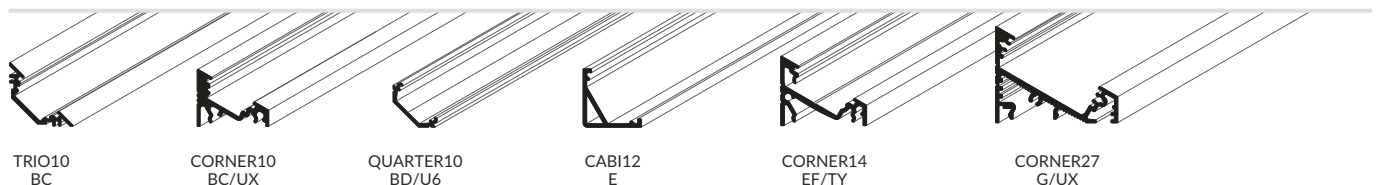



SPECIAL APPLICATION

A group of profiles with a broad application spectrum - for the ceiling, wall, architectural, stair, wardrobe. Designed for specialist applications. Among them, the PEN8 with the highest number of holders (i.a.: extension arms, flat, simple and stretcher holders) for creating a number of combinations and achieving the defined illumination effects.

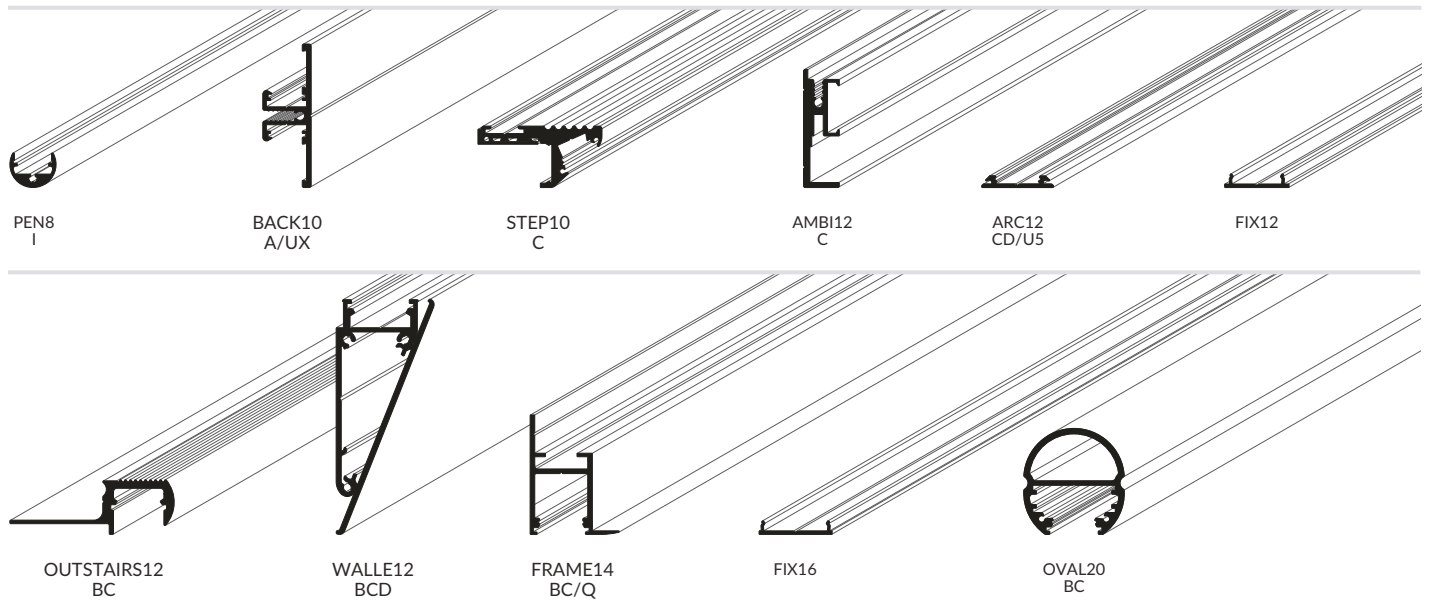

GLASS APPLICATION

Profiles for glass are used to exhibit objects in cabinets and to illuminate the sanded advertising or decorative graphics. Installed on the edge of the glass panel, they do not constitute a shelf supporting structure. EDGE10 - in contrast to the other ones - is applied on the face of the shelf, which allows to better light up the exhibits under the shelf or above it (after rotating the profile by 180°).



What does a profile name indicate?

SURFACE10 BC/UX

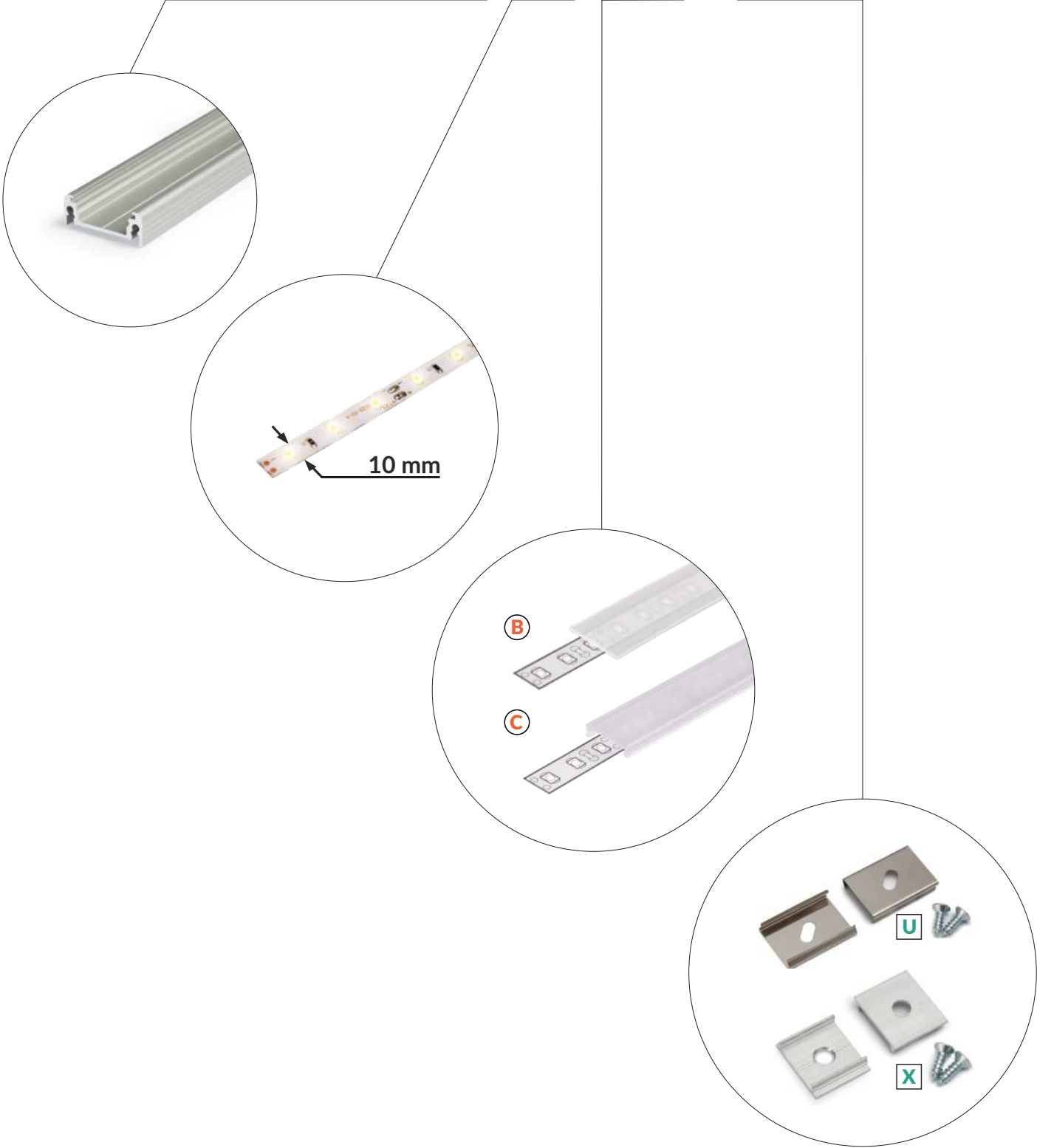

Slick

We also have profiles with the Slick socket in our assortment. This feature allows to click in or slide in the cover.

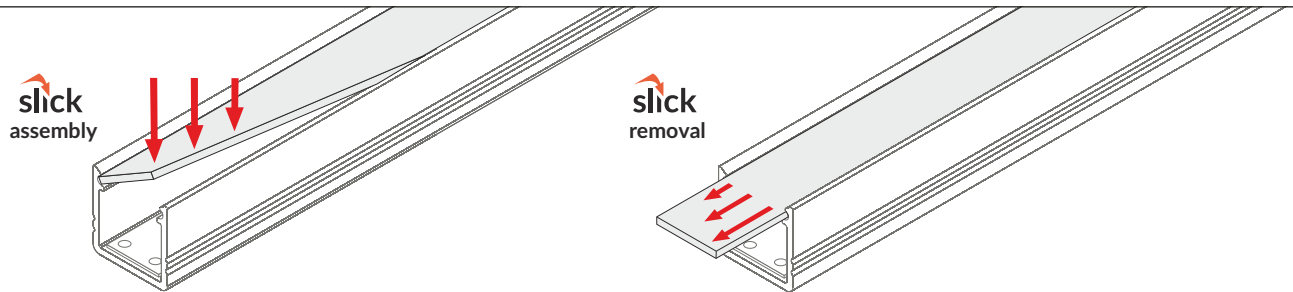

Profiles with Slick socket:

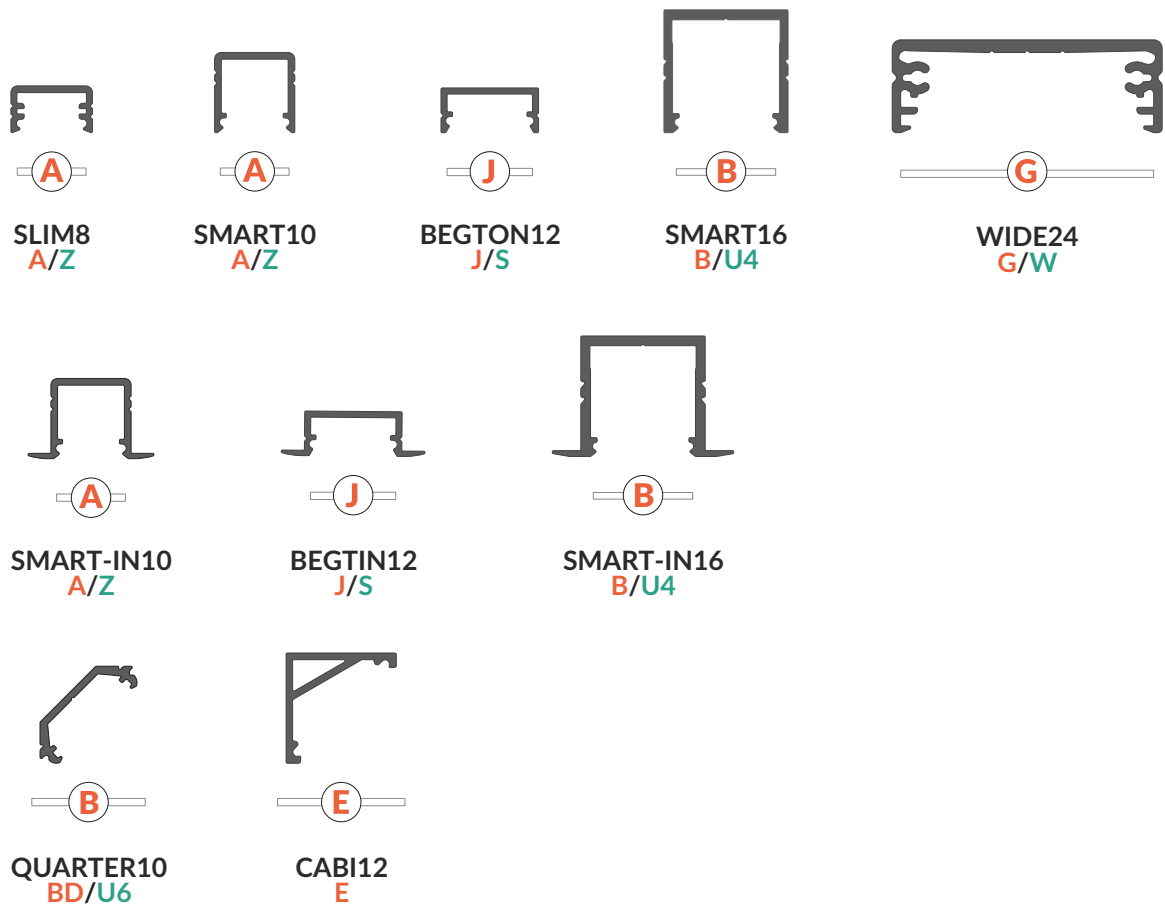

How to select a cover?

Covers for aluminium LED profiles differ in the degree of transparency. Thanks to a conscious choice, you can plan the lighting effect, light dispersion and distribution better. A transparent cover absorbs a smaller amount of light, followed by frosted and opal ones.

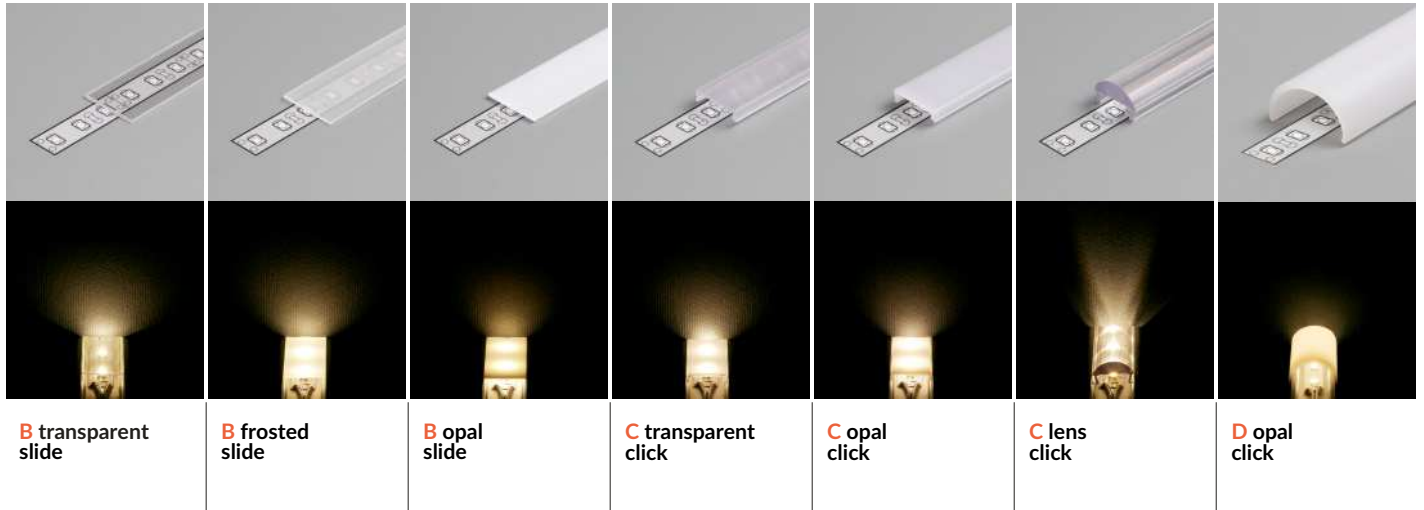

It also means a different degree of visibility of LED points. Opal covers in some profiles, in conjunction with a 120 P/m tape, allow to achieve the effect of a continuous line of light.

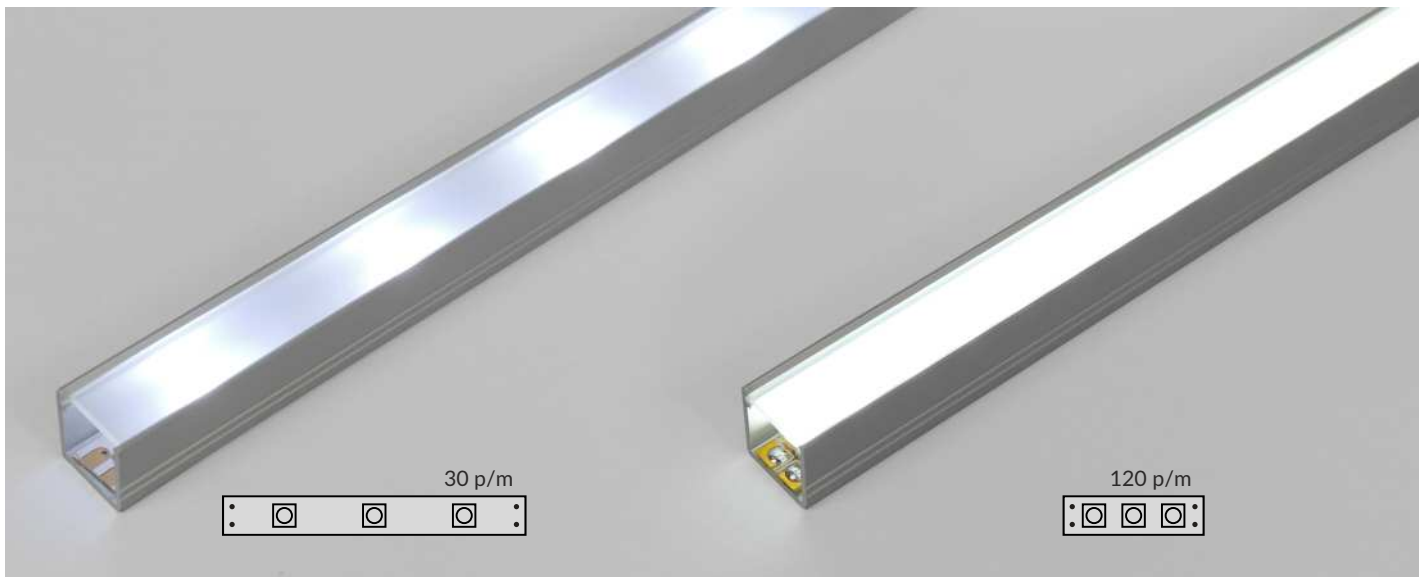

The covers also differ in the method of assembly.

SLIDE COVER (labelling: A, B, E, G, H, J)

It is a strip of plastic available in 3 different degrees of transparency. It needs to be slid from the beginning of the profile and dragged along the marked socket or clicked in the Slick socket.

CLICK COVER (labelling: C, C1, D, E7, F, I, K)

Its assembly and removal are more convenient. Access to the ends of the profile is not necessary, which allows to click in the cover even after installing the profile in a recess or a piece of furniture.

Many of the covers in the offer are system accessories. It means that one cover fits a few, different profiles.

A letter describing the socket helps correct matching.

And so, e.g., the SURFACE10 BC/UX profile can be fitted with the covers:

- B slide
- C click
- C lens





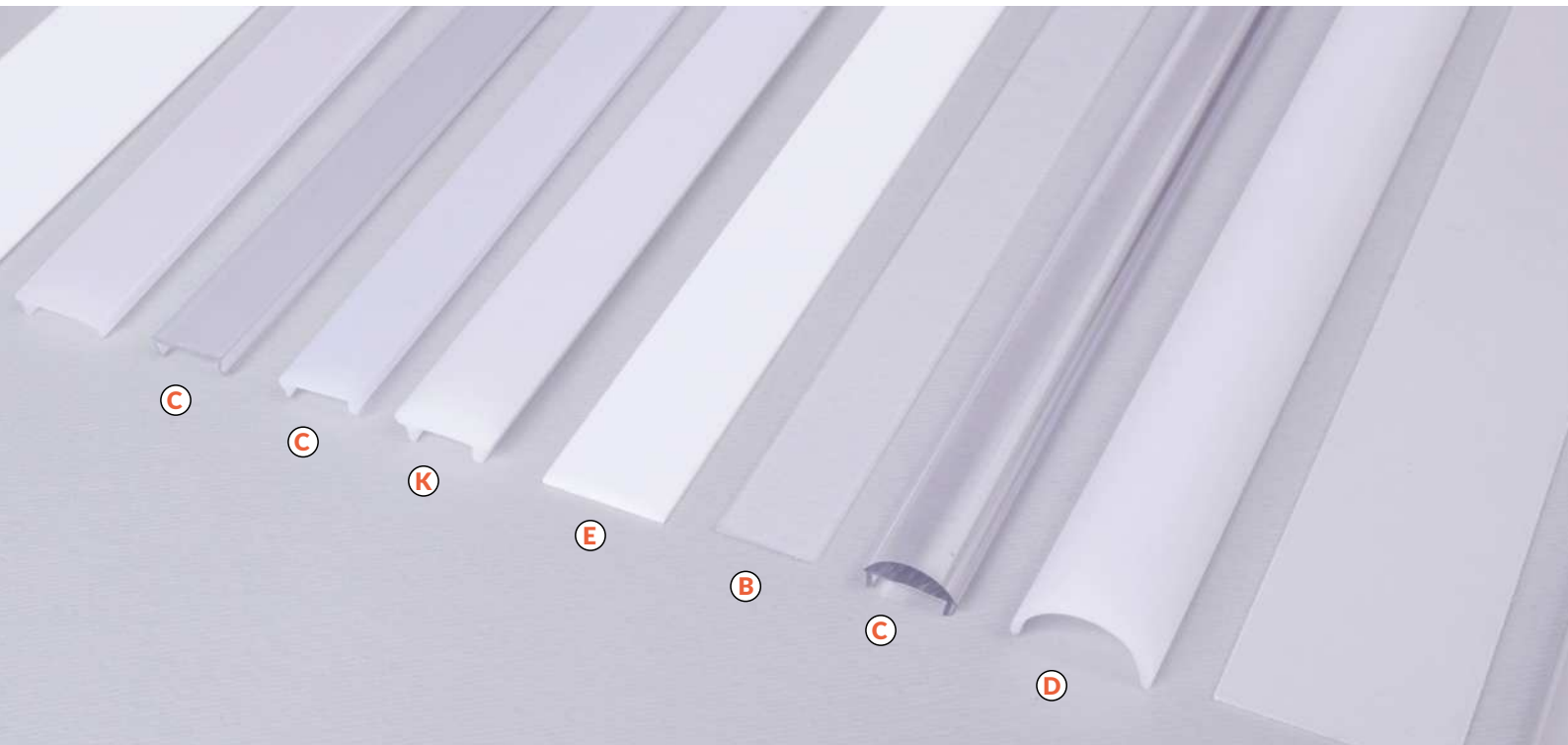





Cover C click, on the other hands, fits the profiles:

- SURFACE10 BC/UX
- UNI12 BCD/U
- GROOVE BC/UX
- DEEP10 BC/UX
- TRIO10 BC
- CORNER10 BC/UX
- EDGE10 BC
- STEP10 C
- WALLE12 CD
- AMBI12 C
- ARC12 CD/U5
- OUTSTAIRS12 BC
- FRAME14 BC/Q
- OVAL20 BC



Covers

The covers in the offer differ between one another not only in terms of the achieved lighting effect but also in terms of technical parameters. Among the special cover, one stands out in particular - designed for the FLOOR12 LED profile, the K white cover. Its characteristic feature is the high resistance to damage and impacts with a degree of IK 08. This is why it is possible to tread over it - without having to worry about cracking or scratching.

cover type	material	work temperature		UV resistance	fire hazard certificate according to IEC 60695-2-11	transparency	coefficient diffusion
		min [°C]	max [°C]				
 transparent	PC	-50	100	✓	✓	93%	low
 frosted	PP	-15	85	✓	✓	90%	low
 opal	PP	-15	85	✓	✓	70%	high
 transparent	PMMA	-20	70	✓	✓	93%	low
 opal	PMMA	-20	70	✓	✓	75%	low
 lens	PC	-50	100	✓	✓	90%	low
 opal	PMMA	-20	70	✓	✓	70%	high
 opal	PMMA	-20	70	✓	✓	70%	high
 opal	PMMA	-20	70	✓	✓	70%	high
 transparent	PMMA	-20	70	✓	✓	93%	low
 opal	PMMA	-20	70	✓	✓	75%	medium
 frosted	PC	-50	100	✓	✓	90%	low
 opal	PC	-50	100	✓	✓	80%	medium
 opal	PC	-50	100	✓	✓	60%	high

Tolerance

We make every effort to maintain maximum repeatability of our products. Despite this, there may be small differences between the individual batches due to the nature of the manufacturing processes. That is why we always recommend considering the following tolerances.

LENGTH	
	Standard tolerance
PROFILES	+2 mm
COVERS	+20 mm
	Minimal tolerance
PROFILES	+0,2 mm
COVERS	+0,2 mm

Note. The preparation of products with non-standard tolerance increases costs, extends lead time and requires indication of the desired tolerance in the order.

TEMPERATURE EXPANSION	
	Value stated for the difference of 10°C, per linear metre
PROFILES	0,23 mm
COVERS	C10 NARROW: 0,7 mm
	C10 WIDE: 0,7 mm
	C10 OPAL: 0,8 mm
	others: 0,2~0,3 mm

COLOUR	
ANODIZED SURFACES	silver: C-0
	black: C-35
PAINTED SURFACES (according to the RAL palette)	white: RAL 9003 mat
	black: RAL 9005 mat

Mounting accessories

SYSTEM ACCESSORIES - fit many different profiles.

DEDICATED ACCESSORIES - matched to one profile, are usually used for a more precise assembly method: pendant, on an extension arm, at an angle, etc.

MOUNTING PLATES, HOLDERS

flexible



U flexible mounting plate



cone U flexible mounting plate



rack U flexible mounting plate

aluminium



X mounting plate



T mounting plate

simple - for perpendicular assembly in a furniture board (cabinets)



SLIM8 simple holder



SURFACE10 simple holder



WIDE24 simple holder



PEN8 simple holder



OVAL20 simple holder

„cone” or „slot”?

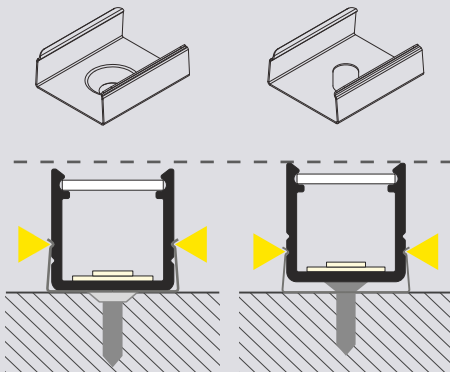

EXTENSION ARMS



OVAL20 double extension arm



PEN8 double holder with thread



PEN8 jointed holder with soffit ceiling

CONNECTORS

Easy method of joining 2 profile sections in a straight line or at a defined angle.



X connector 180 deg



SURFACE10 connector 90 deg



LINEA20 connectors

- 60°
- 90°
- 120°
- 135°
- 180°



T connector 180 deg



GROOVE10 connector 90 deg

LINEA20 bent connectors

- 90°
- 270°



CORNER10 connector 90 deg

SLINGS

They enable creating pendant luminaires. They are especially recommended for the LED LINEA 20 profile (see pages 2.27-2.28) but are also compatible with most of the profiles.

MAX
50 V



SELV sling 50V 1500



sling for LED mounting 1500



Endings

The endings, with the aim to aesthetically close the profile and additionally protect the LED source, come in four basic colours: silver, white, black and grey. The endings selected for the profiles for glass are available in transparent colour. Covers endings are available in opal colour. The material used for the production of the endings meets the lighting non-combustibility standard no.: PN-EN 60695-2-11. Material: ABS, PC.

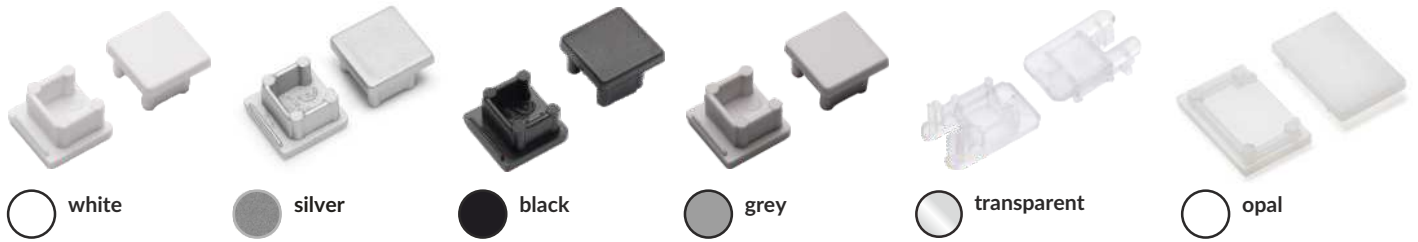

Endings with a hole or without it - which one to choose? Many of our endings come in two versions:



With a hole: they allow aesthetic outlet for a cable without the need to drill through the ending or the profile.



Without a hole: they are an aesthetic and a tighter ending of the profile. Recommended in cases where the appearance is particularly significant, or from the opposite side to the cable outlet.

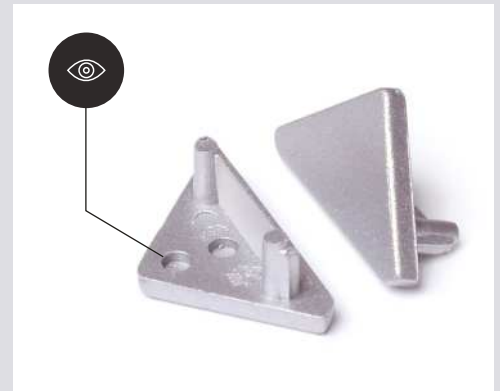

For new products, we offer endings with points to bore a hole. Thanks to this, from one set of endings, it is possible to obtain one ending of each type: with a hole and without one. They are available for the profiles: ARC12, BEGTON12, CABI12, LINEA20, QUARTER10, TRIO10.

Markings

marking of covers fitting the sockets in the profile

A B C C1 D E E7 F G H I J K

marking of holders fitting the profile

S T U U4 U5 U6 U7 W X Y Z

profile with Slick socket



LED profile categories



surface



recessed



corner



special application



glass application

others



maximum LED strip width



note



assembly adhesive



EU-registered industrial design

LED accessories

Different LED sources and electronic components can be used for aluminium LED profiles. The correct sequence of connecting individual elements is very important.

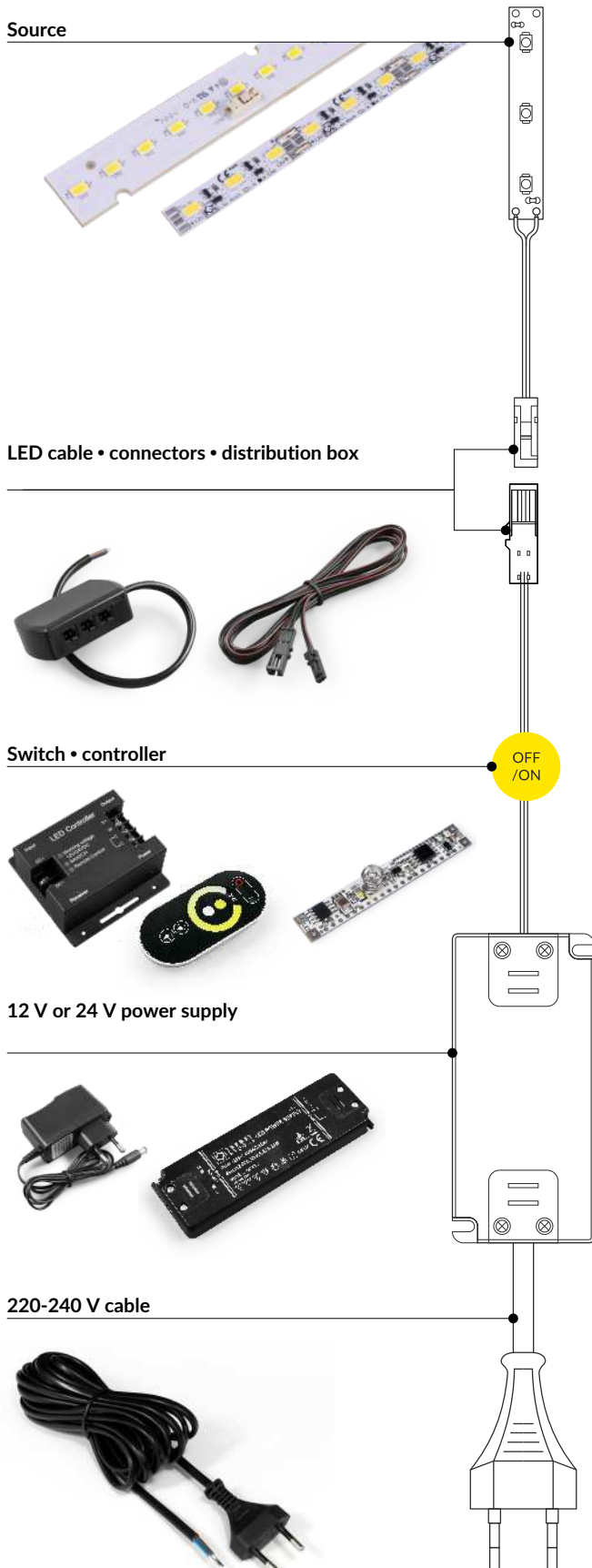

We have LED strips with different power, luminous flux and width to choose from. We also have strips available with different light colour temperatures - a few different temperatures of white and primary colours, as well as RGB and warm-cold (with adjustable light colour temperature). The most commonly used sources are the ones for the 12 V voltage but sources for the 24 V voltage are also available. Apart from the most popular LED strips available on the market, there are also LED modules on a rigid surface. They are usually characterized by better light parameters and quality. Waterproof sources and components are a special part of the offer.

Depending on the LED selection, you need to match the remaining accessories: cables, connectors, switches, controllers and power supplies.

Some LED sources available on the market may exceed radiation capabilities of a given aluminium profile. In order to ensure correct operation, a LED source with appropriate parameters needs to be matched to an aluminium profile.

In the case of connecting a few sources to one power supply, you can use a connector for mini-connector with 6 sockets or a LED divider. Our offer also includes cables of different lengths for one colour of LED strips, as well as special ones for RGB strips and separately, for waterproof strips.

A lighting fixture set can be enriched with different types of convenient solutions regarding switching, dimming and change of colour. Mechanical switches are available - integrated with the cable or for connecting directly to the LED source, under the cover inside the profile. Turning on is possible both by touch, as well as radio waves - with a remote control via a controller. You can control the colour (with an appropriate light source selected) as well as illuminance.

The selection of the power supply requires calculation of the power to be consumed by the source, according to the indications of the manufacturer. From the primary side, the current has a voltage of 220-240 V, on the secondary side, to which the LED is connected, the voltage is 12 V or 24 V.

220-240 V cables, which allow the connection of an entire set to the power supply are also in our offer. A standard cable is 4 m long and a cable with a foot switch - 3.5 m.

More details are available in the LED accessories catalogue (pages: 9.02-9.13).

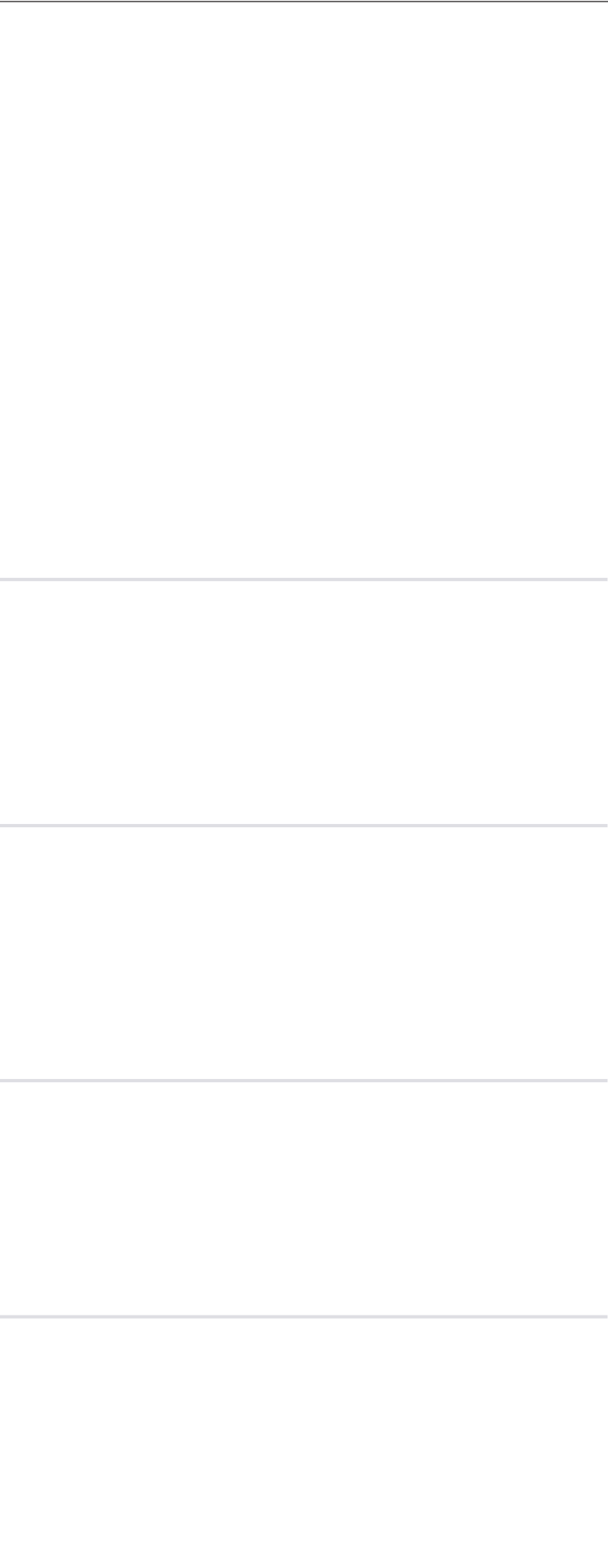

WAY10 C

ILLUMINATING SKIRTING



max 10 mm



special application

Matching accessories:
C click cover;
WAY10 ending.

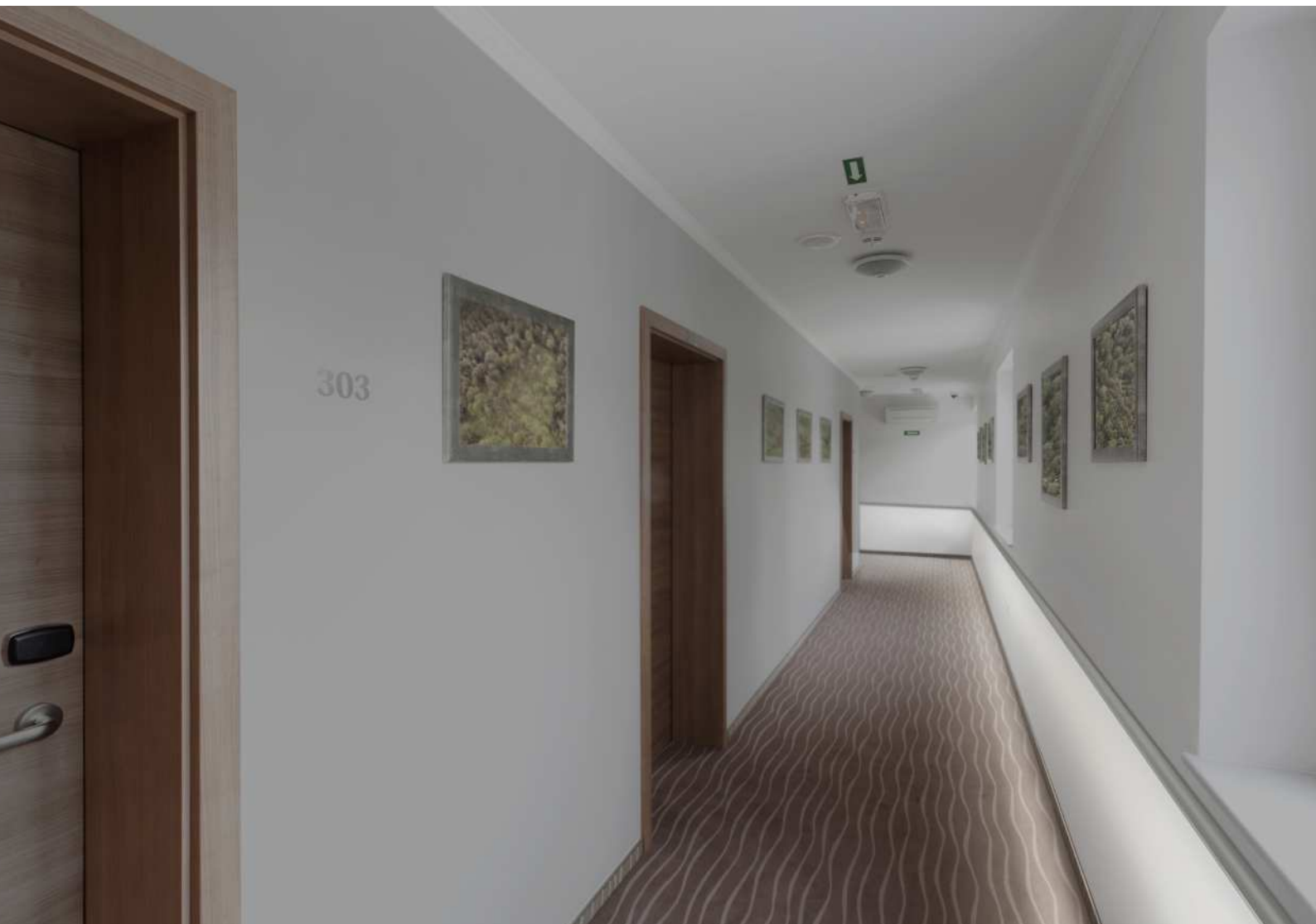
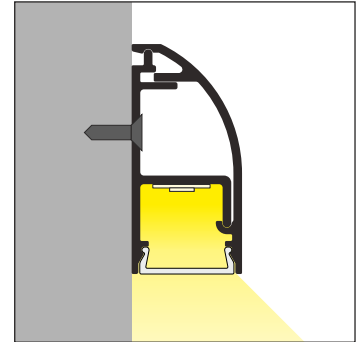
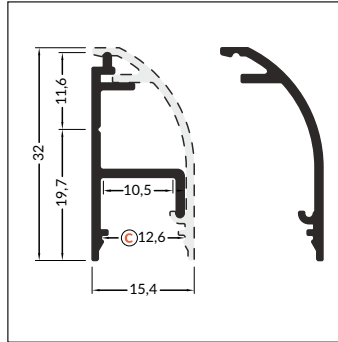

PEN12 CJ

PROFILE FOR PAINTINGS



max 12 mm



special application

Matching covers:
C click cover, J slide cover;
other accessories available soon.

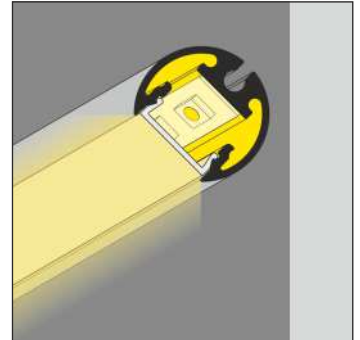
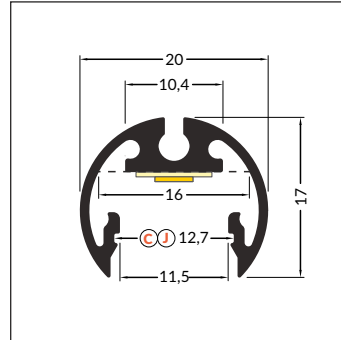

SMALL, ALUMINIUM, SURFACE PROFILE

- universal application
- Slick socket
- 2 channels for mounting bracket (with or without wall distance)
- painted holders
- maximum LED strip width: 8 mm

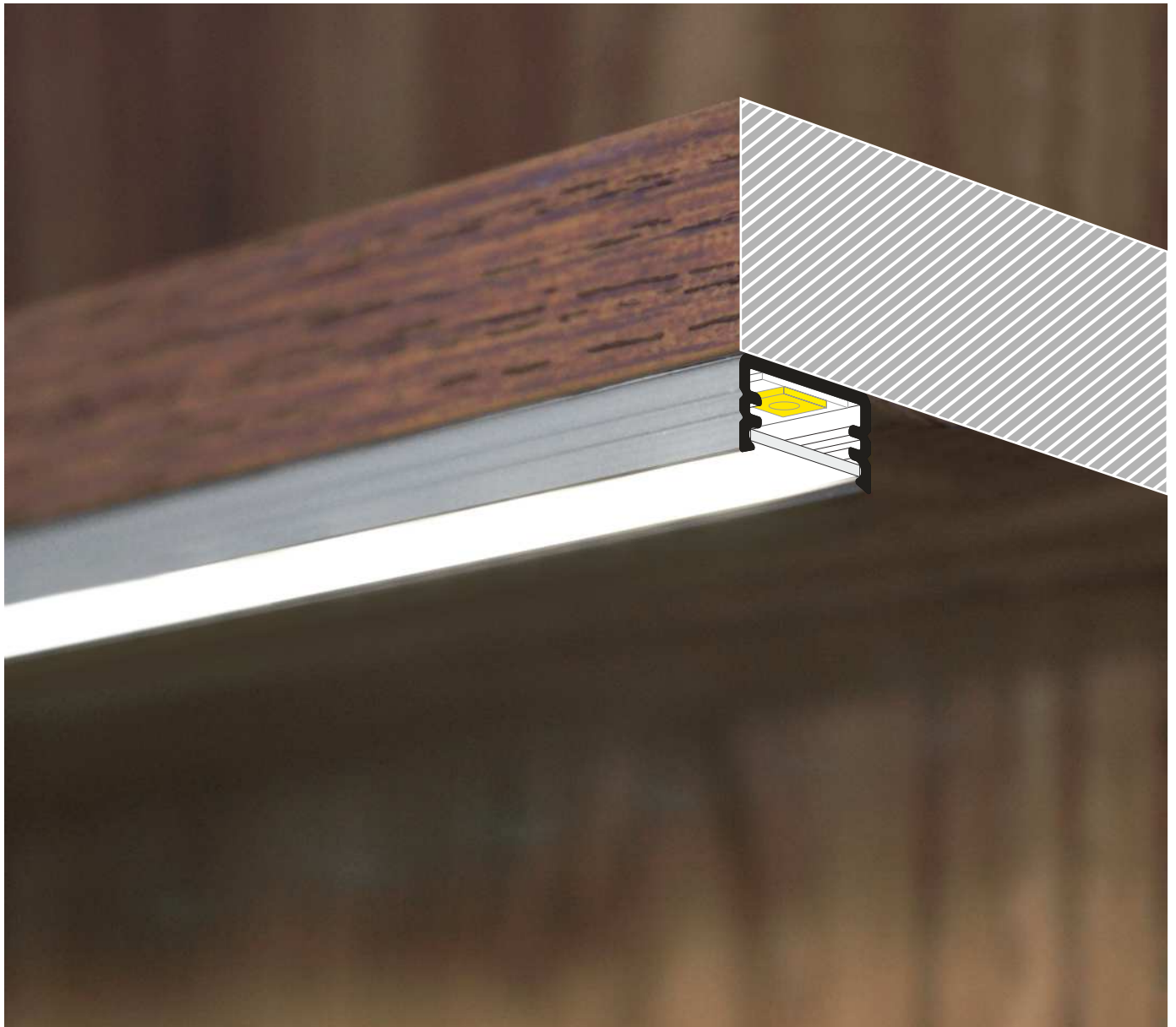

SIMILAR IN THE OFFER





A slide cover

Z¹ Z flexible mounting plate

Z² cone Z flexible mounting plate

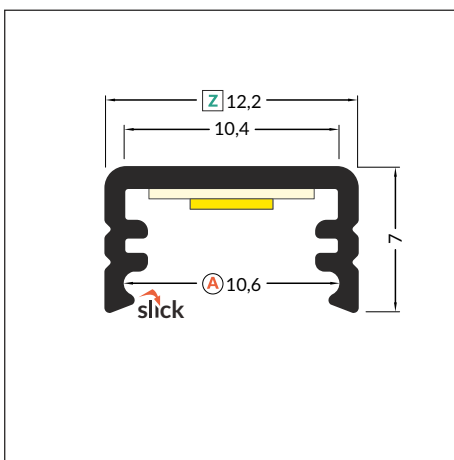
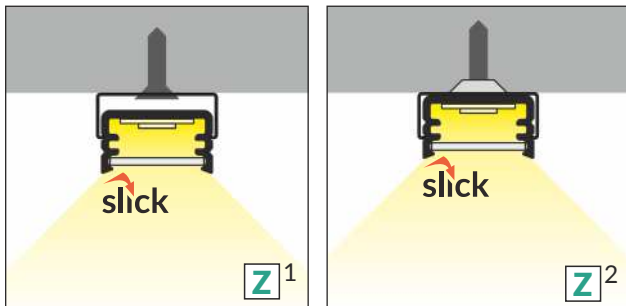
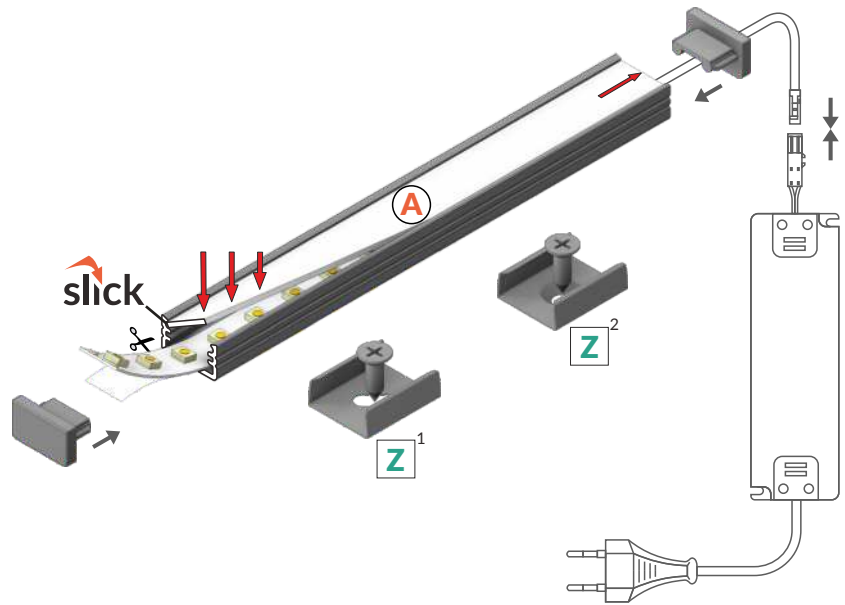



 max 8 mm

 surface



INDEX = 1 pc, length 2000 mm
package = 10 pcs

 white painted
89030001

 anodized
89030020

 black anodized
89030021

 raw aluminium
89030000

Available lengths: 1000 mm, 2000 mm, 3000 mm, 4000 mm.
The standard profile length tolerance is +2 mm.
For more details please see page 1.08.

ACCESSORIES

COVERS

A slide cover
 colours: transparent, frosted, opal
 material: PC, PP, PP

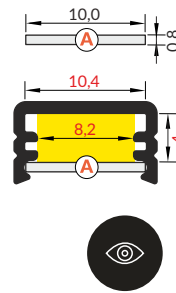

Note! Dimensions of the space to install LED source



INDEX = 1 pc, length 2000 mm
 package = 10 pcs

A transparent
 89070016

A frosted
 89070039

A opal
 89070038

The standard cover length tolerance is +20 mm.
 For more details please see page 1.08.

ENDINGS

SLIM8 ending
 colours: white, silver, black, grey
 material: ABS

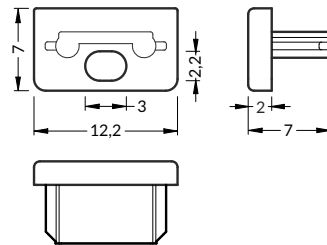

SLIM8 ending with hole
 colours: white, silver, black, grey
 material: ABS

INDEX = 1 set
 package = 10 sets = 20 pcs .

	white	
	with hole	without hole
	89140001	89080001
	silver	
	with hole	without hole
	89140040	89080040
	black	
	with hole	without hole
	89140002	89080002
	grey	
	with hole	without hole
	89140022	89080022

MOUNTINGS

Z flexible mounting plate
 colours: white, inox, black
 material: stainless steel

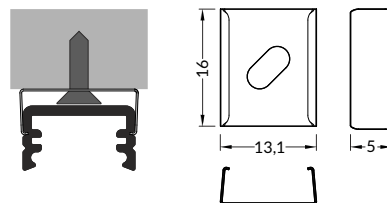

cone Z flexible mounting plate
 colours: white, inox, black
 material: stainless steel

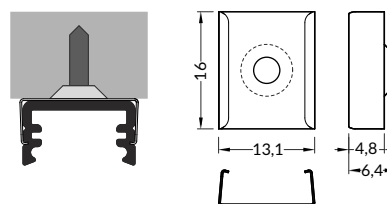

SLIM8 simple holder
 material: zinc coated steel

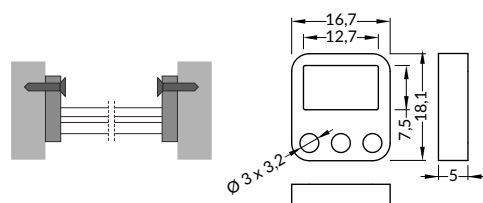

INDEX = 1 set
 package = 10 sets = 20 pcs

Z flexible mounting plate

	white	89270001
	inox	89270019
	black	89270002

cone Z flexible mounting plate

	white	89980001
	inox	89980019
	black	89980002

INDEX = 1 set = 2 pcs

simple holder

	zinc coated	89110030
--	-------------	----------



ACCESSORIES

CONNECTORS

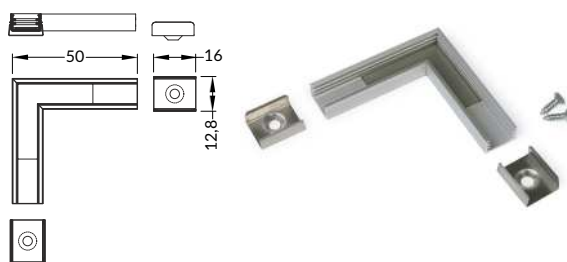
SLIM8 connector 90 deg
colours: white, anodized, black
material: aluminium



INDEX = 1 set

-  white painted
89150001
-  anodized
89150020
-  black anodized
89150021



CONTINUOUS LINE OF LIGHT IN A SMALL OVERALL DIMENSIONS

- continuous line of light (when using LED strip 120 P/m and opal cover)
- SLICK socket
- miniature dimensions
- universal application
- the possibility of using waterproof LED strips
- maximum width of LED strip: 10 mm

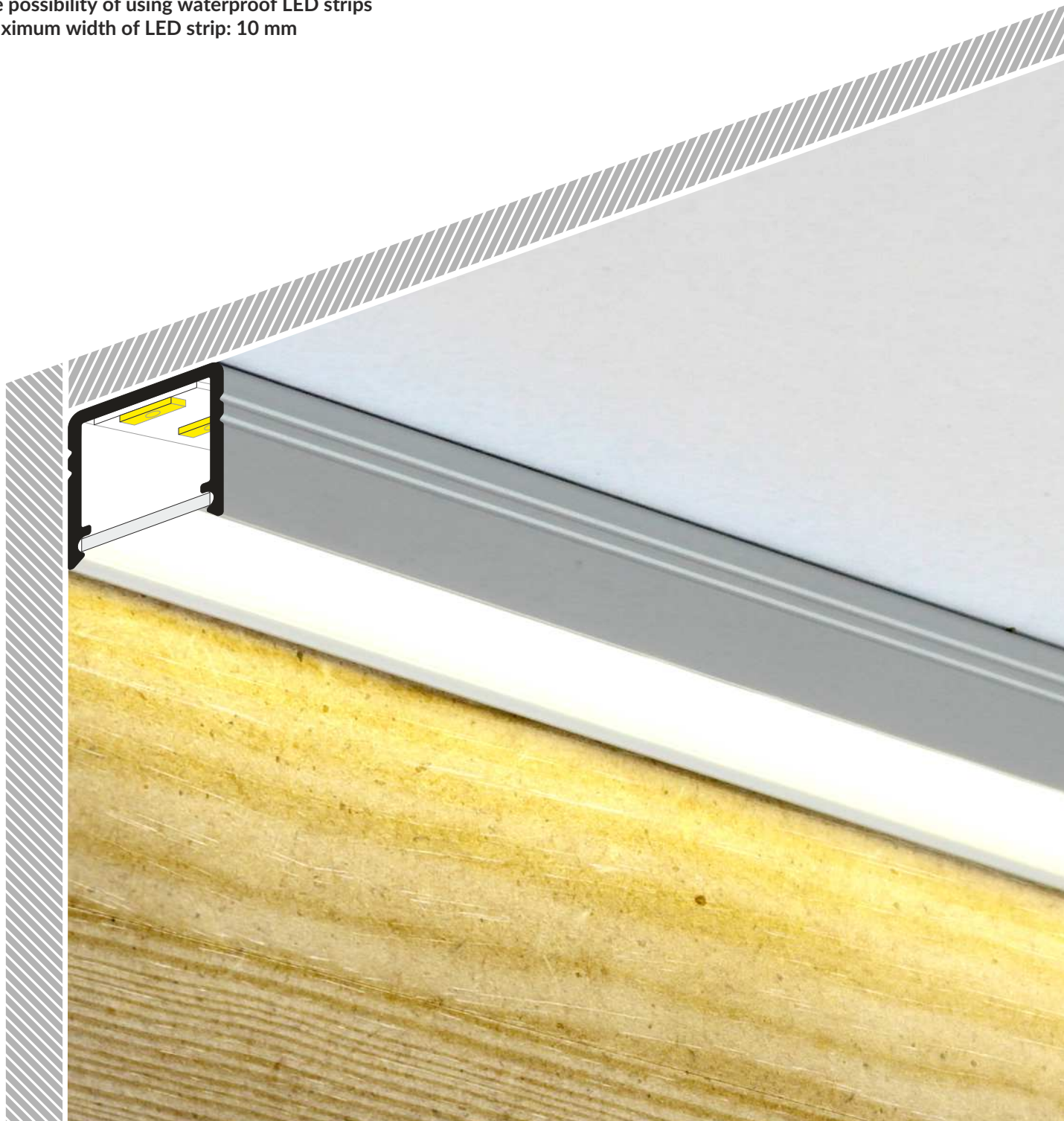

SIMILAR IN THE OFFER





A slide cover

Z¹ Z flexible mounting plate

Z² cone Z flexible mounting plate

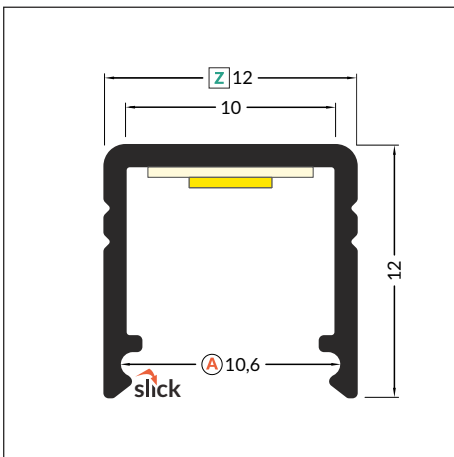
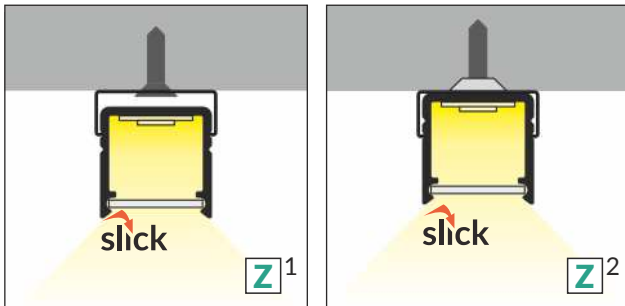
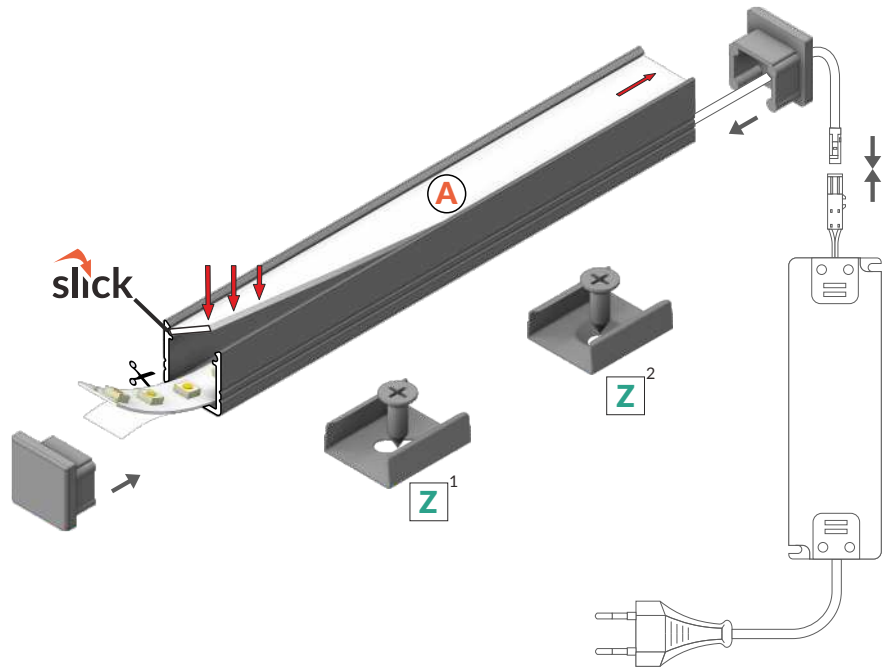

max 10 mm

surface



INDEX = 1 pc, length 2000 mm
package = 10 pcs

white painted
C2020001

anodized
C2020020

black anodized
C2020021

raw aluminium
C2020000

Available lengths: 1000 mm, 2000 mm, 3000 mm, 4000 mm.
The standard profile length tolerance is +2 mm.
For more details please see page 1.08.

ACCESSORIES

COVERS

A slide cover
 colours: transparent, frosted, opal
 material: PC, PP, PP



Note! Dimensions of the space

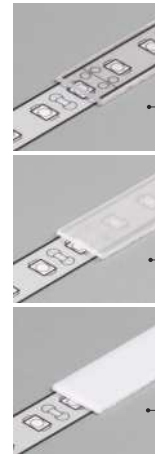
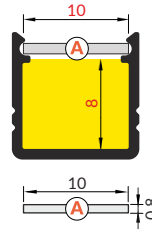

INDEX = 1 pc, length 2000 mm
 package = 10 pcs

A transparent
 89070016

A frosted
 89070039

A opal
 89070038

The standard cover length tolerance is +20 mm.
 For more details please see page 1.08.

ENDINGS

SMART10 ending
 colours: white, silver, black, grey
 material: ABS

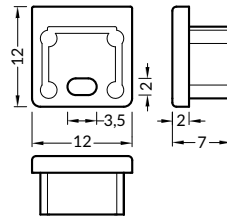

SMART10 ending with hole
 colours: white, silver, black, grey
 material: ABS

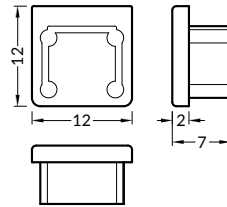

INDEX = 1 set
 package = 10 sets = 20 pcs

○ white
 without hole | with hole
 C2940001 | C2960001

● silver
 without hole | with hole
 C2940040 | C2960040

● black
 without hole | with hole
 C2940002 | C2960002

● grey
 without hole | with hole
 C2940022 | C2960022

MOUNTINGS

Z flexible mounting plate
 colours: white, inox, black
 material: stainless steel

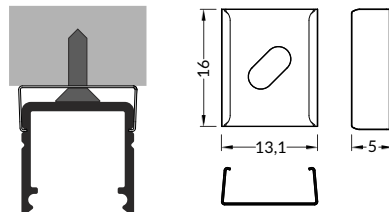

INDEX = 1 set
 package = 10 sets = 20 pcs

Z flexible mounting plate

○ white 89270001

● inox 89270019

● black 89270002

cone Z flexible mounting plate
 colours: white, inox, black
 material: stainless steel

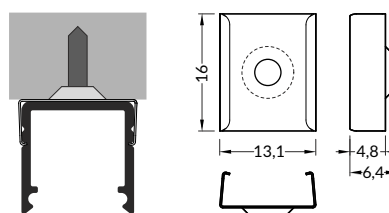

cone Z flexible mounting plate

○ white 89980001

● inox 89980019

● black 89980002

ACCESSORIES

CONNECTORS

SMART10 connector 90 deg
colours: white, anodized, black
material: aluminium

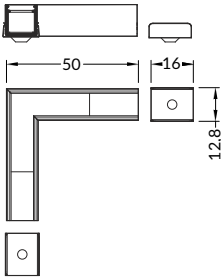

INDEX = 1 set

- white painted
C2910001
- anodized
C2910020
- black anodized
C2910021



SURFACE10 BC/UX

ALUMINIUM SURFACE PROFILE

- hidden mounting
- wide range of accessories, 6 types of covers
- maximum LED strip width: 10 mm

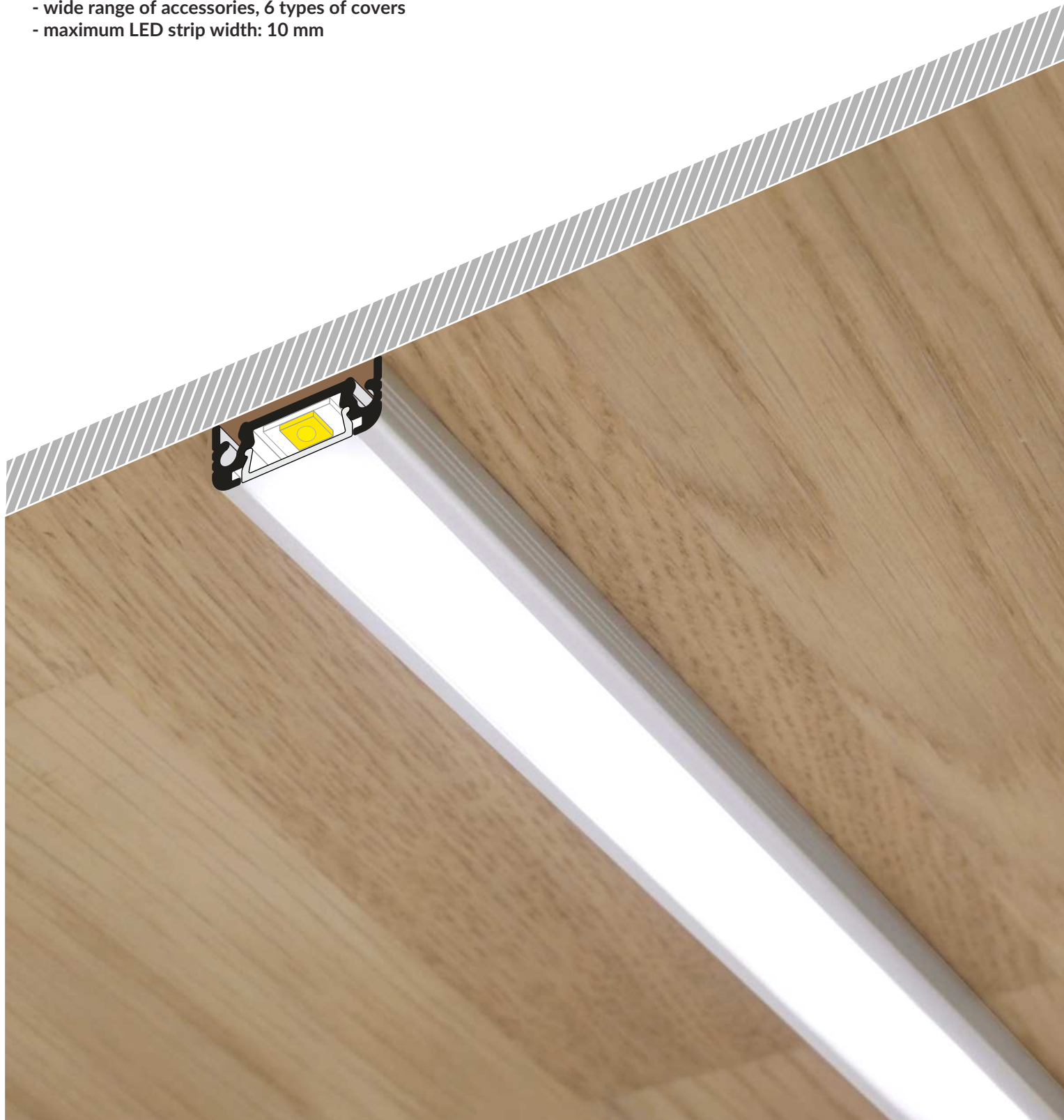

SIMILAR IN THE OFFER

SLIM8
A/Z

SMART10
A/Z

BEGTON12
J/S

SURFACE14
EF/TY

LINEA20
EF/TY





WIDE24
G/W

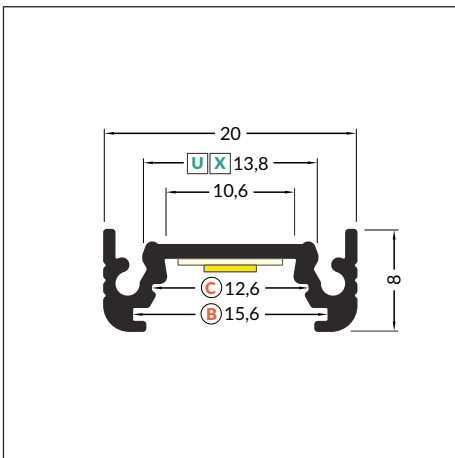
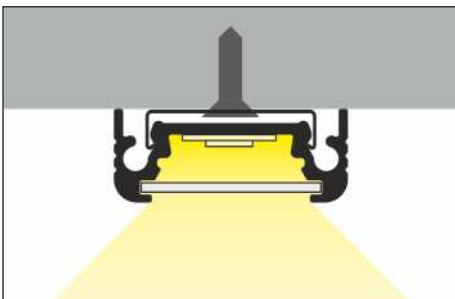
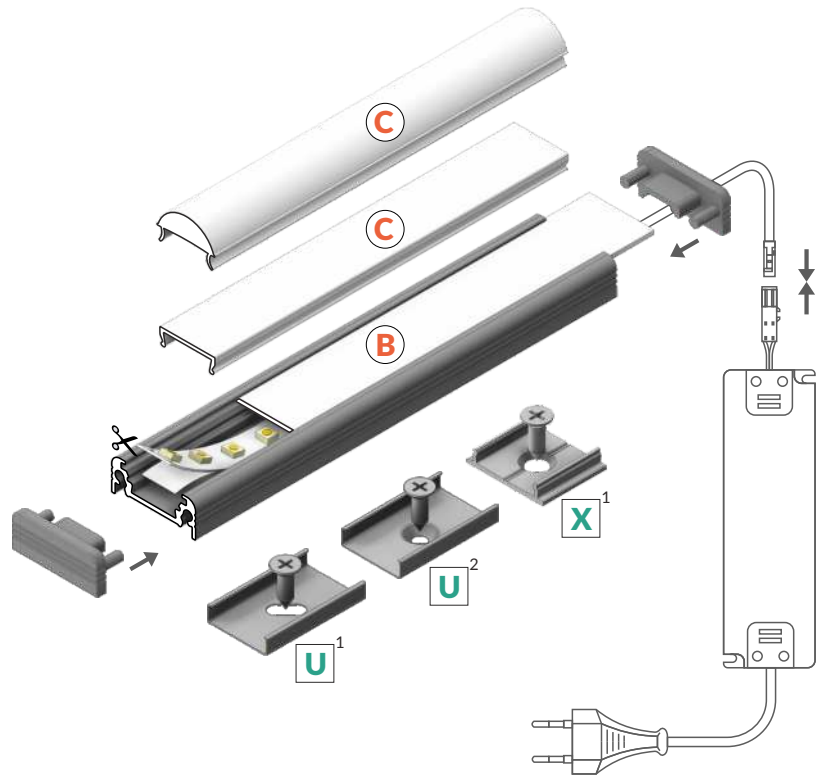

- B** slide cover
- C** click cover
- C** lens cover
- U**¹ U flexible mounting plate
- U**² cone U flexible mounting plate
- X**¹ X mounting plate



INDEX = 1 pc, length 2000 mm
package = 10 pcs

-  white painted
77270001
-  anodized
77270020
-  black anodized
77270021
-  raw aluminium
77270000

Available lengths: 1000 mm, 2000 mm, 3000 mm, 4000 mm.
The standard profile length tolerance is +2 mm.
For more details please see page 1.08.

ACCESSORIES

COVERS

B slide cover
 colours: transparent, frosted, opal
 material: PC, PP, PP

C click cover
 colours: transparent, opal
 material: PMMA

C click cover lens
 colour: transparent
 material: PC



Note! Dimensions of the space to install LED source

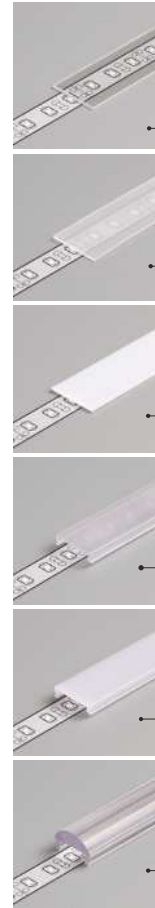
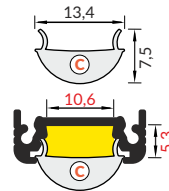
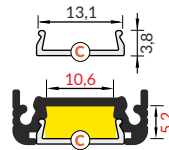
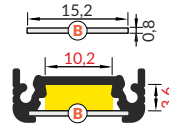

INDEX = 1 pc, length 2000 mm
 package = 10 pcs

B transparent
 76250016

B frosted
 76250039

B opal
 76250038

C transparent
 76330000

C opal
 76330038

C lens
 76300000

The standard cover length tolerance is +20 mm.
 For more details please see page 1.08.

MOUNTINGS

U flexible mounting plate
 colours: inox
 material: stainless steel

cone **U** flexible mounting plate
 colours: inox
 material: stainless steel

X mounting plate
 colours: raw aluminium
 material: aluminium

SURFACE10 simple holder
 material: zinc coated

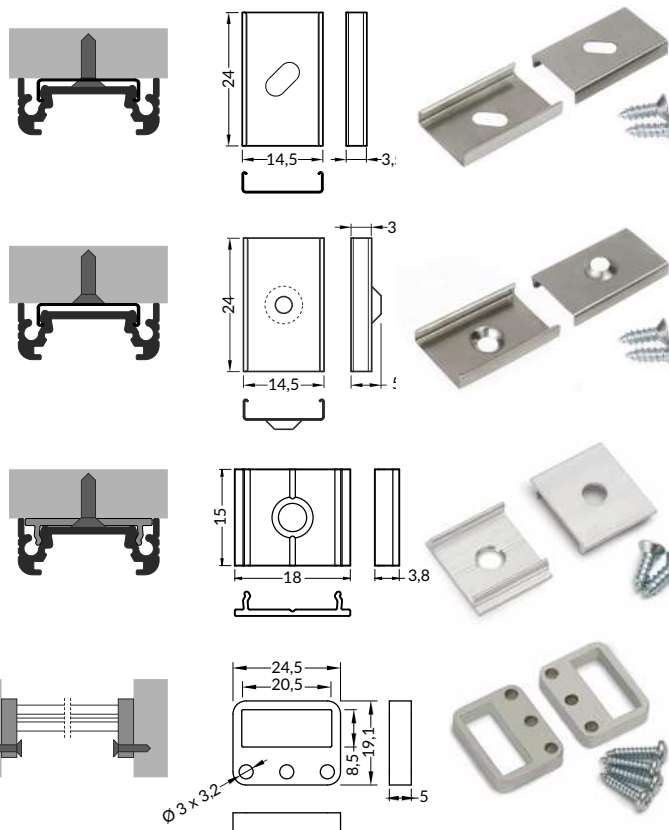

INDEX = 1 set
 package = 10 sets = 20 pcs

U flexible mounting plate

inox 76380000

cone **U** flexible mounting plate

inox 76620000

X mounting plate

raw aluminium
 76260000

INDEX = 1 set = 2 pcs

simple holder

zinc coated
 77370030

ACCESSORIES

ENDINGS

SURFACE10 ending gen2
 colours: white, silver, black, grey
 material: ABS

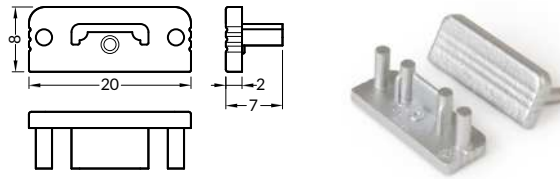

SURFACE10 ending gen2 with hole
 colours: white, silver, black, grey
 material: ABS

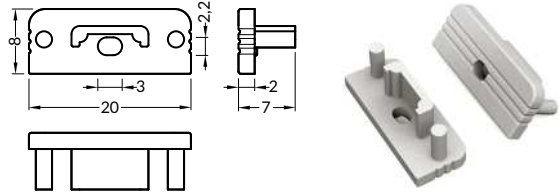

INDEX = 1 set
 package = 10 sets = 20 pcs

- | | |
|-----------|--------------|
| ○ white | |
| with hole | without hole |
| 77980001 | 77990001 |
| ● silver | |
| with hole | without hole |
| 77980040 | 77990040 |
| ● black | |
| with hole | without hole |
| 77980002 | 77990002 |
| ● grey | |
| with hole | without hole |
| 77980022 | 77990022 |

CONNECTORS

X connector 180 deg
 colour: inox
 material: aluminium

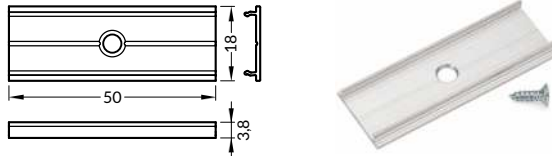

SURFACE10 connector 90 deg
 colours: white, anodized, black
 material: aluminium

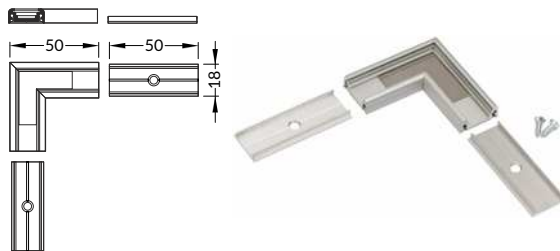

INDEX = 1 set

- X connector
- | | |
|-----------------|---------------------|
| ● raw aluminium | |
| | 6350000 L connector |
-
- | | |
|------------------|----------|
| ○ white painted | |
| | 77410001 |
| ● anodized | |
| | 77410020 |
| ● black anodized | |
| | 77410021 |



BEGTON12 J/S



SMALL SURFACE ALUMINIUM PROFILE

- light weight, budget profile
- Slick socket
- maximum LED strip width: 12 mm



SIMILAR IN THE OFFER



SLIM8
A/Z



SMART10
A/Z



SURFACE10
BC/UX



BEGTIN12
J/S



SURFACE14
EF/TY



J slide cover

C click cover

C* BEGTON12 C ending for C click cover

S¹ S flexible mounting plate

S² cone S flexible mounting plate

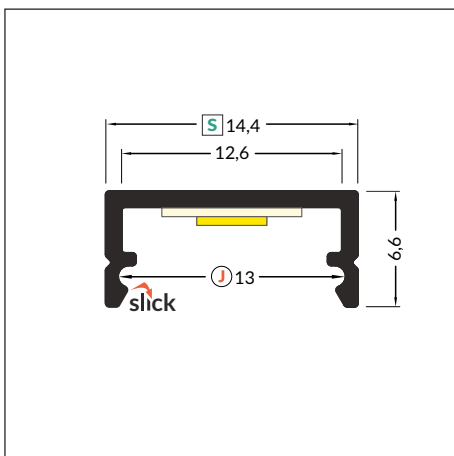
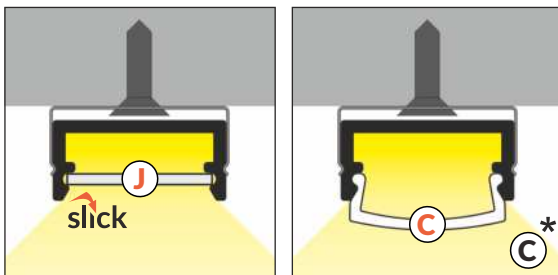
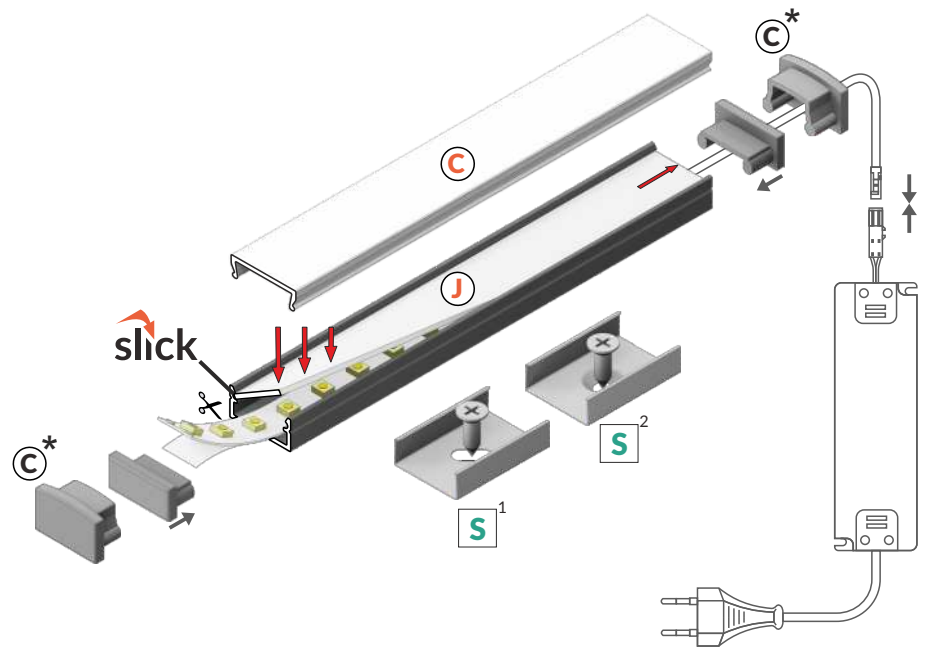



 max 12 mm

 surface



INDEX = 1 pc, length 2000 mm
package = 10 pcs

 white painted
C7020001

 anodized
C7020020

 black anodized
C7020021

 raw aluminium
C7020000

Available lengths: 1000 mm, 2000 mm, 3000 mm, 4000 mm.
The standard profile length tolerance is +2 mm.
For more details please see page 1.08.

ACCESSORIES

COVERS

J slide cover
 colours: transparent, frosted, opal
 material: PC, PP, PP



Note! Dimensions of the space to install LED source

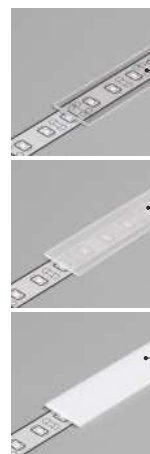
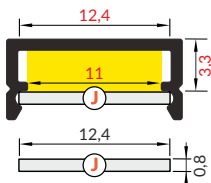

INDEX = 1 pc, length 2000 mm
 package = 10 pcs

J transparent
 70330016

J frosted
 70330039

J opal
 70330038

The standard cover length tolerance is +20 mm.
 For more details please see page 1.08.

ENDINGS

BEGTON12 ending
 colours: white, silver, black, grey
 material: ABS

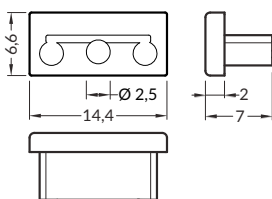

Ending with marked space to bore the holes.

BEGTON12 C ending
 colours: white, silver, black, grey
 material: ABS

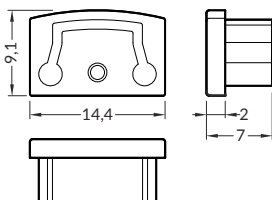

INDEX = 1 set
 package = 10 sets = 20 pcs

-  white C7960001
-  silver C7960040
-  black C7960002
-  grey C7960022

-  white C7940001
-  silver C7940040
-  black C7940002
-  grey C7940022

MOUNTINGS

S flexible mounting plate
 colours: white, inox, black
 material: stainless steel

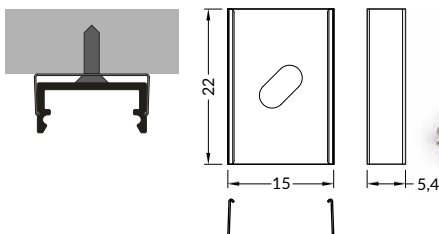

INDEX = 1 set
 package = 10 sets = 20 pcs

-  white C7980001
-  inox C7980019
-  black C7980002

cone S flexible mounting plate
 colours: white, inox, black
 material: stainless steel

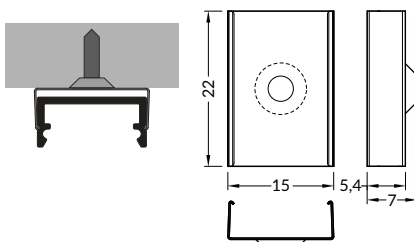

-  white C7950001
-  inox C7950019
-  black C7950002



UNI12 BCD/U

SURFACE AND RECESSED PROFILE

- 7 diffusers to choose from
- increased radiation – it is possible to use a stronger LED strip
- maximum LED strip width: 12 mm



SIMILAR IN THE OFFER



DEEP10
BC/UX



GROOVE10
BC/UX



SURFACE10
BC/UX



BEGTON12
J/S



FLOOR12
K/U



GROOVE14
EF/TY



SURFACE14
EF/TY



- B** slide cover
- C** click cover
- C** lens cover
- D** click cover
- U**¹ U flexible mounting plate
- U**² cone U flexible mounting plate

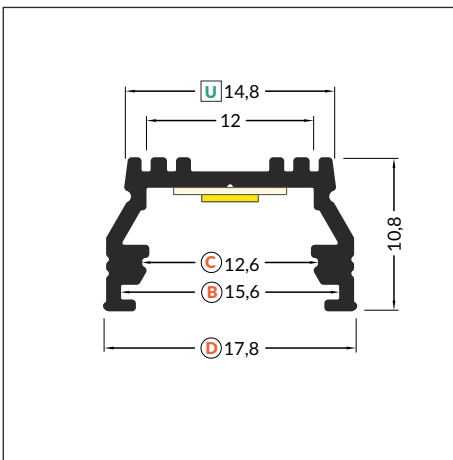
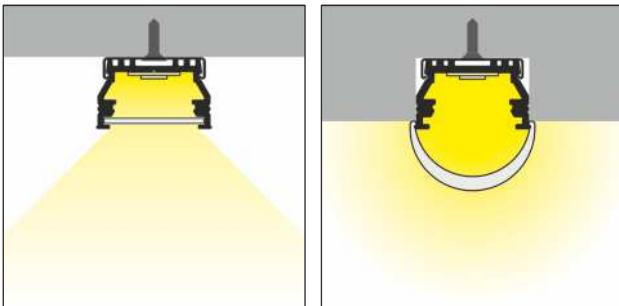
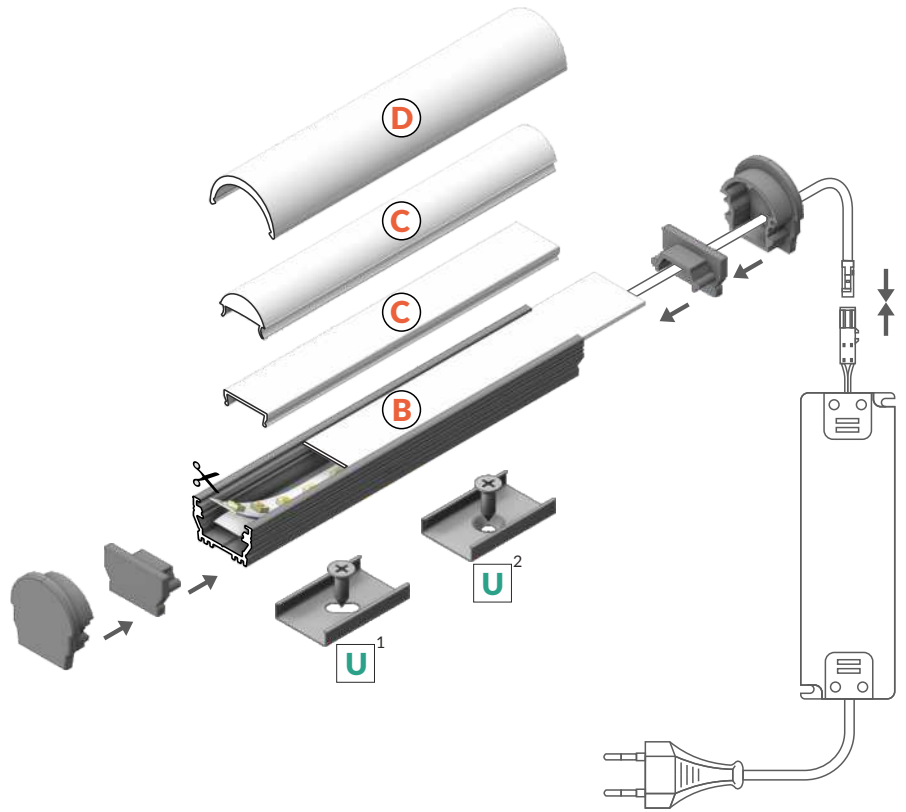

max 12 mm







surface



recessed



INDEX = 1 pc, length 2000 mm
package = 10 pcs

-  white painted
A1020001
-  anodized
A1020020
-  black anodized
A1020021
-  raw aluminium
A1020000

Available lengths: 1000 mm, 2000 mm, 3000 mm, 4000 mm.
The standard profile length tolerance is +2 mm.
For more details please see page 1.08.

ACCESSORIES

COVERS

B slide cover
 colours: transparent, frosted, opal
 material: PC, PP, PP



Note! Dimensions of the space to install LED source

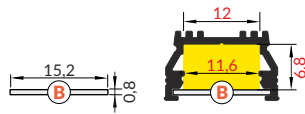

C click cover
 colours: transparent, opal
 material: PMMA

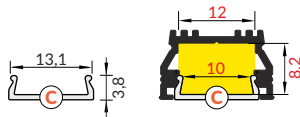

C lens click cover
 colour: transparent
 material: PC

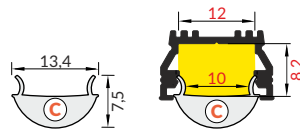

D click cover
 colour: opal
 material: PMMA

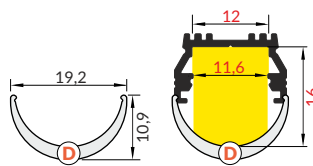

INDEX = 1 pc, length 2000 mm
 package = 10 pcs

B transparent
 76250016

B frosted
 76250039

B opal
 76250038

C transparent
 76330000

C opal
 76330038

C lens
 76300000

D opal
 A1140038

The standard cover length tolerance is +20 mm.
 For more details please see page 1.08.

MOUNTINGS

U flexible mounting plate
 colour: inox
 material: stainless steel

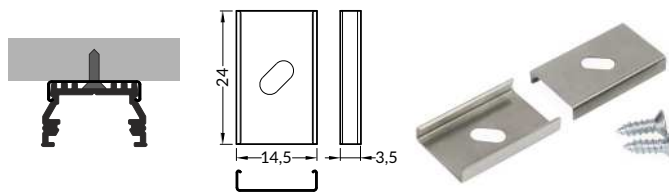

cone **U** flexible mounting plate
 colour: inox
 material: stainless steel

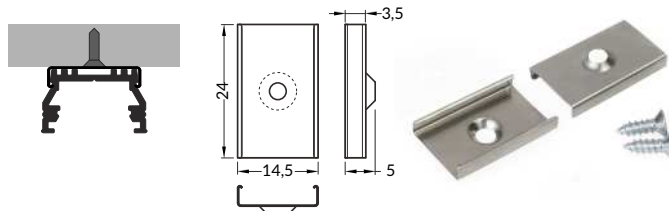

INDEX = 1 set
 package = 10 sets = 20 pcs

U flexible mounting plate

inox 76380000

cone **U** flexible mounting plate

inox 76620000

CONNECTORS

UNI12 connector 90 deg
 colours: white, anodized, black
 material: aluminium

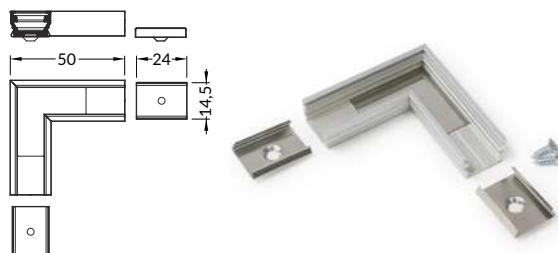

INDEX = 1 set

white painted

A1910001

anodized

A1910020

black anodized

A1910021

ACCESSORIES

ENDINGS

UNI12 ending gen2
 colours: white, silver, black, grey
 material: ABS

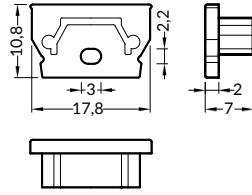

UNI12 ending gen2 with hole
 colours: white, silver, black, grey
 material: ABS

UNI12 D ending
 colours: white, silver, black, grey
 material: ABS

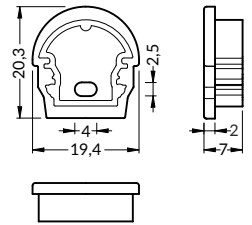

UNI12 D ending with hole
 colours: white, silver, black, grey
 material: ABS

INDEX = 1 set
 package = 10 sets = 20 pcs

○ white
 with hole | without hole
 A1890001 | A1900001

● silver
 with hole | without hole
 A1890040 | A1900040

● black
 with hole | without hole
 A1890002 | A1900002

● grey
 with hole | without hole
 A1890022 | A1900022

○ white
 with hole | without hole
 A1960001 | A1940001

● silver
 with hole | without hole
 A1960040 | A1940040

● black
 with hole | without hole
 A1960002 | A1940002

● grey
 with hole | without hole
 A1960022 | A1940022



SURFACE14 EF/TY

ALUMINIUM SURFACE PROFILE

- hidden mounting
- maximum LED strip width: 14 mm

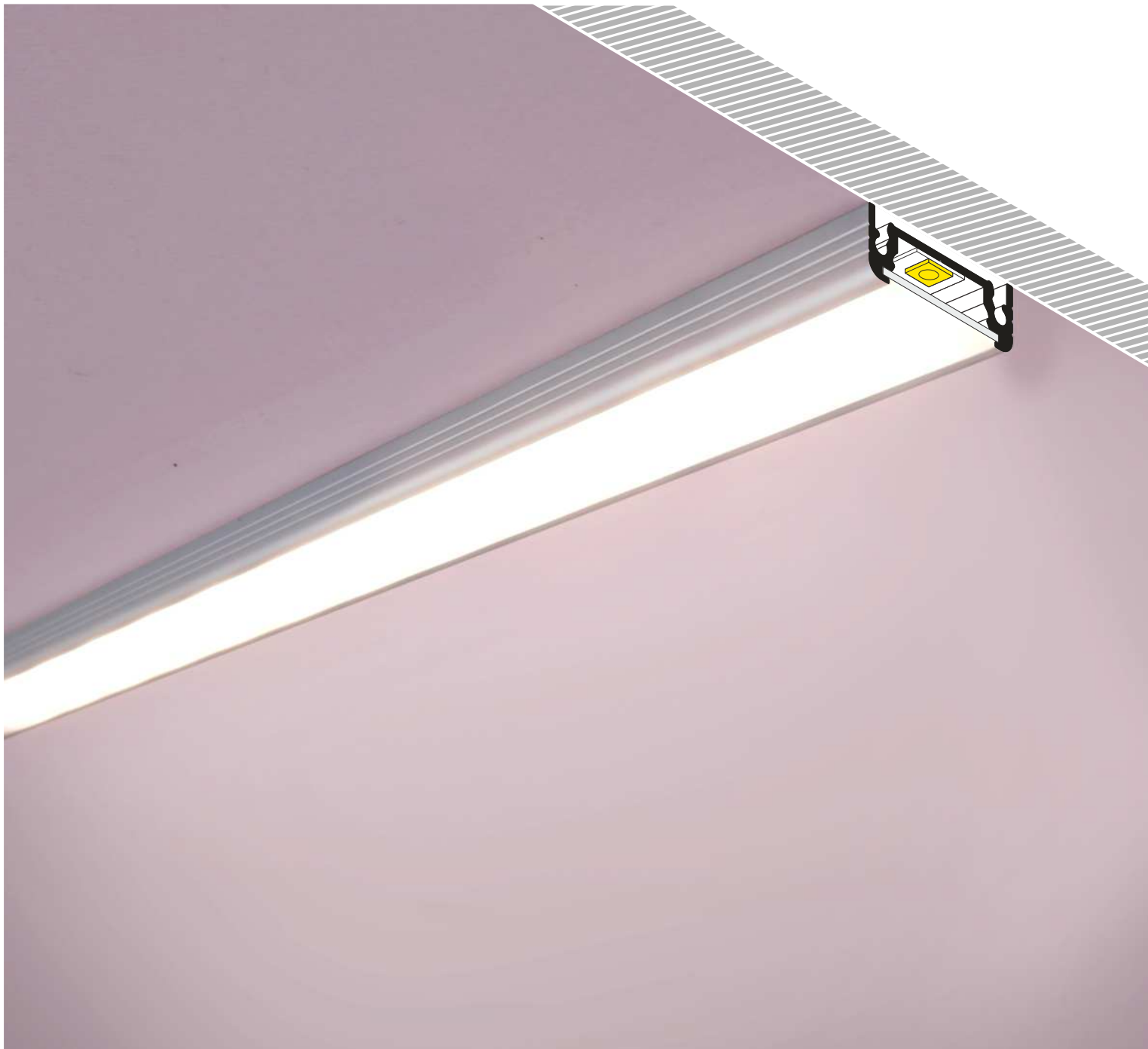

SIMILAR IN THE OFFER



SLIM8
A/Z



SMART10
A/Z



SURFACE10
BC/UX



LINEA20
EF/TY







WIDE24
G/W

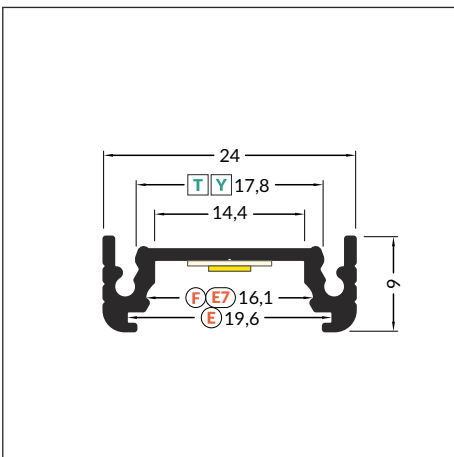
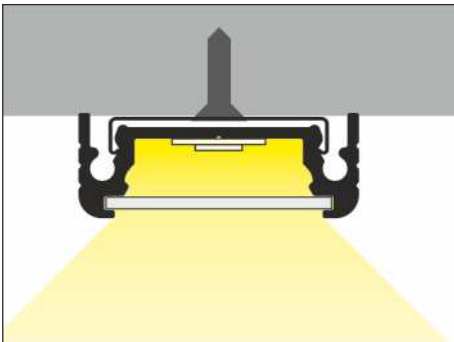
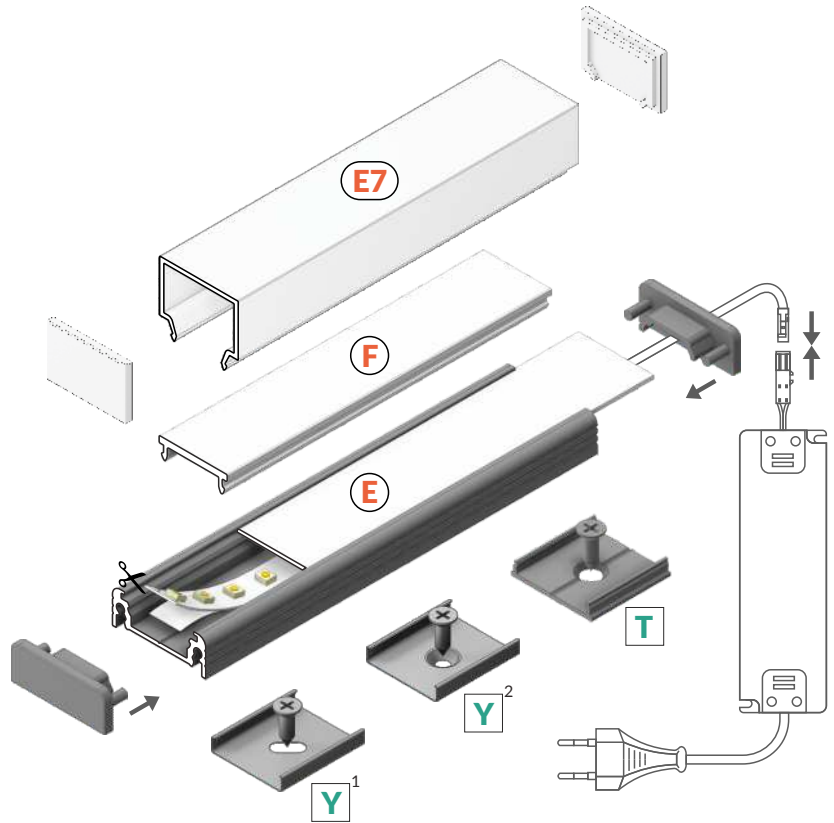

- E** slide cover
- F** click cover
- E7** E7 click cover
- Y¹** Y flexible mounting plate
- Y²** cone Y flexible mounting plate
- T** T mounting plate



INDEX = 1 pc, length 2000 mm
package = 10 pcs

-  white painted
A2020001
-  anodized
A2020020
-  black anodized
A2020021
-  raw aluminium
A2020000

Available lengths: 1000 mm, 2000 mm, 3000 mm, 4000 mm.
The standard profile length tolerance is +2 mm.
For more details please see page 1.08.

ACCESSORIES

COVERS

E slide cover
 colours: transparent, frosted, opal
 material: PC, PP, PP



Note! Dimensions of the space to install LED source

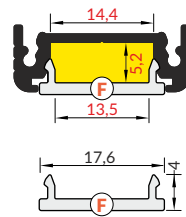
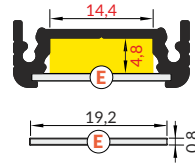

F click cover
 colours: transparent, opal
 material: PMMA

E7 click cover
 colour: opal
 material: PMMA

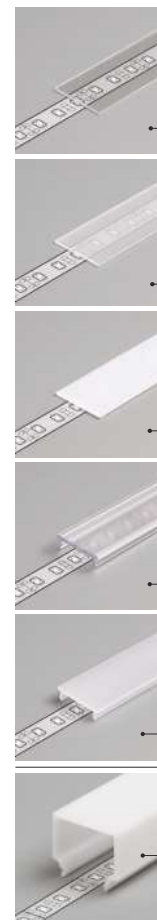
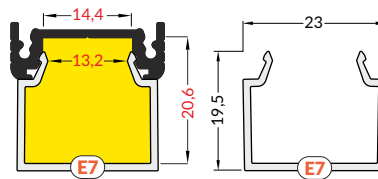

INDEX = 1 pc, length 2000 mm
 package = 10 pcs

E transparent
 A2040016

E frosted
 A2040039

E opal
 A2040038

F transparent
 A2060016

F opal
 A2060038

E7 opal
 C1080038

The standard cover length tolerance is +20 mm.
 For more details please see page 1.08.

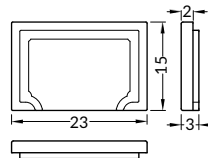

INDEX = 1 set
 package = 10 sets = 20 pcs

E7 opal ending
 E7
 C1840038

MOUNTINGS

Y flexible mounting plate
 colour: inox
 material: stainless steel

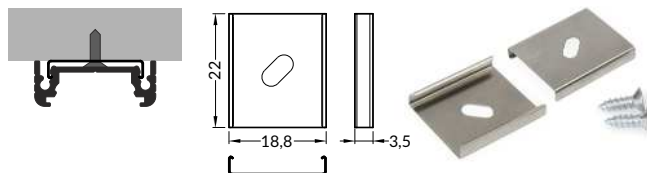

cone Y flexible mounting plate
 colour: inox
 material: stainless steel

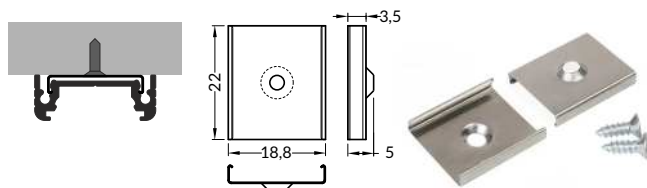

T mounting plate
 colour: raw aluminium
 material: aluminium

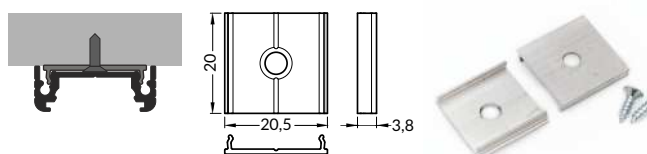

INDEX = 1 set
 package = 10 sets = 20 pcs

Y flexible mounting plate

inox A2090019

cone Y flexible mounting plate

inox A2130019

T mounting plate

raw aluminium
 C6960000

ACCESSORIES

ENDINGS

SURFACE14 ending gen2
colours: white, silver, black, grey
material: ABS

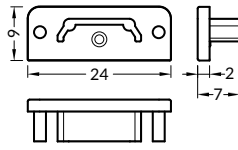

SURFACE14 ending gen2 with hole
colours: white, silver, black, grey
material: ABS

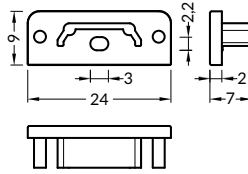

INDEX = 1 set
package = 10 sets = 20 pcs

○ white	
with hole	without hole
A2970001	A2980001
● silver	
with hole	without hole
A2970040	A2980040
● black	
with hole	without hole
A2970002	A2980002
● grey	
with hole	without hole
A2970022	A2980022

CONNECTORS

T connector 180 deg
colour: raw aluminium
material: aluminium

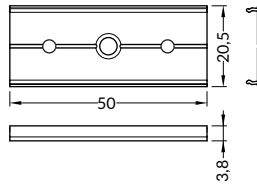

SURFACE14 connector 90 deg
colours: white, anodized, black
material: aluminium

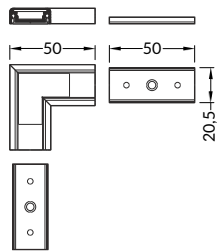

INDEX = 1 set

T connector

● raw aluminium
C6990000

connector 90 deg

○ white painted	
A2990001	
● anodized	
A2990020	
● black anodized	
A2990021	



SMART16 B/U4



ECONOMICAL PROFILE FOR 16 mm LED STRIP

- SLICK socket - easy assembly technology
- 2 channels for mounting bracket (with or without mounting surface distance)
- continuous line of light (when using LED strip 120 P/m and opal cover)
- maximum width of LED strip: 16 mm



SIMILAR IN THE OFFER





- B** slide cover
- U4¹** U4 mounting plate
- U4²** cone U4 mounting plate

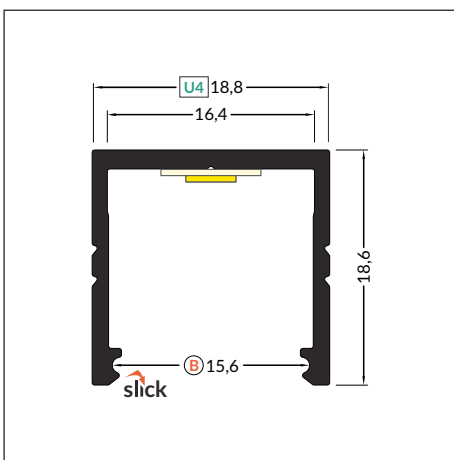
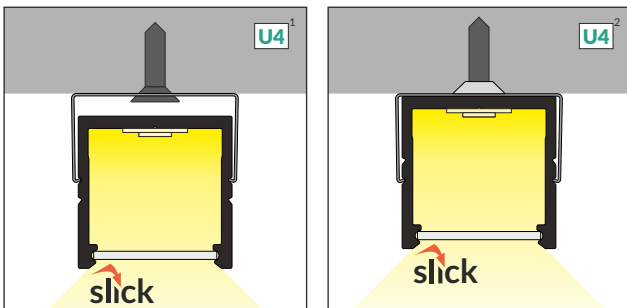
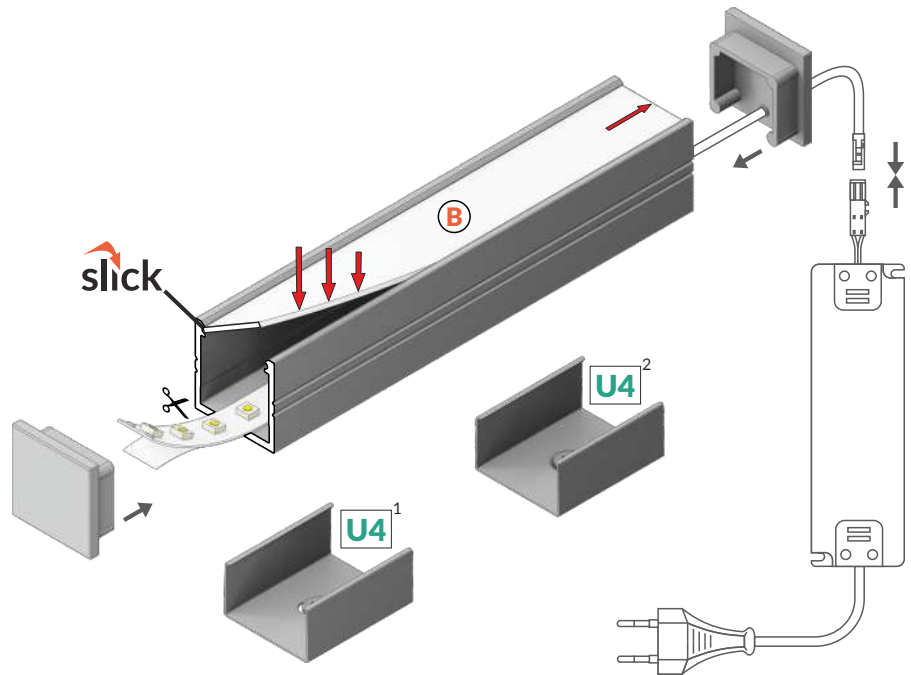

INDEX = 1 pc, length 2000 mm
package = 10 pcs

-  white painted
F1020001
-  anodized
F1020020
-  black anodized
F1020021
-  raw aluminium
F1020000

Available lengths: 1000 mm, 2000 mm, 3000 mm, 4000 mm.
The standard profile length tolerance is +2 mm.
For more details please see page 1.08.

 max 16 mm

 surface

ACCESSORIES

COVERS

B slide cover
 colours: transparent, frosted, opal
 material: PC, PP, PP

Note! Dimensions of the space to install LED source

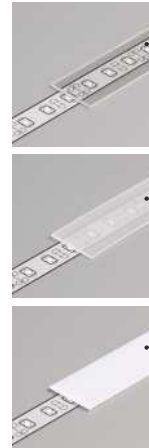
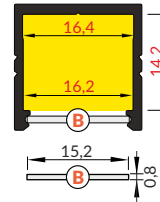

INDEX = 1 pc, length 2000 mm
 package = 10 pcs

B transparent
 76250016

B frosted
 76250039

B opal
 76250038

The standard cover length tolerance is +20 mm.
 For more details please see page 1.08.

ENDINGS

SMART16 ending
 colours: white, silver, black, grey
 material: ABS

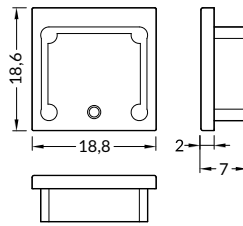

Ending with marked space to bore the holes.

INDEX = 1 set
 package = 10 sets = 20 pcs

white
 F1990001

silver
 F1990040

black
 F1990002

grey
 F1990022

MOUNTINGS

U4 mounting plate
 colours: white, inox, black
 material: stainless steel

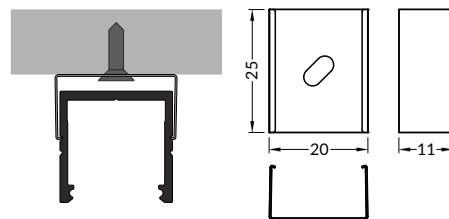

INDEX = 1 set
 package = 10 sets = 20 pcs

U4 mounting plate

white F1970001

inox F1970019

black F1970002

cone **U4 mounting plate**
 colours: white, inox, black
 material: stainless steel

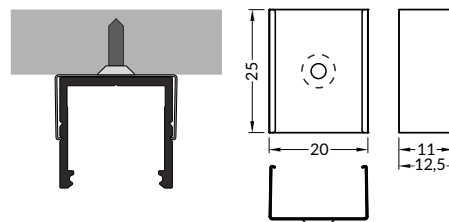

cone U4 mounting plate

white F1980001

inox F1980019

black F1980002



LINEA20 EF/TY

EFFICIENT LUMINAIRE CUT TO SIZE

- over 20 accessories available
- possibility of suspension along with the power supply
- LED modules are assembled with extra clamps
- angled connections illuminated
- continuous light line (with 120 P/m LED strip and opal cover applied)
- maximum LED source width: 20 mm

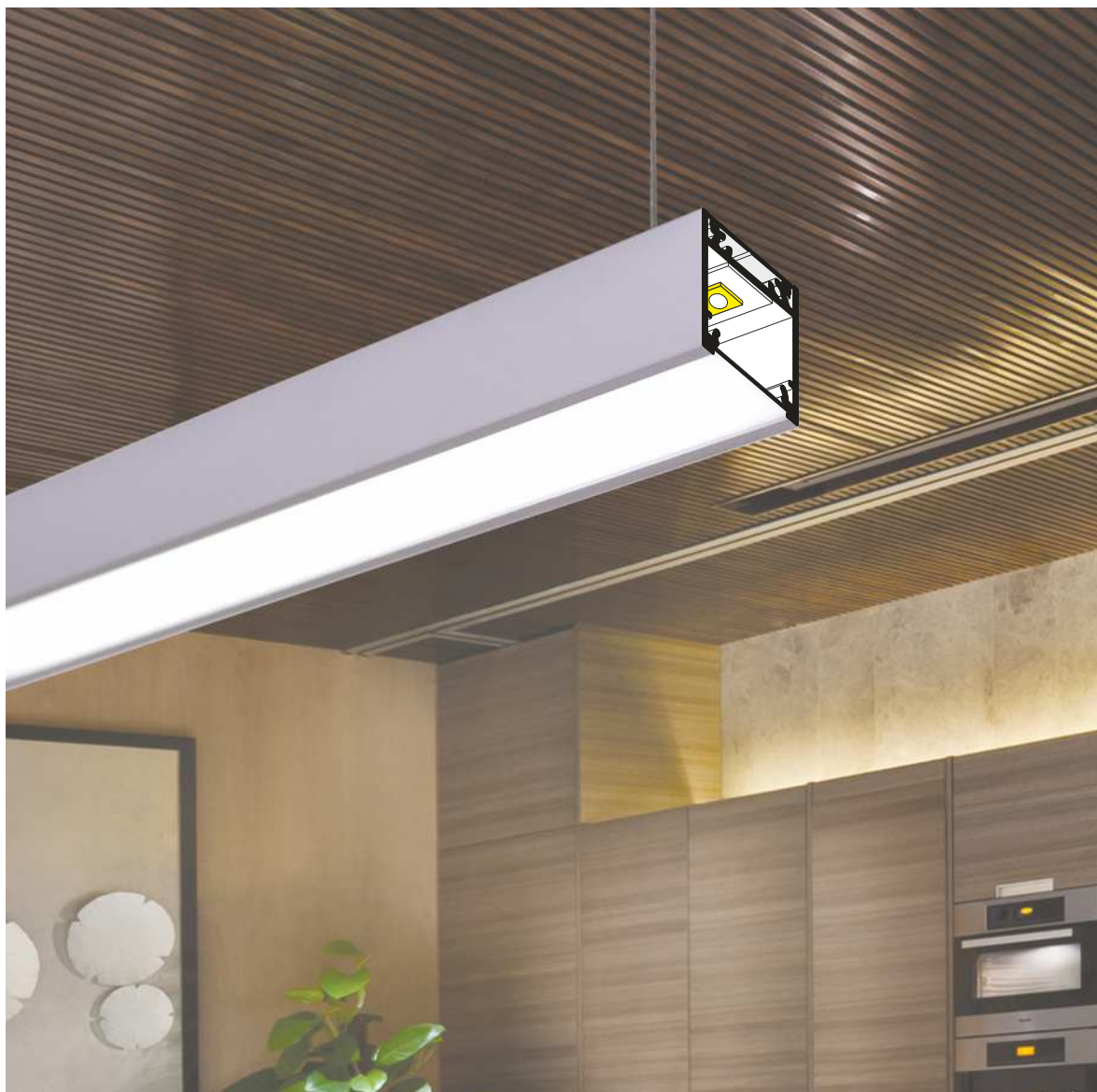

SIMILAR IN THE OFFER



LINEA-IN20
EF/U7



SURFACE14
EF/TY



WIDE24
G/W



VARIO30-01

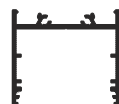

VARIO30-02



- E** slide cover
- F** click cover
- E7** E7 click cover
- Y¹** Y flexible mounting plate
- Y²** cone Y flexible mounting plate
- T** T mounting plate

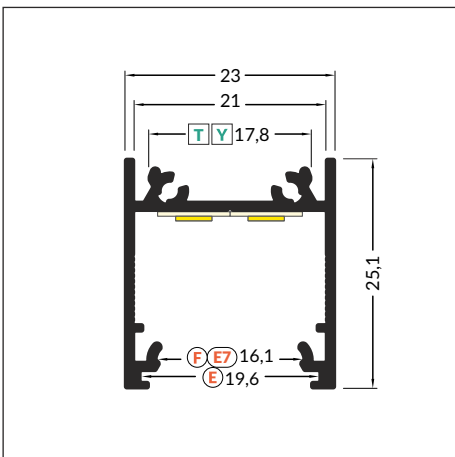
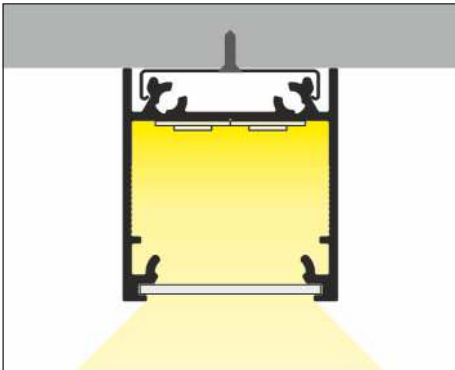
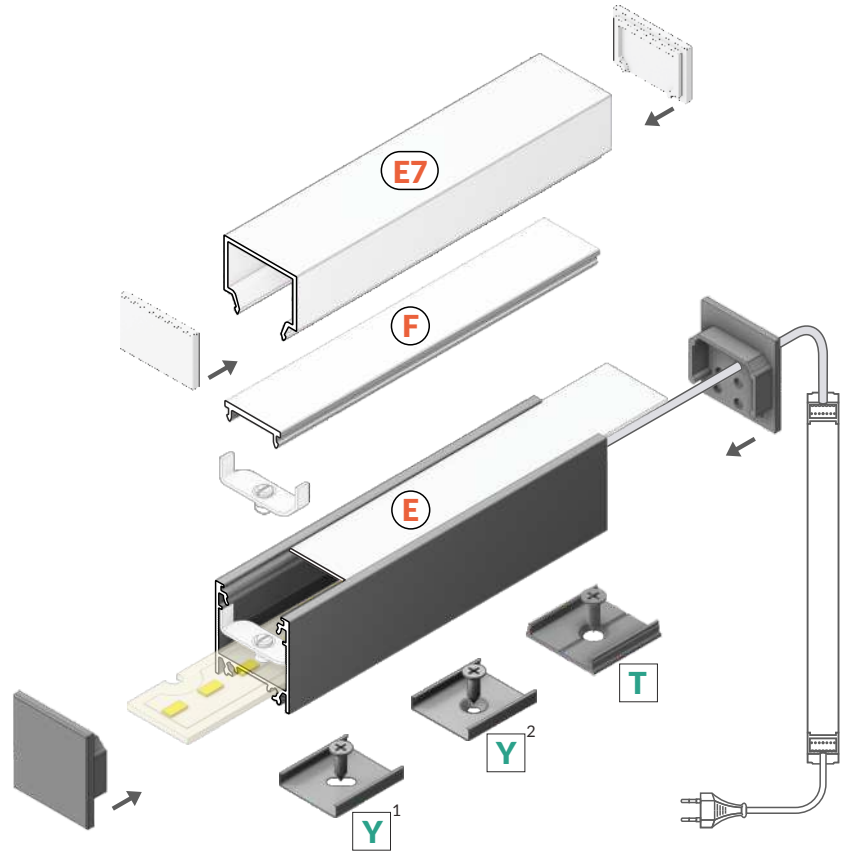

INDEX = 1 pc, length 2000 mm
package = 10 pcs

○ white painted
C1020001



● anodized
C1020020



● black anodized
C1020021



● raw aluminium
C1020000

Available lengths: 1000 mm, 2000 mm, 3000 mm, 4000 mm.
The standard profile length tolerance is +2 mm.
For more details please see page 1.08.

LINEA20 EF/TY



CONTINUOUS LIGHT LINE
The LINEA20 180° connector provides an aesthetic, continuous light line of any length.

ACCESSORIES

COVERS

E slide cover
 colours: transparent, frosted, opal
 material: PC, PP, PP



Note! Dimensions of the space to install LED source

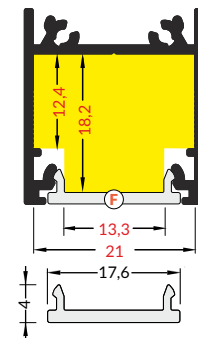
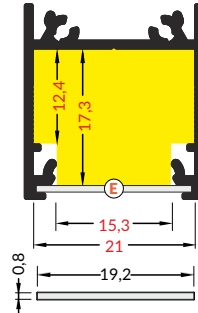

F click cover
 colours: transparent, opal
 material: PMMA

E7 click cover
 colour: opal
 material: PMMA

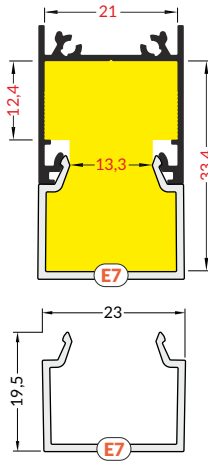

INDEX = 1 pc, length 2000 mm
 package = 10 pcs

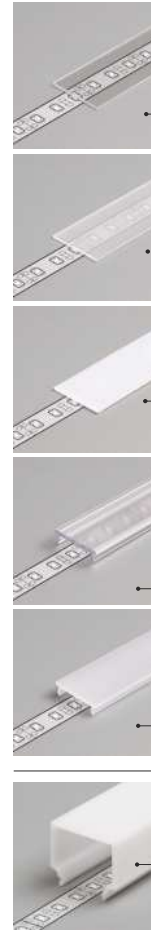

E transparent
 A2040016

E frosted
 A2040039

E opal
 A2040038

F transparent
 A2060016

F opal
 A2060038

E7 opal
 C1080038

The standard cover length tolerance is +20 mm.
 For more details please see page 1.08.

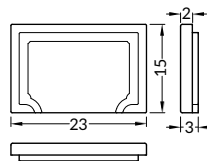

INDEX = 1 set
 package = 10 sets = 20 pcs

E7 opal ending

C1840038

ACCESSORIES

LED MOUNTING

LINEA20 LED mounting
material: aluminium

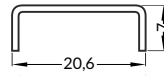

INDEX = 1 pc, length 2000 mm
package = 10 pcs

● raw aluminium
C6060000

LIGHTING EFFECT

LINEAE20 LED mounting + LINEA20-1 LED clamp



Lighting effect without LINEA20 LED mounting

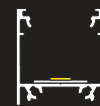

ACCESSORIES

CLAMP

LINEA20 LED clamp
 colour: white
 material: painted steel, plastic

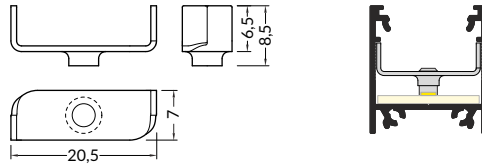

LINEA20-1 LED clamp
 colour: white
 material: painted steel, plastic

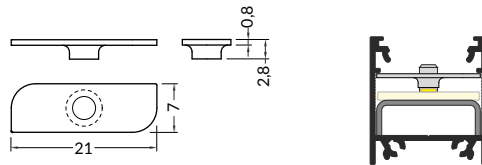

INDEX = 1 set
 package = 10 sets = 20 pcs

○ white C6940001

○ white C6930001

ENDINGS

LINEA20 ending
 colours: white, silver, black, grey
 material: ABS

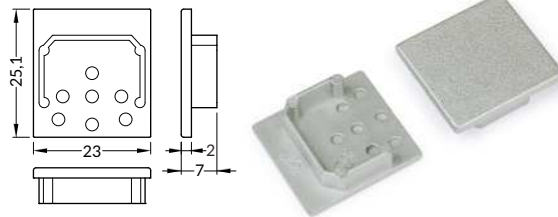

Ending with marked space to bore the holes.
 Possibility of buying dedicated screws.

INDEX = 1 set
 package = 10 sets = 20 pcs

○ white C1940001

● silver C1940040

● black C1940002

● grey C1940022

screws for LED endings
 colours: white, silver, black, inox



INDEX = 1 set
 package = 10 sets = 40 pcs

○ white B1900001

● silver B1900040

● black B1900002

● inox inox B1900019

LINEA20 EF/TY

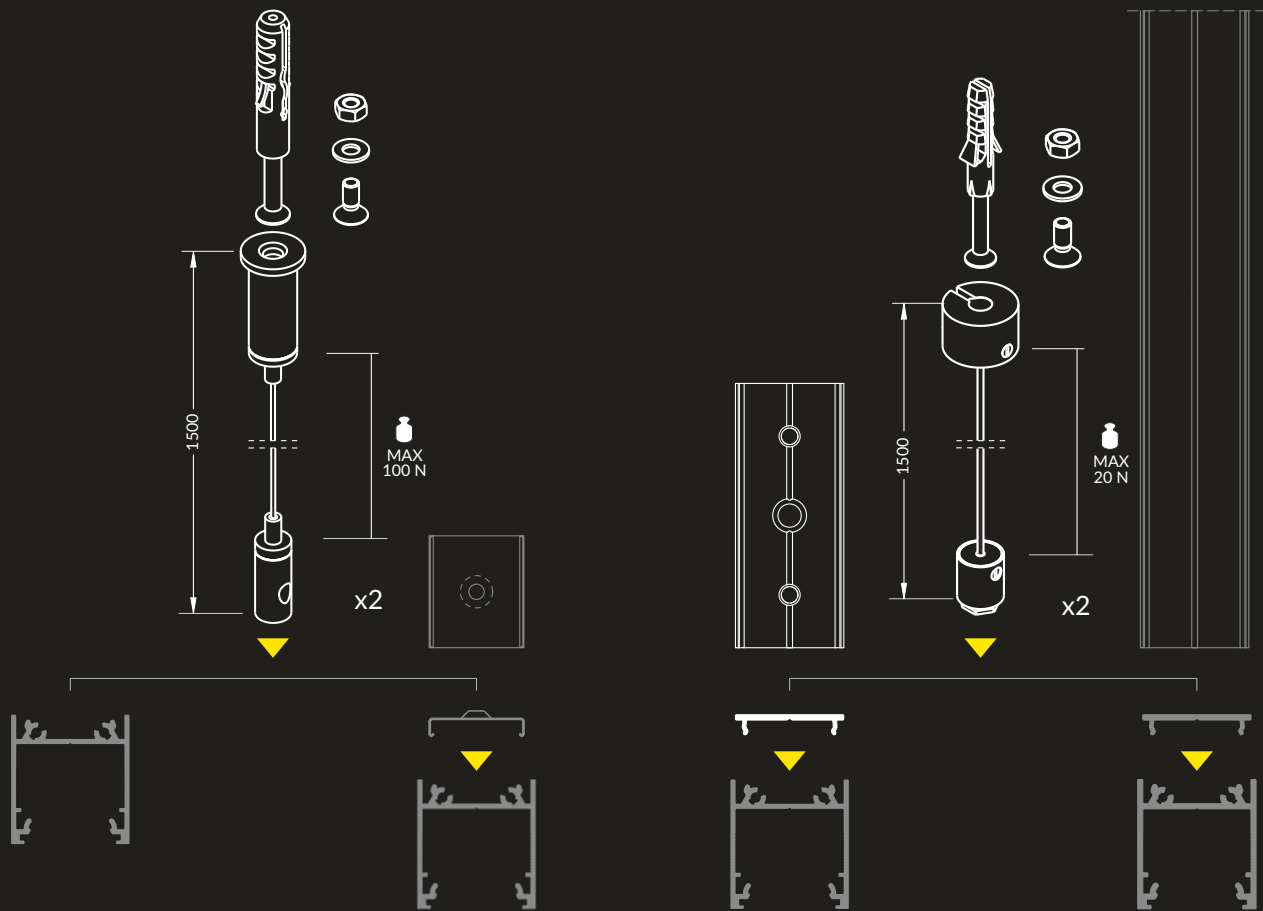

SLING FOR LED MOUNTING 1500

Compatible with flexible mounting plates, allows fast and easy assembly of the luminaire. Possibility of direct mounting to the profile.



SELV SLING 50 V 1500

It provides a minimalistic look – no additional wires required.



Using FIX16 profile creates an aesthetic, closed from the top, luminaire.

Drill Ø 5 mm mounting holes in FIX16

ACCESSORIES

MOUNTINGS

Y flexible mounting plate
 colour: inox
 material: stainless steel

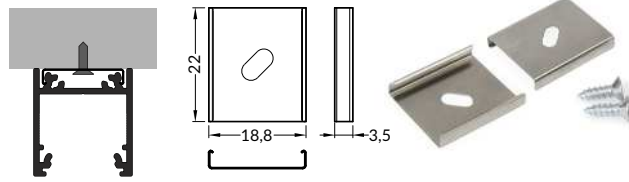

cone Y flexible mounting plate
 colour: inox
 material: stainless steel

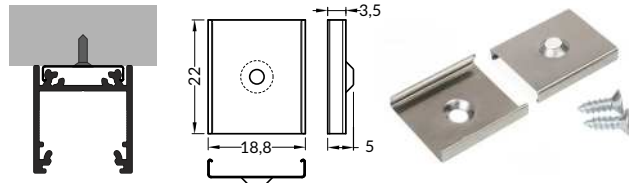

T mounting plate
 colour: raw aluminium
 material: aluminium

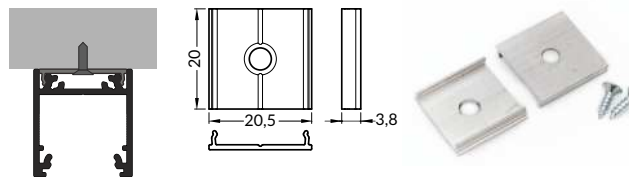

INDEX = 1 set
 package = 10 sets = 20 pcs

Y flexible mounting

● inox A2090019

cone Y flexible mounting plate

● inox A2130019

T mounting plate

● raw aluminium
 C6960000

ALUMINIUM COVER

LED profile FIX16
 colours: white, anodized, black, raw aluminium
 material: aluminium

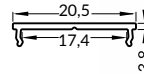

Available lengths: 1000 mm, 2000 mm, 3000 mm, 4000 mm.
 The standard profile length tolerance is +2 mm. For more details please see page 1.08.

INDEX = 1 pc, length 2000 mm
 package = 10 pcs

○ white painted
 C6020001

● anodized
 C6020020

● black anodized
 C6020021

● raw aluminium
 C6020000

SLING

SELV sling 50 V 1500
 colours: white, silver, black



INDEX = 1 set = 2 pcs

SELV sling 50 V 1500

○ white 67120001

● silver 67120022

● black 67120002

sling for LED mounting 1500
 colour: chrome



sling for LED mounting 1500

● chrome 67140003

LINEA20 EF/TY

CONNECTION POSSIBILITY



60°



90°



120°



135°



180°

ANGULAR CONNECTORS

Thanks to five different angle connectors (60° / 90° / 120° / 135° / 180°) it is possible to create many various lighting systems - with no need to cut the profile at an angle.

Bent connectors allows to connect profiles in two planes, at two angles: 90° on the inside and 270° on the outside.



The component made of clear fabric provides secure connection, letting light through at the same time. Thanks to that, the luminaire can illuminate on the entire surface of the cover - even in the corners.

ACCESSORIES

CONNECTORS

LINEA20 connector 60 deg
colours: white, anodized, black
material: aluminium, polycarbonate

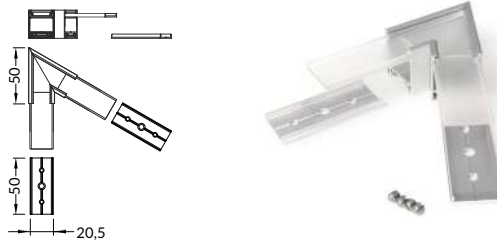

LINEA20 connector 90 deg
colours: white, anodized, black
material: aluminium, polycarbonate

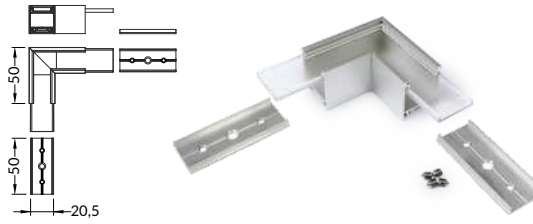

LINEA20 connector 90 deg bent
colours: white, anodized, black
material: aluminium, polycarbonate

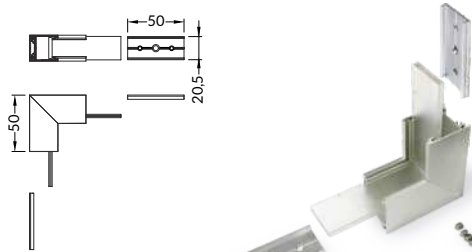

LINEA20 connector 120 deg
colours: white, anodized, black
material: aluminium, polycarbonate

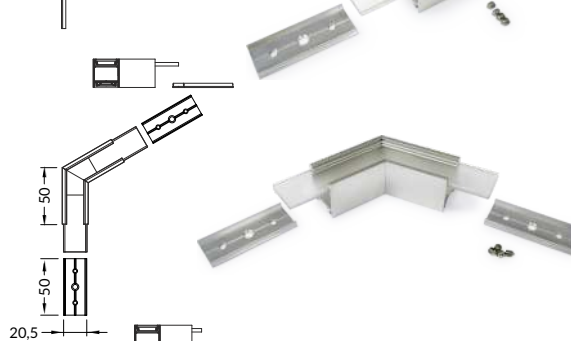

LINEA20 connector 135 deg
colours: white, anodized, black
material: aluminium, polycarbonate

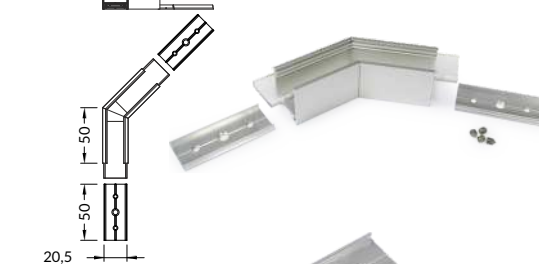

LINEA20 connector 180 deg
material: aluminium, polycarbonate



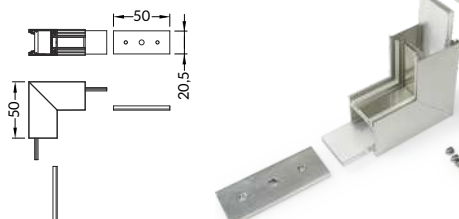

LINEA20 connector 270 deg bent
colours: white, anodized, black
material: aluminium, polycarbonate





INDEX = 1 set



connector 60 deg

-  white painted C1850001
-  anodized C1850020
-  black anodized C1850002



connector 90 deg

-  white painted C1860001
-  anodized C1860020
-  black anodized C1860002



connector 90 deg bent

-  white painted C1870001
-  anodized C1870020
-  black anodized C1870002

connector 120 deg

-  white painted C1880001
-  anodized C1880020
-  black anodized C1880002



connector 135 deg

-  white painted C1890001
-  anodized C1890020
-  black anodized C1890002

connector 180 deg

C1900000

connector 270 deg bent

-  white painted C1910001
-  anodized C1910020
-  black anodized C1910002

LINEA20 EF/TY





PENDANT LUMINAIRE

Thanks to wide range of profile accessories it could be applied in many arrangements. SELV sling 50 V 1500 and FIX16 closing profile allows to create pendant luminaire with a small intersection, but strong light.

WIDE, ALUMINIUM, SURFACE PROFILE

- possibility of installing 3 8 mm LED strips
- Slick socket
- maximum LED strip width: 24 mm



SIMILAR IN THE OFFER





G slide cover

W cone **W** flexible mounting plate

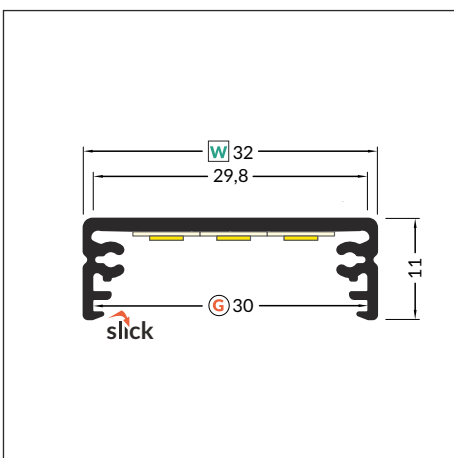
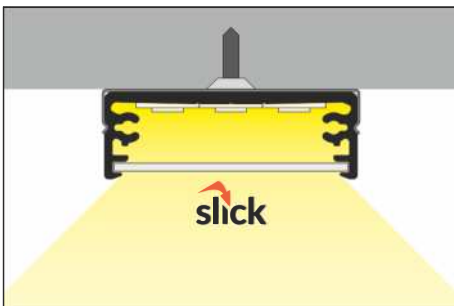
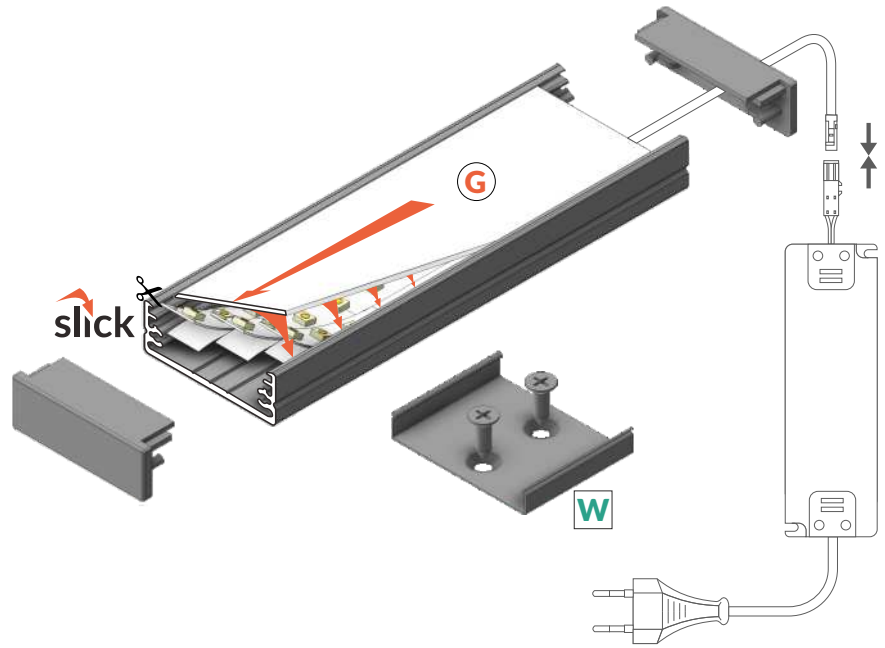

 max 24 mm

 surface



INDEX = 1 pc, length 2000 mm
package = 10 pcs

 white painted
84030001



 anodized
84030020



 black anodized
84030021



 raw aluminium
84030000

Available lengths: 1000 mm, 2000 mm, 3000 mm, 4000 mm.
The standard profile length tolerance is +2 mm.
For more details please see page 1.08.

ACCESSORIES

COVERS

G slide cover
 colours: transparent, frosted, opal
 material: PC, PP, PP



Note! Dimensions of the space to install LED source

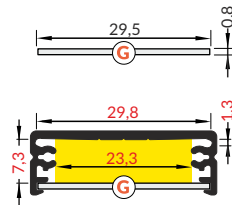

INDEX = 1 pc, length 2000 mm
 package = 10 pcs

G transparent
 84070016

G frosted
 84070039

G opal
 84070038

The standard cover length tolerance is +20 mm.
 For more details please see page 1.08.

ENDINGS

WIDE24 ending
 colours: white, silver, black, grey
 material: ABS

WIDE24 ending with hole
 colours: white, silver, black, grey
 material: ABS

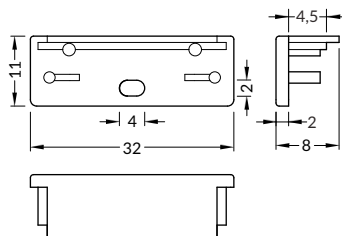

INDEX = 1 set
 package of 10 sets = 20 pcs

○ white
 with hole | without hole
 84300001 | 84040001

● silver
 with hole | without hole
 84300040 | 84040040

● black
 with hole | without hole
 84300002 | 84040002

● grey
 with hole | without hole
 84300022 | 84040022

MOUNTINGS

cone **W** flexible mounting plate
 colour: white, inox, black
 material: stainless steel

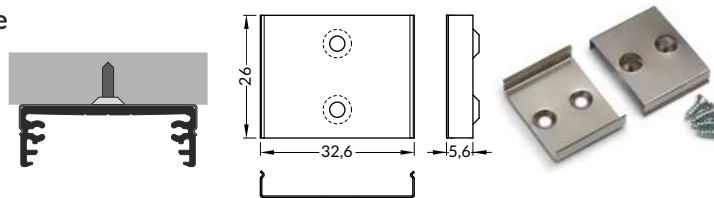

INDEX = 1 set
 package of 10 sets = 20 pcs

cone **W** flexible mounting plate

○ white 84510001

● inox inox 84510019

● black 84510002

WIDE24 simple holder
 material: zinc coated steel

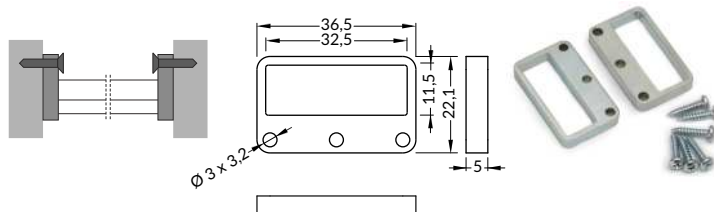

INDEX = 1 set = 2 pcs .

simple holder

● zinc coated
 84220030

ACCESSORIES

SLING

SELV sling 50 V 1500

colours: white, silver, black

sling for LED mounting 1500
colour: chrome



INDEX = 1 set = 2 pcs

SELV sling 50 V 1500

○ white 67120001

● silver 67120022

● black 67120002

sling for LED mounting 1500

● chrome 67140003



FLAT8 H/UX

FLAT RECESSED PROFILE EMITTING DIFFUSED LIGHT GLOW

- decorative illumination
- a parabolic, reflecting element - even, smooth, diffused light
- a flat profile, designed to fit into plasterboards - installation without interference in the frame construction
- mounted to furniture, walls, pedestals with holders (click-in) or directly (with screws, adhesive tape or glue)
- maximum LED strip width: 8 mm



SIMILAR IN THE OFFER

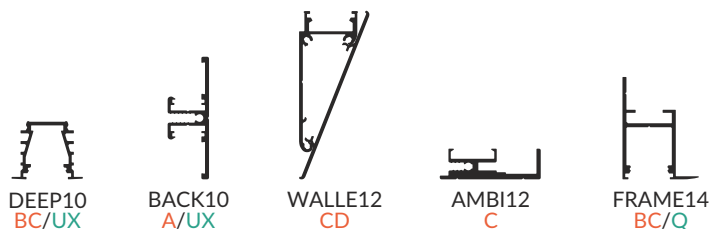



H H slide cover

U¹ U flexible mounting plate

U² cone U flexible mounting plate

X¹ X mounting plate

X² spring X mounting plate

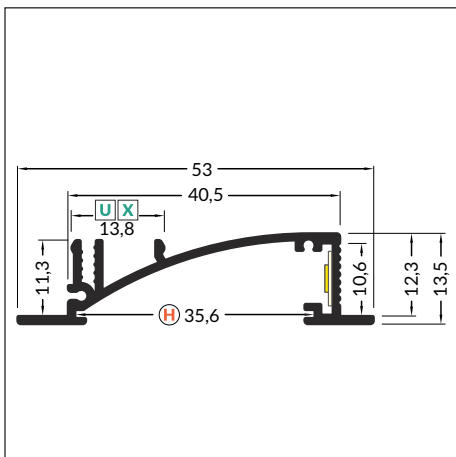
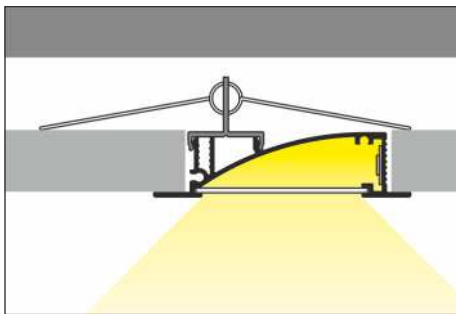
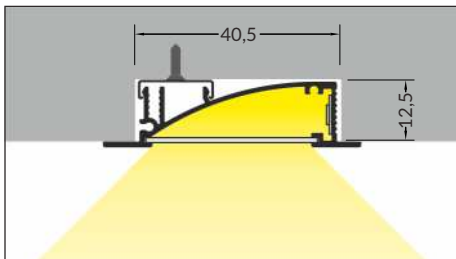
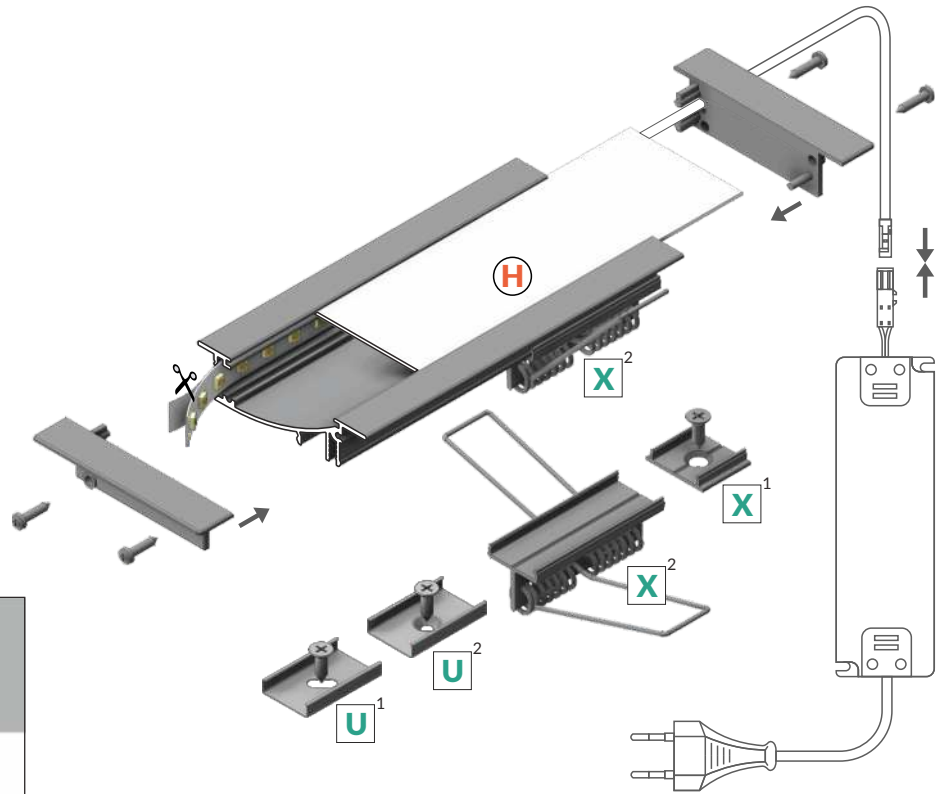

max 8 mm

recessed



INDEX = 1 pc, length 2000 mm
package = 10 pcs

white painted
23050001



anodized
23050020



black anodized
23050021



raw aluminium
23050000

Available lengths: 1000 mm, 2000 mm, 3000 mm, 4000 mm.
The standard profile length tolerance is +2 mm.
For more details please see page 1.08.

ACCESSORIES

COVERS

H slide cover
 colours: transparent, frosted, opal
 material: PC, PP, PP



Note! Dimensions of the space to install LED source

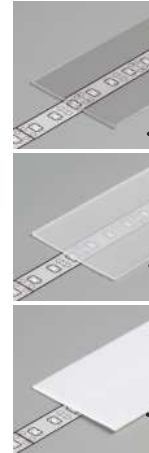
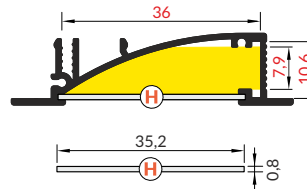

INDEX = 1 pc, length 2000 mm
 package = 10 pcs

H transparent
 23080016

H frosted
 23080039

H opal
 23080038

The standard cover length tolerance is +20 mm.
 For more details please see page 1.08.

ENDINGS

FLAT8 ending with hole
 colours: white, silver, black, grey
 material: ABS

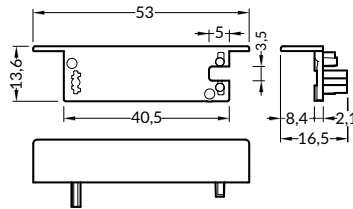

INDEX = 1 set
 package = 10 sets = 20 pcs

○ white 23110001

● silver 23110040

● black 23110002

● grey 23110022

MOUNTINGS

U flexible mounting plate
 colour: inox
 material: stainless steel

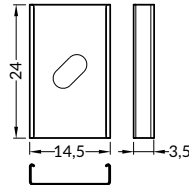
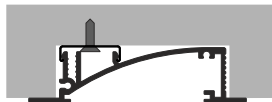

U flexible mounting plate

● inox
 76380000

cone **U** flexible mounting plate
 colour: inox
 material: stainless steel

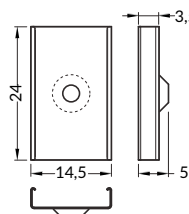
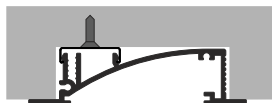

cone **U** flexible mounting plate

● inox
 76620000

X mounting plate
 colour: raw aluminium
 material: aluminium

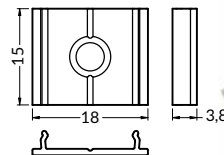
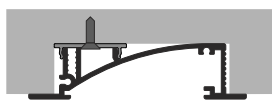

X mounting plate

● raw aluminium
 76260000

spring **X** mounting plate
 colour: raw aluminium
 material: aluminium

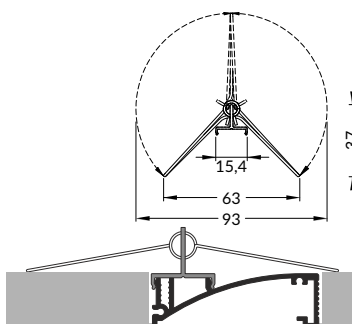

INDEX = 1 pc

spring **X** mounting plate

● raw aluminium
 23130000

ACCESSORIES

CONNECTORS

X connector 180 deg
colour: raw aluminium
material: aluminium

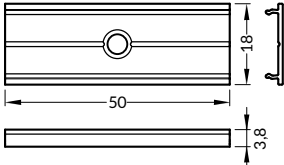

INDEX = 1 set

raw aluminium
76350000



HI8 C1

THIN LINE OF LIGHT

- decorative illumination
- for counter edges, steps
- flushes with mounting surface
- only enlight surface of the cover is visible
- miniature dimensions
- maximum width of LED strip: 8 mm



SIMILAR IN THE OFFER



FLOOR12
K/U



SMART-IN10
A/Z



C1 C1 click cover

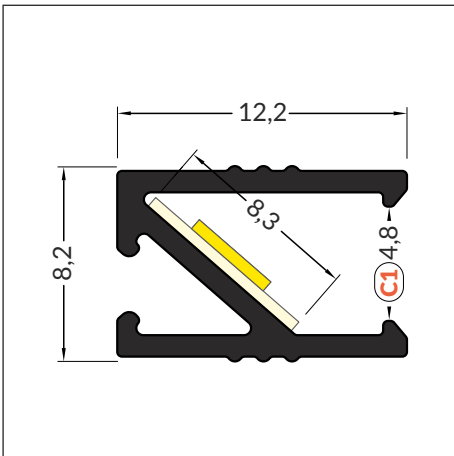
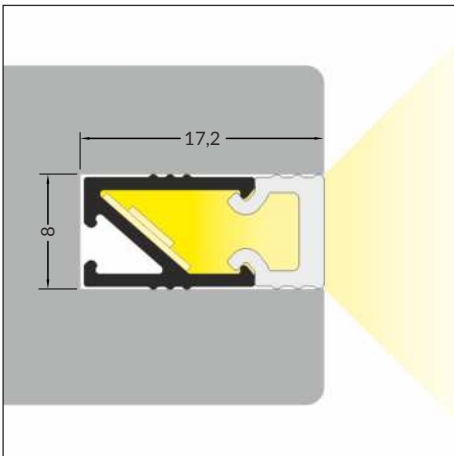
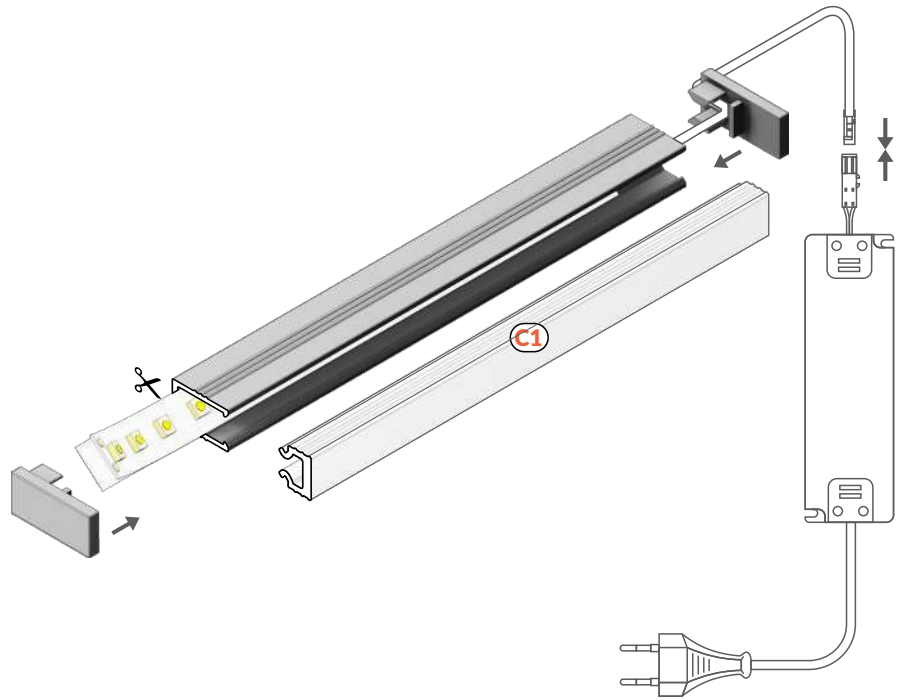

INDEX = 1 pc, length 2000 mm
package = 10 pcs



● anodized
H8020020

Available lengths: 1000 mm, 2000 mm, 3000 mm, 4000 mm.
The standard profile length tolerance is +2 mm.
For more details please see page 1.08.



max 8 mm



recessed

ACCESSORIES

COVERS

C1 click cover
 colour: opal
 material: PMMA



Note! Dimensions of the space to install LED source

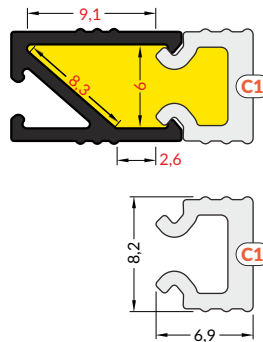

C1 opal
 H8060038

INDEX = 1 pc, length 2000 mm
 package = 10 pcs



The standard cover length tolerance is +20 mm.
 For more details please see page 1.08.

ENDINGS

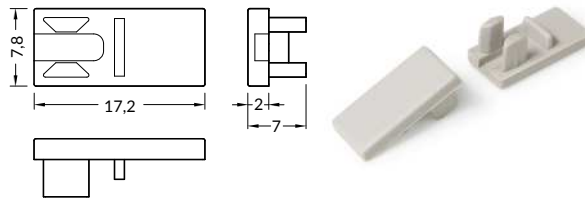
Hi8 ending
 colours: silver, grey, opal
 material: ABS, ABS, PMMA



INDEX = 1 set
 package = 10 sets = 20 pcs

-  silver H8990040
-  grey H8990022
-  opal H8990038



DEEP10 BC/UX

A RECESSED PROFILE WHICH CAN GIVE A CONTINUOUS LINE EFFECT

- mainly used in furniture or plasterboard
- continuous line of light (when using LED strip 120 P/m and opal cover)
- angled profile sides are designed for better light reflection
- maximum LED strip width: 10 mm

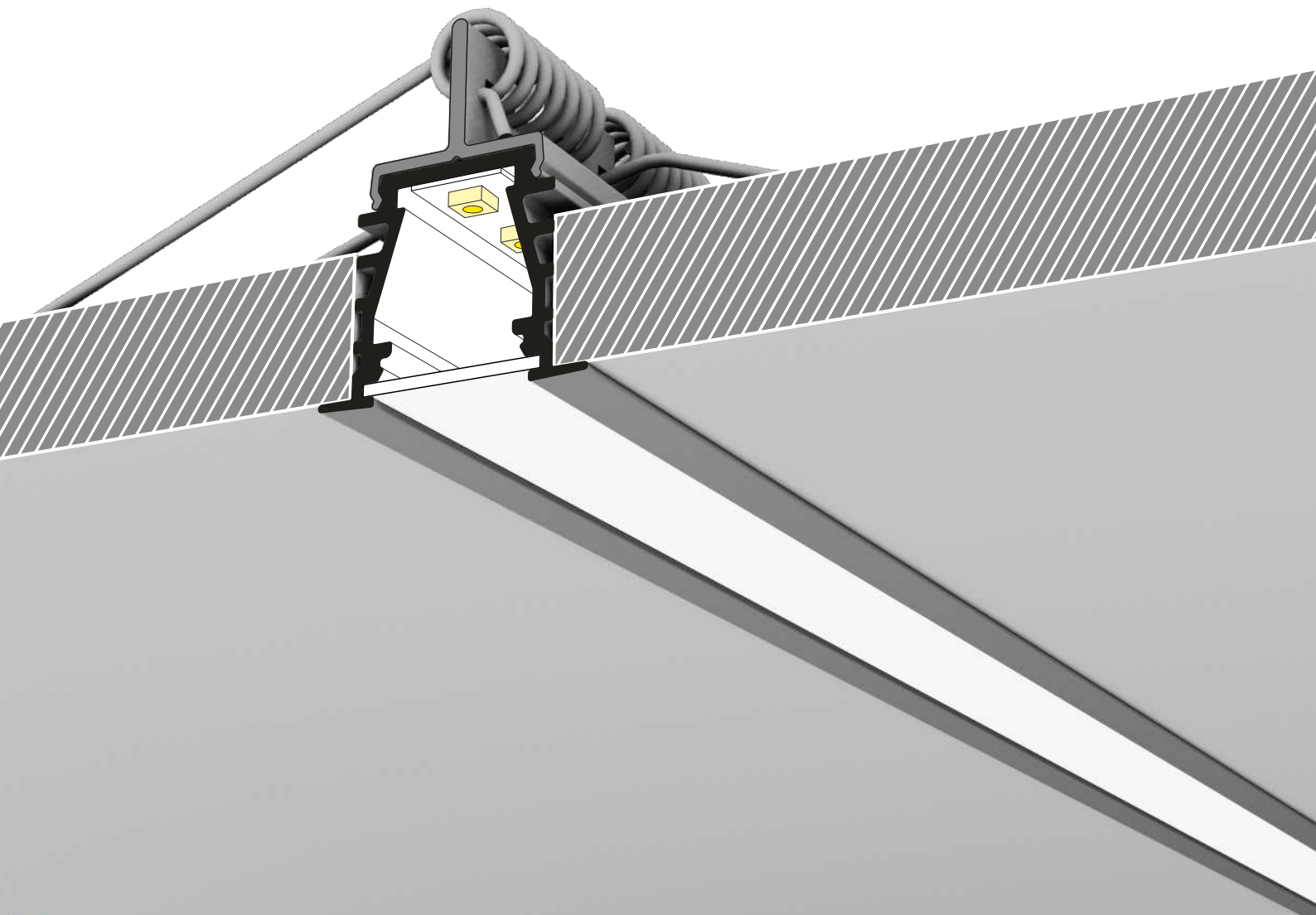

SIMILAR IN THE OFFER



FLAT8
H/UX



BEGTIN12
J/S



GROOVE10
BC/UX



UNI12
BCD/U



GROOVE14
EF/TY



B slide cover
B

C click cover
C

C lens cover
C

U¹ flexible mounting plate

U² cone U flexible mounting plate

U³ rack U flexible mounting plate

X¹ X mounting plate

X² spring X mounting plate

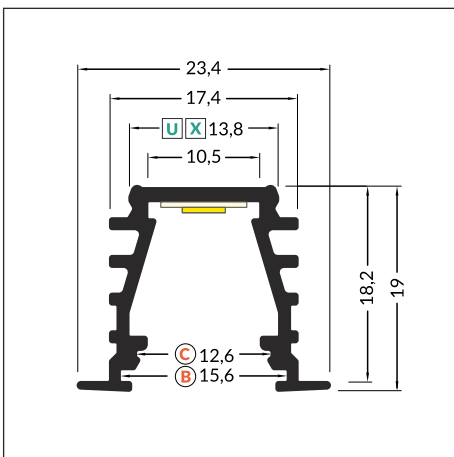
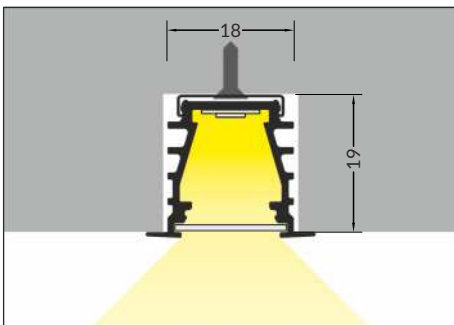
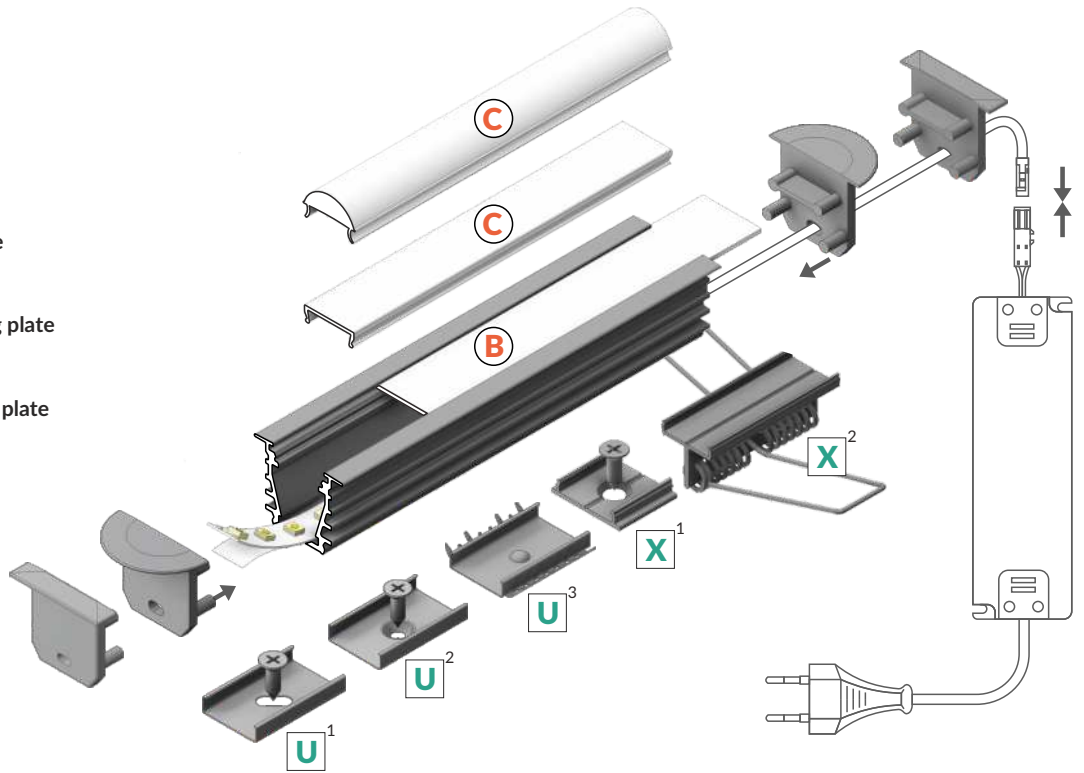

INDEX = 1 pc, length 2000 mm
package = 10 pcs

○ white painted
96030001

● anodized
96030020

● black anodized
96030021

● raw aluminium
96030000

max 10 mm

recessed

Available lengths: 1000 mm, 2000 mm, 3000 mm, 4000 mm.
The standard profile length tolerance is +2 mm.
For more details please see page 1.08.

ACCESSORIES



COVERS

B slide cover
 colours: transparent, frosted, opal
 material: PC, PP, PP



Note! Dimensions of the space to install LED source

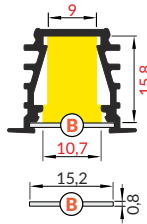

C click cover
 colours: transparent, opal
 material: PMMA

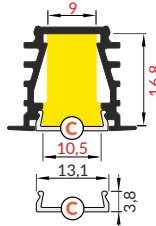

C lens click cover
 colour: transparent
 material: PC

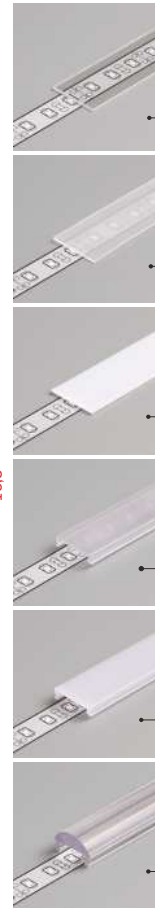
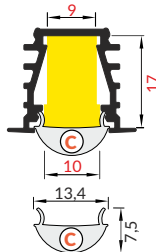

INDEX = 1 pc, length 2000 mm
 package = 10 pcs

B transparent
 76250016

B frosted
 76250039

B opal
 76250038

C transparent
 76330000

C opal
 76330038

C lens
 76300000

The standard cover length tolerance is +20 mm.
 For more details please see page 1.08.

ENDINGS

DEEP10 ending gen2 with hole
 colours: white, silver, black, grey
 material: ABS

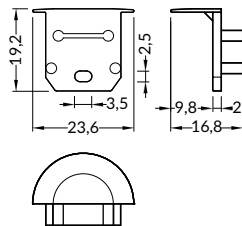

DEEP10 ending gen2 SQ with hole
 colours: white, silver, black, grey
 material: ABS

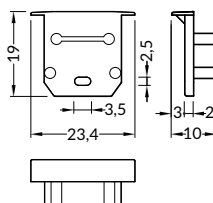

INDEX = 1 set
 package = 10 sets = 20 pcs

○ white 96980001

● silver 96980040

● black 96980002

● grey 96980022

○ white 96990001

● silver 96990040

● black 96990002

● grey 96990022

CONNECTORS

X connector 180 deg
 colour: raw aluminium
 material: aluminium

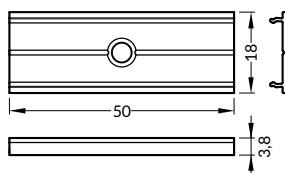

INDEX = 1 set

● raw aluminium
 76350000



MOUNTINGS

U flexible mounting plate
 colour: inox
 material: stainless steel

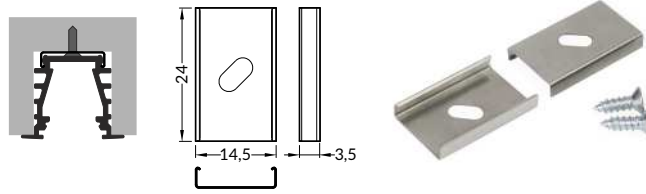

INDEX = 1 set
 package = 10 sets = 20 pcs

U flexible mounting plate

● inox
 inox
 76380000

cone U flexible mounting plate
 colour: inox
 material: stainless steel

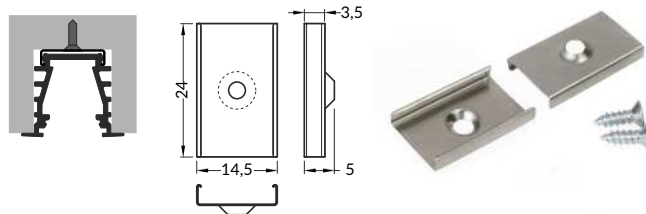

cone U flexible mounting plate

● inox
 76620000

rack U flexible mounting plate
 colour: inox
 material: stainless steel

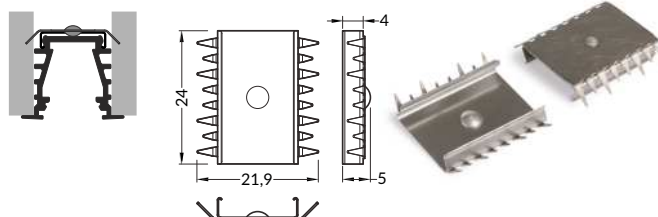

rack U flexible mounting plate

● inox
 76610019

X mounting plate
 colour: raw aluminium
 material: aluminium

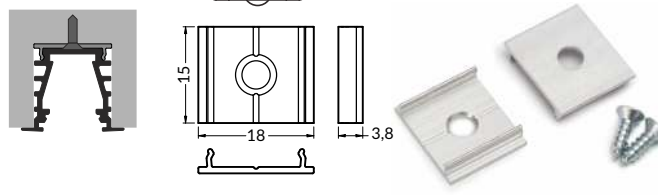

X mounting plate

● raw aluminium
 76260000

spring X mounting plate
 colour: raw aluminium
 material: aluminium

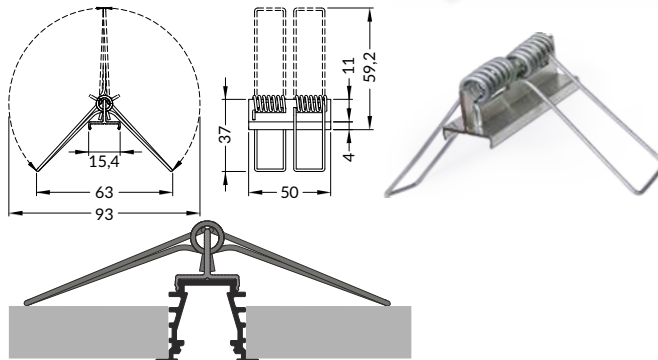

INDEX = 1 pc

spring X mounting plate

● raw aluminium
 23130000



GROOVE10 BC/UX

RECESSED ALUMINIUM PROFILE

- used mainly in furniture
- ceiling installation possible
- 6 types of covers
- maximum LED strip width: 10 mm

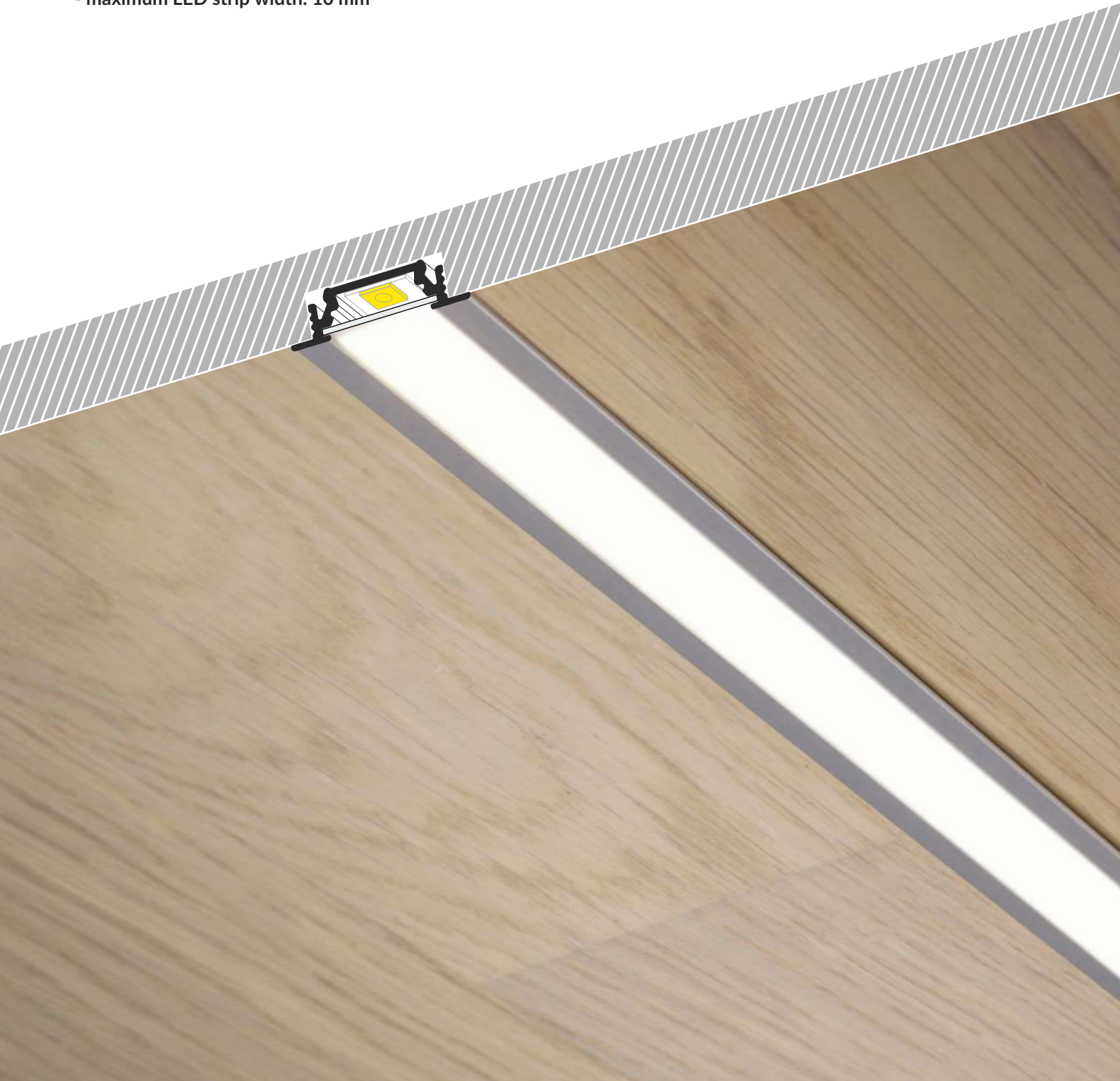

SIMILAR IN THE OFFER



DEEP10
BC/UX



TRIO10
BC



BEGTIN12
J/S



UNI12
BCD/U



GROOVE14
EF/TY



B slide cover
B

C click cover
C

C lens cover
C

U¹ U flexible mounting plate

U² cone U flexible mounting plate

U³ rack U flexible mounting plate

X¹ X mounting plate

X² spring X mounting plate

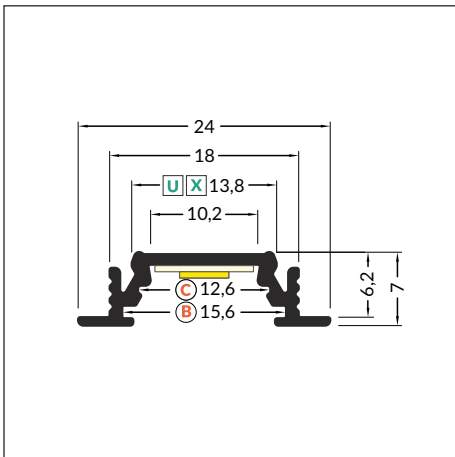
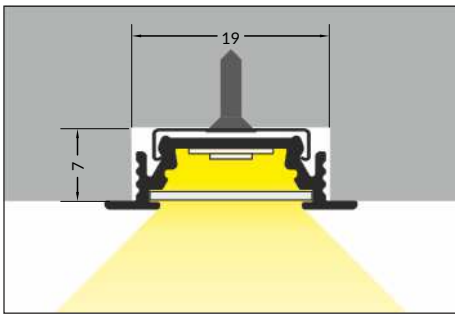
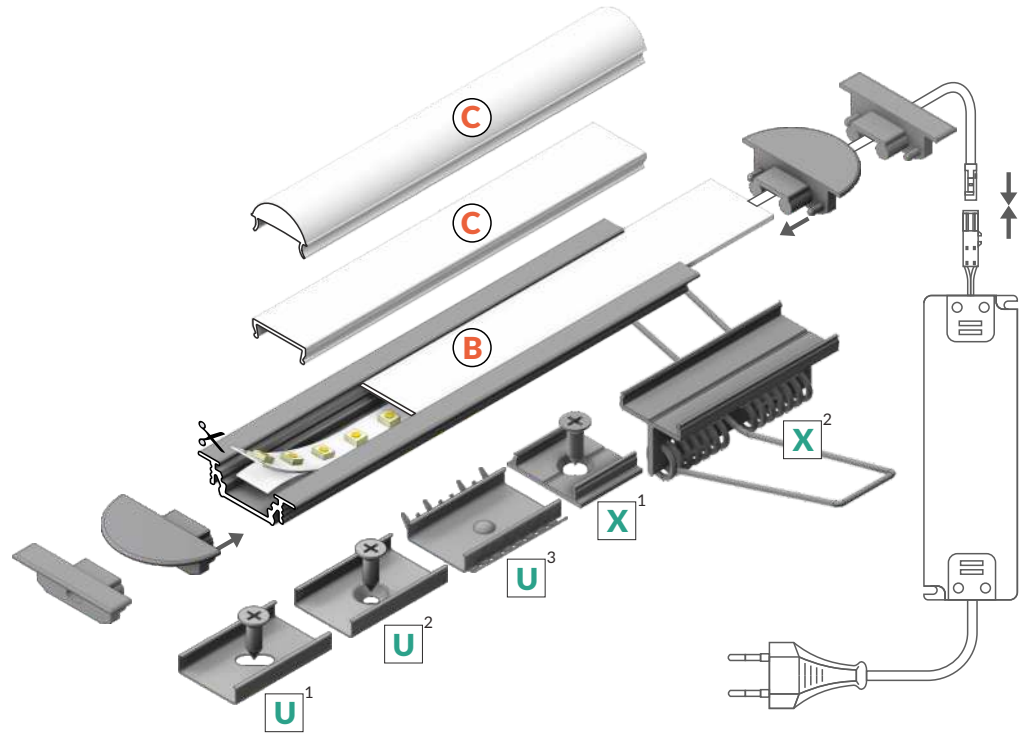

INDEX = 1 pc, length 2000 mm
package = 10 pcs

○ white painted
76210001

● anodized
76210020

● black anodized
76210021

● raw aluminium
76210000

Available lengths: 1000 mm, 2000 mm, 3000 mm, 4000 mm.
The standard profile length tolerance is +2 mm.
For more details please see page 1.08.

max 10 mm

recessed

ACCESSORIES



COVERS

B slide cover
 colours: transparent, frosted, opal
 material: PC, PP, PP

C click cover
 colours: transparent, opal
 material: PMMA

C click cover lens
 colour: transparent
 material: PC



Note! Dimensions of the space needed to install LED source

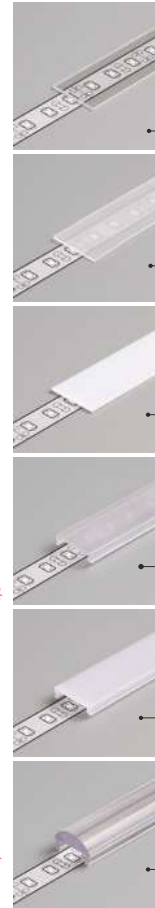
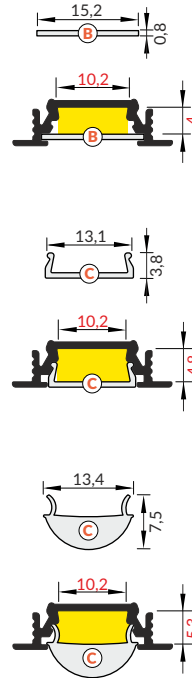

INDEX = 1 pc, length 2000 mm
 package = 10 pcs

B transparent
 76250016

B frosted
 76250039

B opal
 76250038

C transparent
 76330000

C opal
 76330038

C lens
 76300000

The standard cover length tolerance is +20 mm.
 For more details please see page 1.08.

MOUNTINGS

U flexible mounting plate
 colours: inox
 material: stainless steel

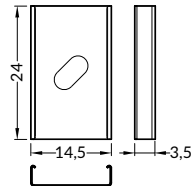
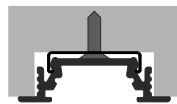

cone **U** flexible mounting plate
 colours: inox
 material: stainless steel

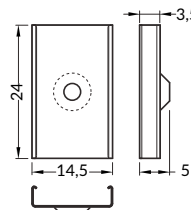
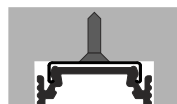

rack **U** flexible mounting plate
 colours: inox
 material: stainless steel

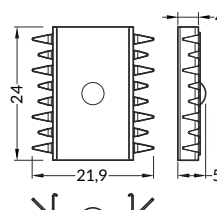

X mounting plate
 colours: raw aluminium
 material: aluminium

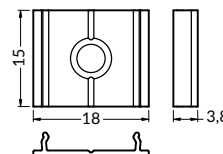
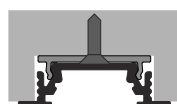

INDEX = 1 set
 package = 10 sets = 20 pcs

U flexible mounting plate

inox 76380000

cone **U** flexible mounting plate

inox 76620000

rack **U** flexible mounting plate

inox 76610019

X mounting plate

raw aluminium
 76260000

ACCESSORIES



spring X mounting plate
colours: raw aluminium
material: aluminium

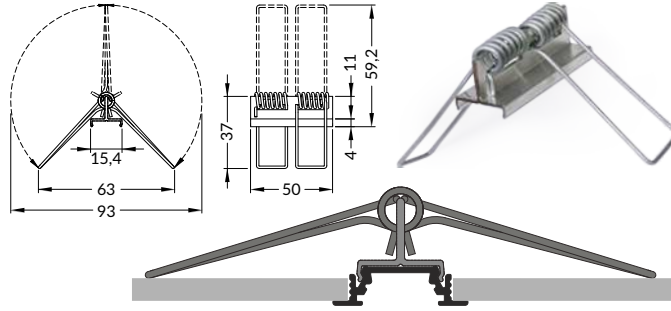

INDEX = 1 pc

spring X mounting plate



 raw aluminium
23130000

ENDINGS

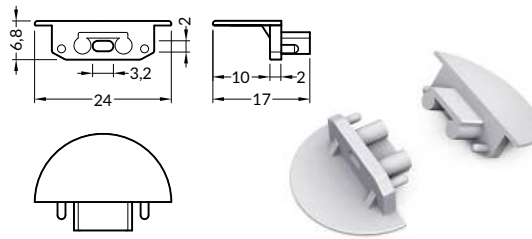
GROOVE10 ending gen2 with hole
colours: white, silver, black, grey
material: ABS





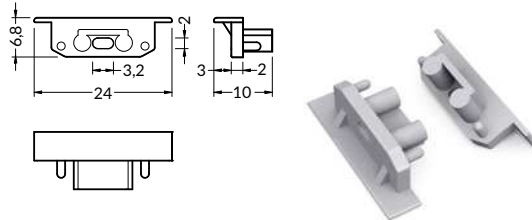

INDEX = 1 set
package = 10 sets = 20 pcs

 white 76980001
 silver 76980040
 black 76980002
 grey 76980022

GROOVE10 ending gen2 SQ with hole
colours: white, silver, black, grey
material: ABS



 white 76990001
 silver 76990040
 black 76990002
 grey 76990022

CONNECTORS

X connector 180 deg
colour: raw aluminium
material: aluminium

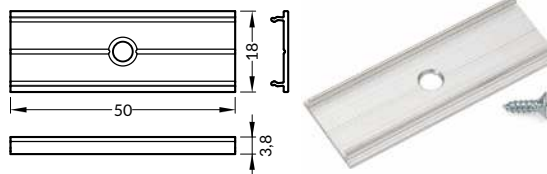

INDEX = 1 set



X connector

 raw aluminium
76350000

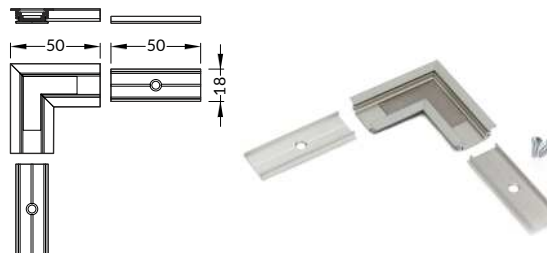
GROOVE10 connector 90 deg
colours: white, anodized, black
material: aluminium



L connector

 white painted
76530001
 anodized
76530020
 black anodized
76530021



CONTINUOUS LIGHT LINE IN SMALL RECESSED PROFILE

- suitable for use in plasterboards - does not affect the structure of the board
- used also in furniture
- continuous line of light (when using LED strip 120 p/m and opal cover)
- SLICK socket
- miniature dimensions
- maximum width of LED strip: 10 mm



SIMILAR IN THE OFFER



DEEP10
BC/UX



SMART10
A/Z



GROOVE10
BC/UX



BEGTIN12
J/S



UNI12
BCD/U



GROOVE14
EF/TY



- A slide cover
- Z¹ Z flexible mounting plate
- Z² cone Z flexible mounting plate

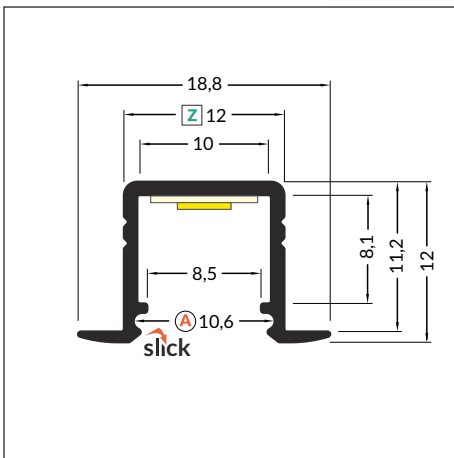
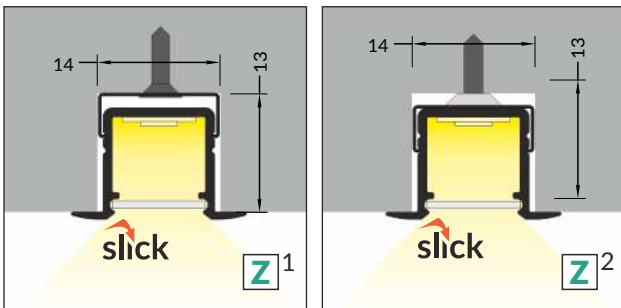
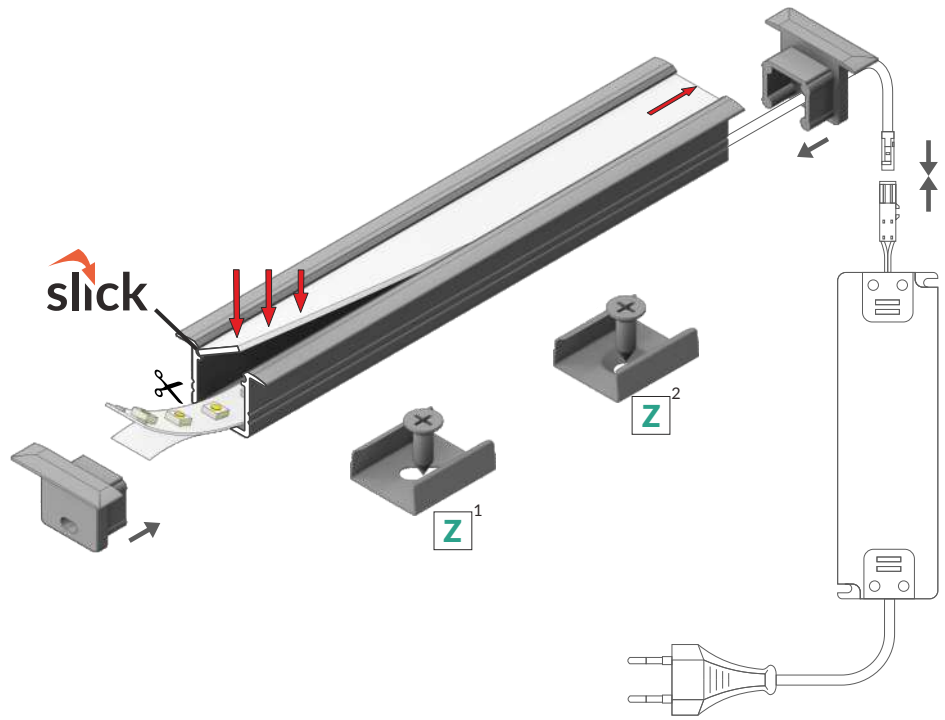

INDEX = 1 pc, length 2000 mm
package = 10 pcs

- white painted
E3020001
- anodized
E3020020
- black anodized
E3020021
- raw aluminium
E3020000

max 10 mm

recessed

Available lengths: 1000 mm, 2000 mm, 3000 mm, 4000 mm.
The standard profile length tolerance is +2 mm.
For more details please see page 1.08.



COVERS

A slide cover
 colours: transparent, frosted, opal
 material: PC, PP, PP



Note! Dimensions of the space to install LED source

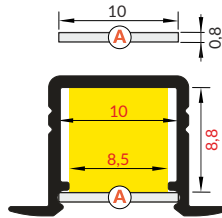

INDEX = 1 pc, length 2000 mm
 package = 10 pcs

A transparent
 89070016

A frosted
 89070039

A opal
 89070038



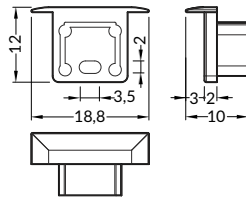

The standard cover length tolerance is +20 mm.
 For more details please see page 1.08.

ENDINGS

SMART-IN10 ending with hole
 colours: white, silver, black, grey
 material: ABS



INDEX = 1 set
 package = 10 sets = 20 pcs

-  white E3990001
-  silver E3990040
-  black E3990002
-  grey E3990022

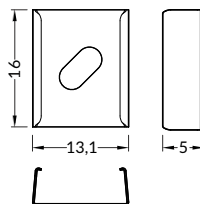
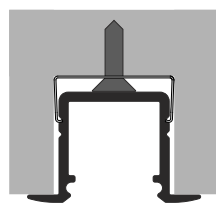

MOUNTINGS

Z flexible mounting plate
 colours: white, inox, black
 material: stainless steel



INDEX = 1 set
 package = 10 sets = 20 pcs



Z flexible mounting plate

-  white 89270001
-  inox 89270019
-  black 89270002

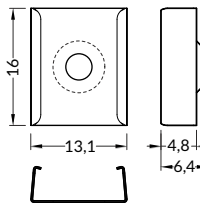
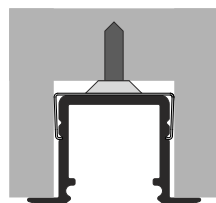
cone Z flexible mounting plate
 colours: white, inox, black
 material: stainless steel



cone Z flexible mounting plate

-  white 89980001
-  inox 89980019
-  black 89980002



BEGTIN12 J/S



SMALL RECESSED ALUMINIUM PROFILE

- light weight, budget profile
- used mainly in furniture
- Slick socket
- maximum LED strip width: 12 mm



SIMILAR IN THE OFFER



DEEP10
BC/UX



GROOVE10
BC/UX



SMART-IN10
A/Z



BEGTIN12
J/S



- J** slide cover
- S¹** flexible mounting plate
- S²** cone S flexible mounting plate

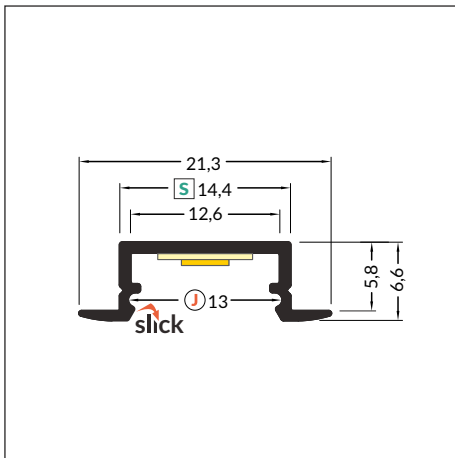
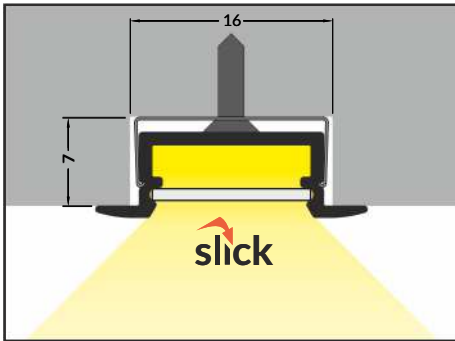
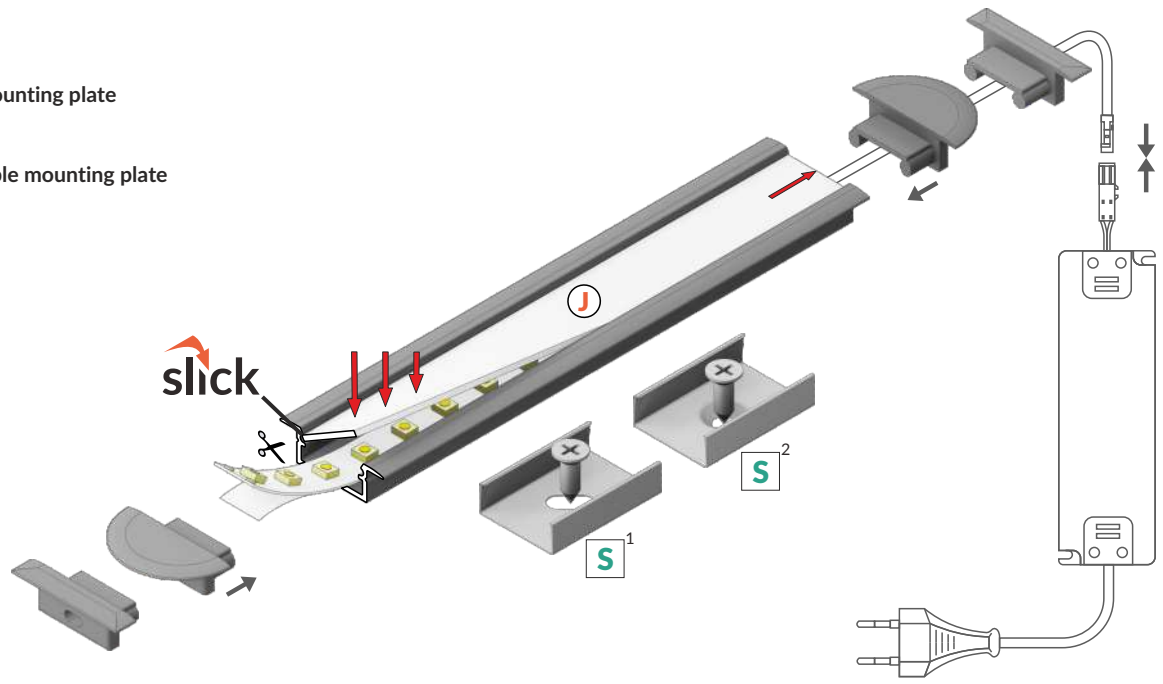

 max 12 mm

 recessed



INDEX = 1 pc, length 2000 mm
package = 10 pcs

-  white painted
C8020001
-  anodized
C8020020
-  black anodized
C8020021
-  raw aluminium
C8020000

Available lengths: 1000 mm, 2000 mm, 3000 mm, 4000 mm.
The standard profile length tolerance is +2 mm.
For more details please see page 1.08.

ACCESSORIES



COVERS

J slide cover
 colours: transparent, frosted, opal
 material: PC, PP, PP



Note! Dimensions of the space to install LED source

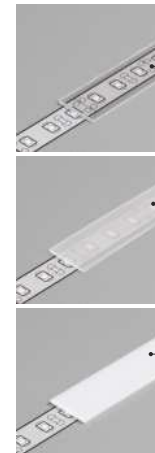
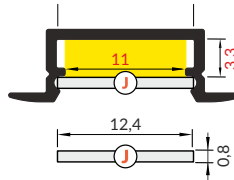

INDEX = 1 pc, length 2000 mm
 package = 10 pcs

J transparent
 70330016

J frosted
 70330039

J opal
 70330038

The standard cover length tolerance is +20 mm.
 For more details please see page 1.08.

ENDINGS

BEGTIN12 ending gen2 with hole
 colours: white, silver, black, grey
 material: ABS

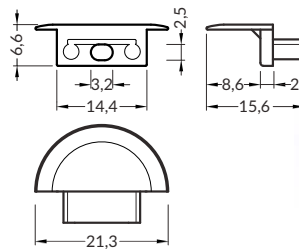

BEGTIN12 ending gen2 SQ with hole
 colours: white, silver, black, grey
 material: ABS

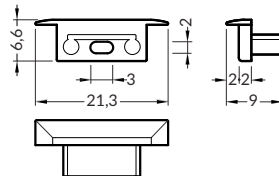

INDEX = 1 set
 package = 10 sets = 20 pcs

○ white C8980001

● silver C8980040

● black C8980002

● grey C8980022

○ white C8970001

● silver C8970040

● black C8970002

● grey C8970022

MOUNTINGS

S flexible mounting plate
 colours: white, inox, black
 material: stainless steel

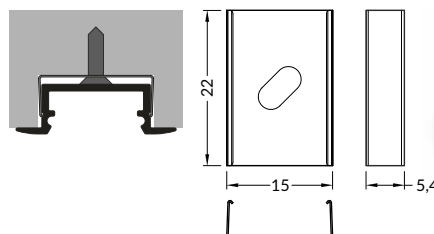

INDEX = 1 set
 package = 10 sets = 20 pcs

○ white C7980001

● inox C7980019

● black C7980002

cone S flexible mounting plate
 colours: white, inox, black
 material: stainless steel

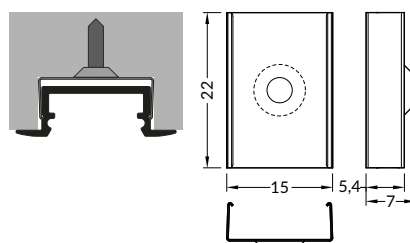

○ white C7950001

● inox C7950019

● black C7950002



FLOOR12 K/U

RECESSED FLOOR PROFILE

- high abrasion resistance, resistant cover
- possibility of waterproof
- with high humidity, please use waterproof tape
- maximum LED strip width: 12 mm



SIMILAR IN THE OFFER



STEP10
C



OUTSTAIRS12
BC



DEEP10
BC/UX



UNI12
BCD/U



K click cover

U¹ flexible mounting plate

U² cone U flexible mounting plate

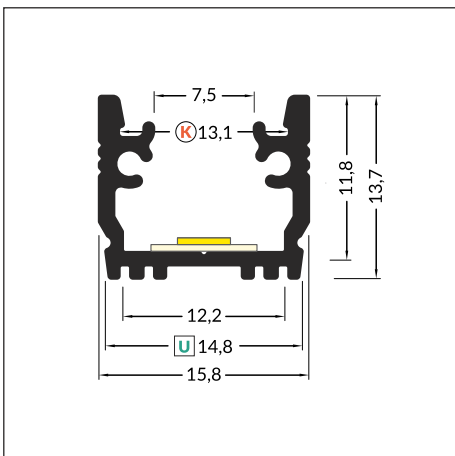
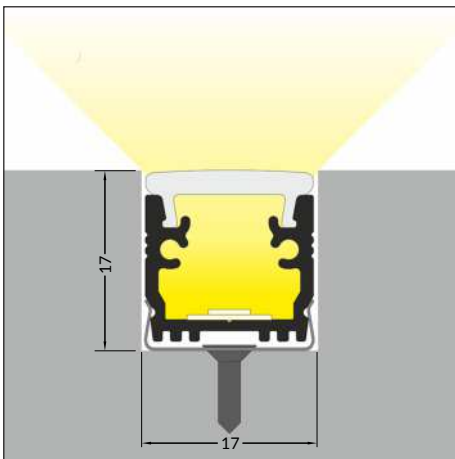
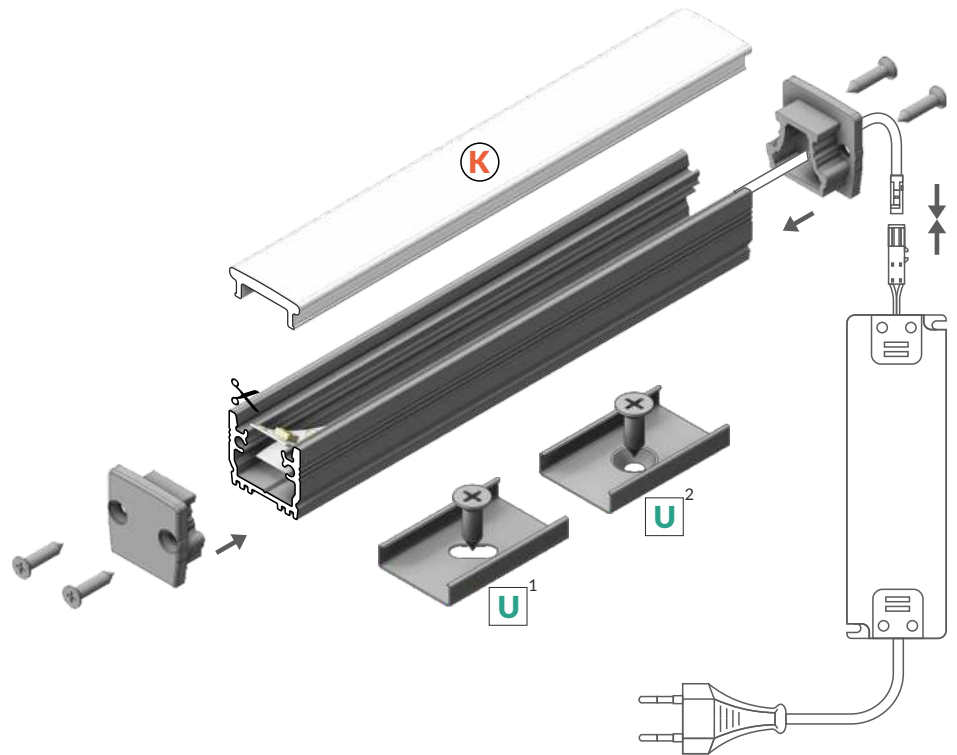

INDEX = 1 pc, length 2000 mm
package = 10 pcs

anodized
B1020020



Available lengths: 1000 mm, 2000 mm, 3000 mm, 4000 mm.
The standard profile length tolerance is +2 mm.
For more details please see page 1.08.

max 12 mm

recessed

IK08 (5 J)



↓ 5 J

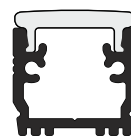

ACCESSORIES



COVERS

K click cover
 colour: opal
 material: PC

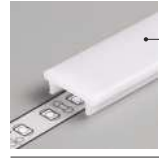
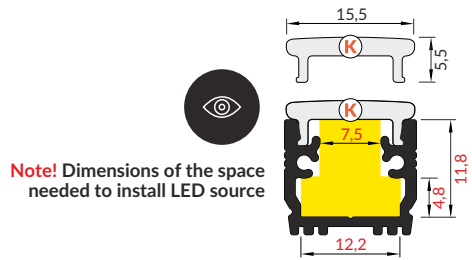

INDEX = 1 pc, length 2000 mm
 package = 10 pcs

K opal
B1040038

The standard cover length tolerance is +20 mm.
 For more details please see page 1.08.

ENDINGS

FLOOR12 ending
 colours: silver, grey
 material: ABS

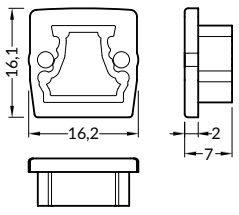

FLOOR12 ending with hole
 colours: silver, grey
 material: ABS

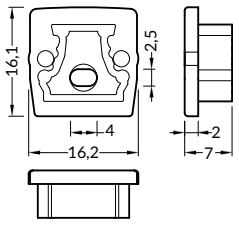

INDEX = 1 set
 package = 10 sets = 20 pcs

- silver
 - with hole | without hole
 - B1960040** | **B1940040**
- grey
 - with hole | without hole
 - B1960022** | **B1940022**

MOUNTINGS

U flexible mounting plate
 colour: inox
 material: stainless steel

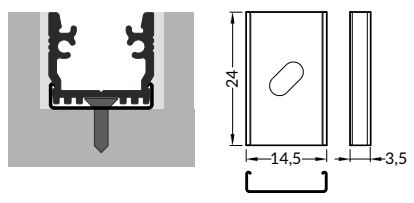

cone **U** flexible mounting plate
 colour: inox
 material: stainless steel

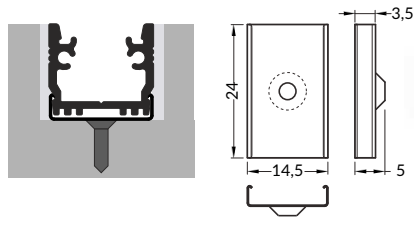

INDEX = 1 set
 package = 10 sets = 20 pcs

U flexible mounting plate

● inox
76380000

cone **U** flexible mounting plate

● inox
76620000

SEALING

sealings for **FLOOR12** endings
 2x silicone sealings
 4x rubber o-ring

 In high humidity conditions use waterproof tape and silicone seal



INDEX = 1 set

sealing set
B1830000



GROOVE14 EF/TY

BASIC ALUMINIUM RECESSED PROFILE

- used mainly in furniture
- maximum LED strip width: 14 mm

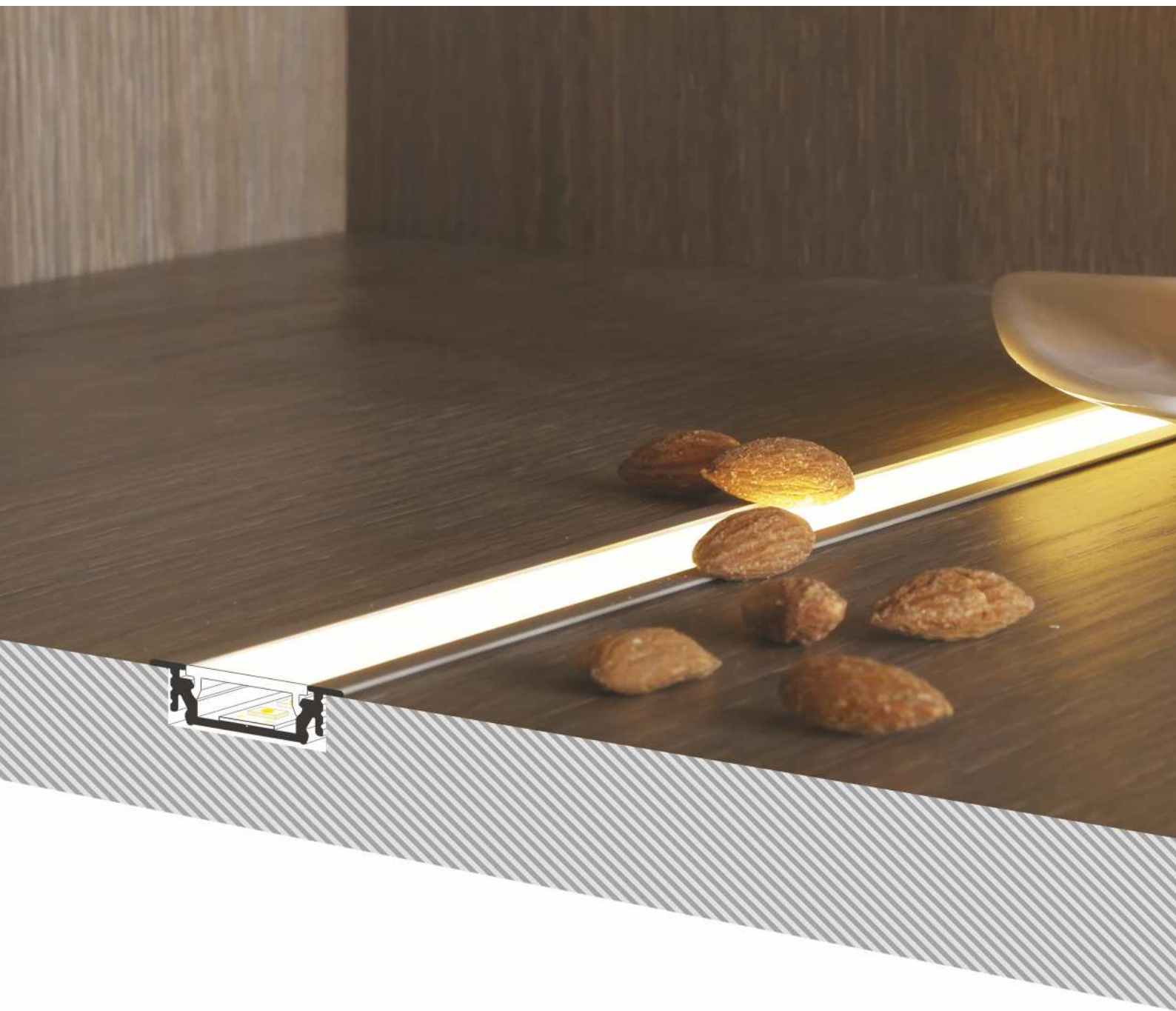

SIMILAR IN THE OFFER



DEEP10
BC/UX



GROOVE10
BC/UX



TRIO10
BC



UNI12
BCD/U



- E** slide cover
- F** click cover
- E7** E7 click cover
- Y**¹ Y flexible mounting plate
- Y**² cone Y flexible mounting plate cone
- T** T mounting plate

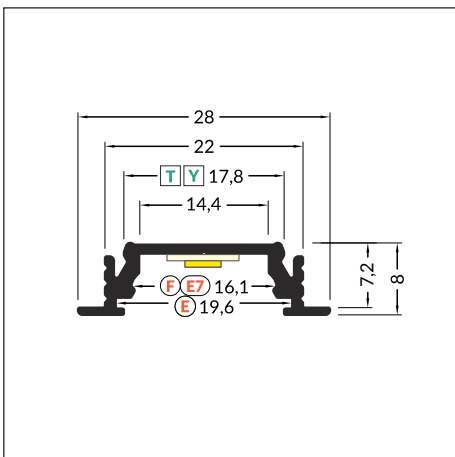
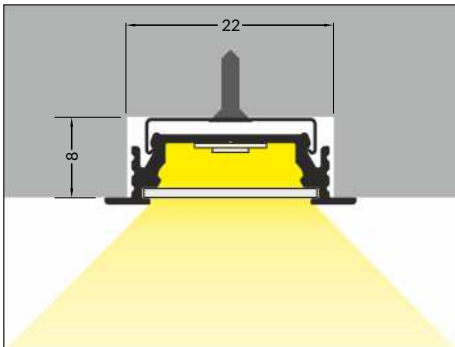
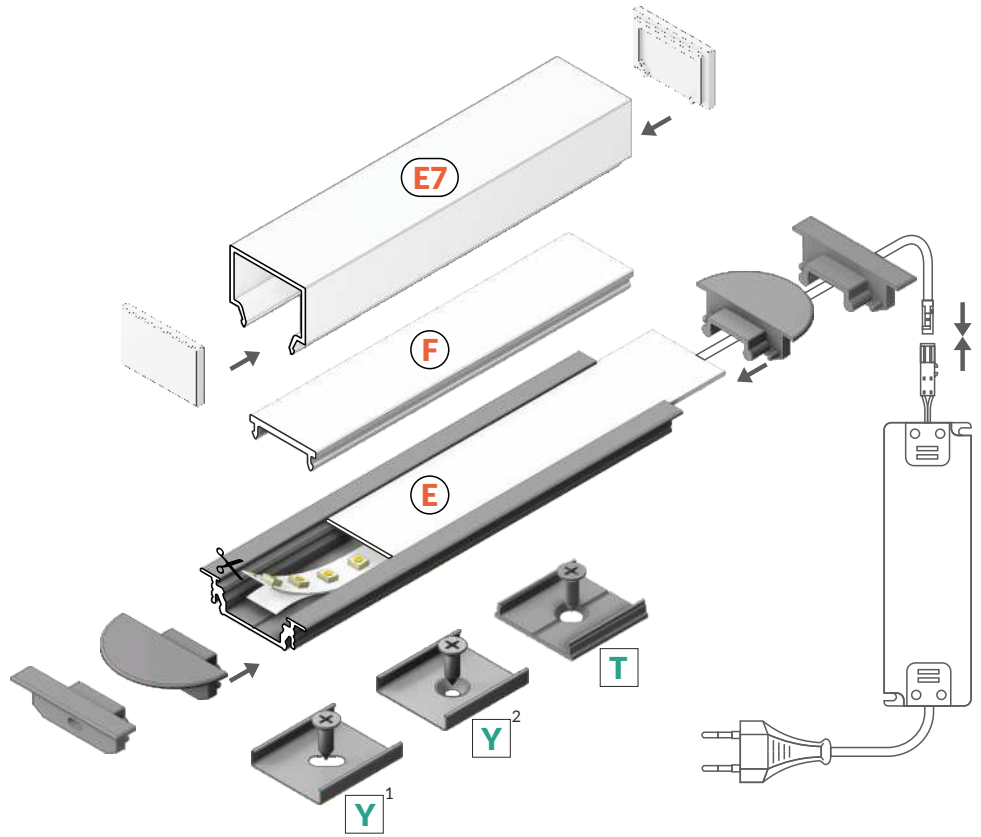

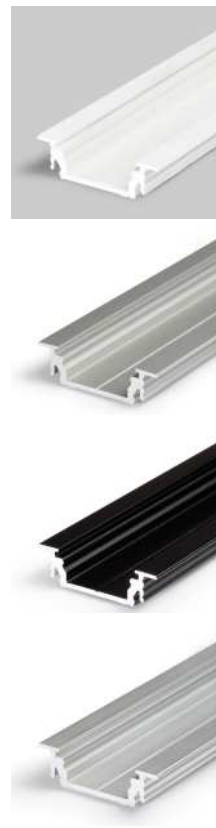

 max 14 mm

 recessed



INDEX = 1 pc, length 2000 mm
package = 10 pcs

 white painted
A3020001

 anodized
A3020020

 black anodized
A3020021

 raw aluminium
A3020000

Available lengths: 1000 mm, 2000 mm, 3000 mm, 4000 mm.
The standard profile length tolerance is +2 mm.
For more details please see page 1.08.

ACCESSORIES



COVERS

E slide cover
 colours: transparent, frosted, opal
 material: PC, PP, PP



Note! Dimensions of the space to install LED source

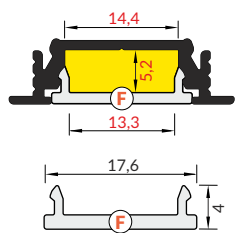
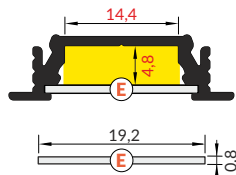

F click cover
 colours: transparent, opal
 material: PMMA

E7 click cover
 colour: opal
 material: PMMA

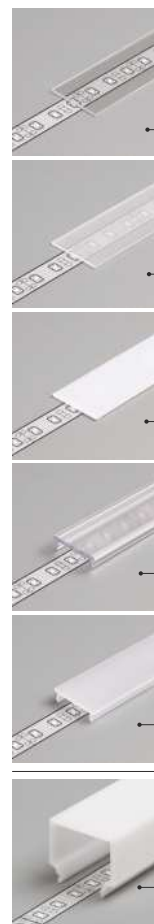
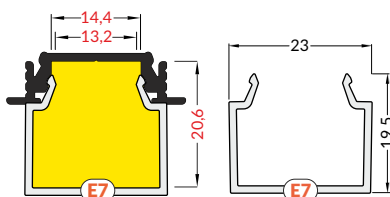

INDEX = 1 pc, length 2000 mm
 package = 10 pcs

E transparent
 A2040016

E frosted
 A2040039

E opal
 A2040038

F transparent
 A2060016

F opal
 A2060038

E7 opal
 C1080038

The standard cover length tolerance is +20 mm.
 For more details please see page 1.08.

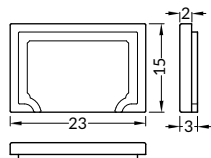

INDEX = 1 set
 package = 10 sets = 20 pcs

E7 opal ending

C1840038

MOUNTINGS

Y flexible mounting plate
 colour: inox
 material: stainless steel

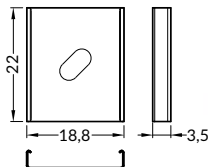
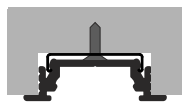

INDEX = 1 set
 package = 10 sets = 20 pcs

Y flexible mounting plate

inox A2090019

cone **Y** flexible mounting plate
 colour: inox
 material: stainless steel

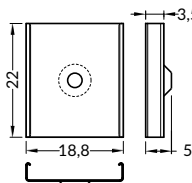

cone **Y** flexible mounting plate

inox A2130019

T mounting plate
 colour: raw aluminium
 material: aluminium

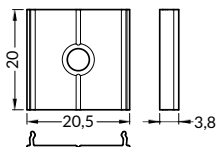
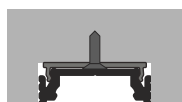

T mounting plate

raw aluminium C6960000



ENDINGS

GROOVE14 ending gen2 with hole
 colours: white, silver, black, grey
 material: ABS

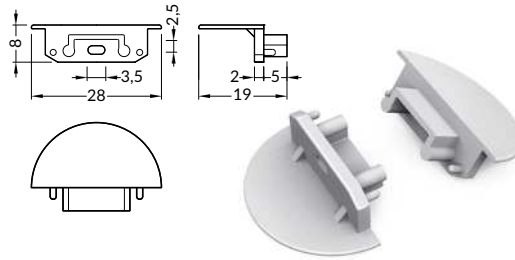

GROOVE14 ending gen2 SQ with hole
 colours: white, silver, black, grey
 material: ABS

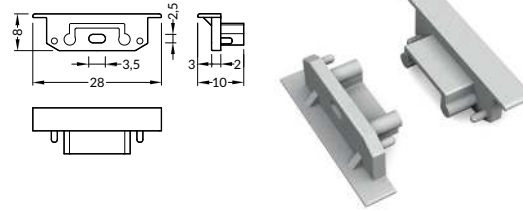

INDEX = 1 set
 package = 10 sets = 20 pcs

-  white A3970001
-  silver A3970040
-  black A3970002
-  grey A3970022
-  white A3980001
-  silver A3980040
-  black A3980002
-  grey A3980022

CONNECTORS

T connector 180 deg
 colour: raw aluminium
 material: aluminium

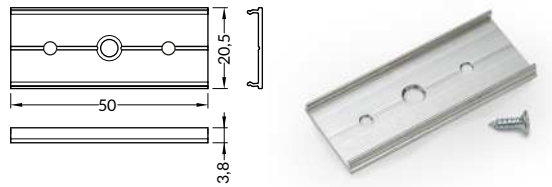

GROOVE14 connector 90 deg
 colours: white, anodized, black
 material: aluminium

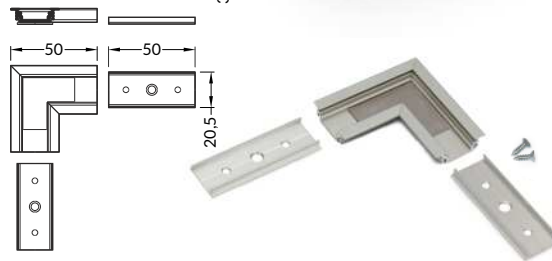



INDEX = 1 set

T connector

-  raw aluminium C6990000

connector 90 deg

-  white painted A3990001
-  anodized A3990020
-  black anodized A3990021



SMART-IN16 B/U4



ECONOMICAL RECESSED PROFILE FOR 16 mm LED STRIP

- SLICK socket - easy assembly technology
- various ways of mounting
- continuous line of light (when using LED strip 120 P/m and opal cover)
- maximum width of LED strip: 16 mm



SIMILAR IN THE OFFER



SMART16
B/U4



SMART-IN10
A/Z



BEGTIN12
J/S



GROOVE14
EF/TY



LINEA-IN20
EF/U7



- B** slide cover
- U4**¹ U4 mounting plate
- U4**² cone U4 mounting plate
- U4**³ spring U4 mounting plate

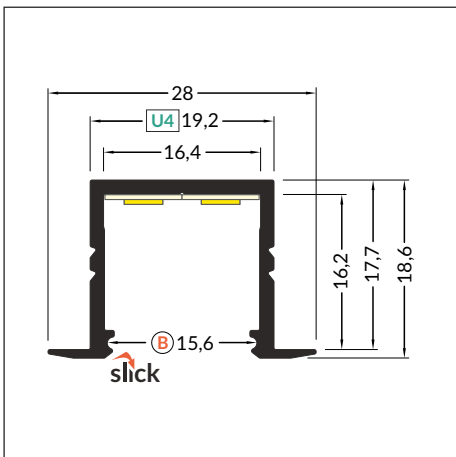
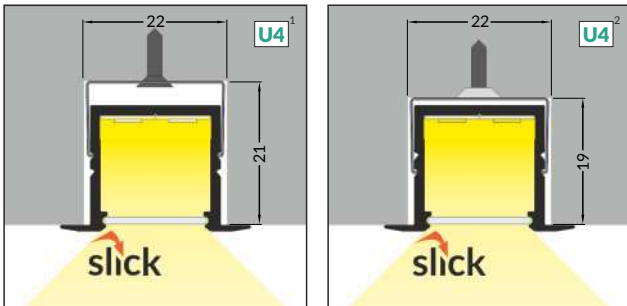
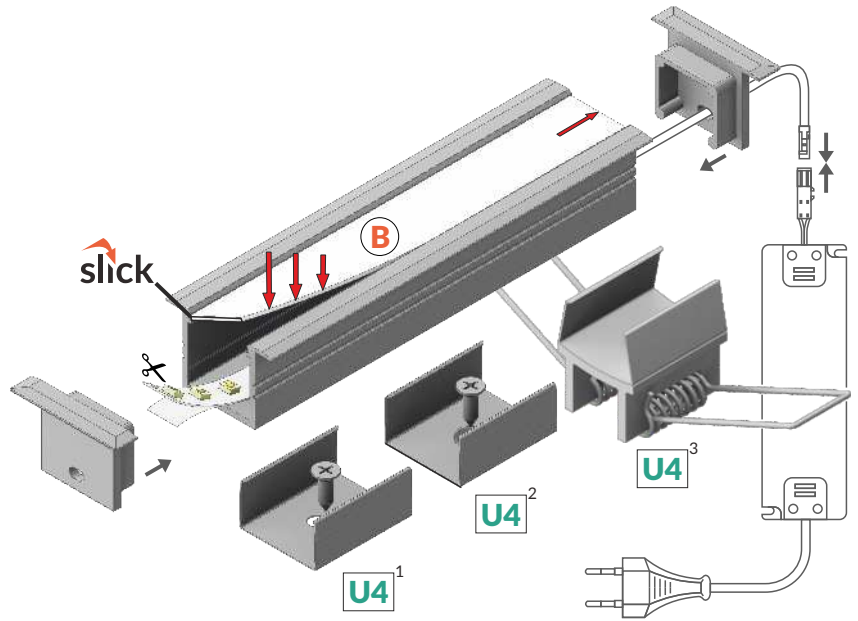

INDEX = 1 pc, length 2000 mm
package = 10 pcs



white painted
F6000201



anodized
F6000220



raw aluminium
F6000200

Available lengths: 1000 mm, 2000 mm, 3000 mm, 4000 mm.
The standard profile length tolerance is +2 mm.
For more details please see page 1.08.

ACCESSORIES



COVERS

B slide cover
 colours: transparent, frosted, opal
 material: PC, PP, PP



Note! Dimensions of the space to install LED source

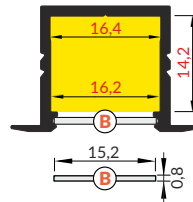

INDEX = 1 pc, length 2000 mm
 package = 10 pcs

B transparent
 76250016

B frosted
 76250039

B opal
 76250038

The standard cover length tolerance is +20 mm.
 For more details please see page 1.08.

ENDINGS

SMART-IN16 ending with hole
 colours: white, silver, black, grey
 material: ABS

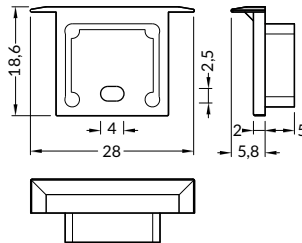

INDEX = 1 set
 package = 10 sets = 20 pcs

○ white
 F6009901

● silver
 F6009940

● grey
 F6009922

MOUNTINGS

U4 mounting plate
 colours: white, inox
 material: stainless steel

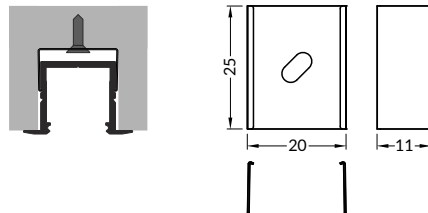

INDEX = 1 set
 package = 10 sets = 20 pcs

U4 mounting plate

○ white F1970001

● inox F1970019

cone U4 mounting plate
 colours: white, inox
 material: stainless steel

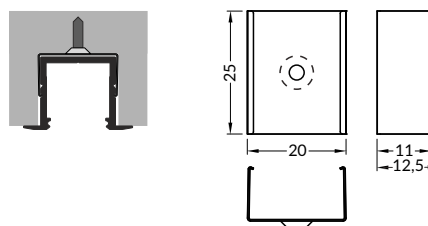

cone **U4** mounting plate

○ white F1980001

● inox F1980019

spring U4 mounting plate
 colours: inox
 material: stainless steel

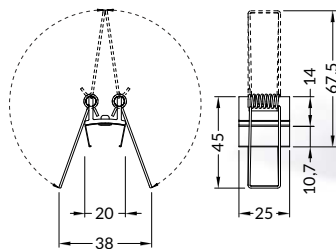

INDEX = 2 pcs

spring **U4** mounting plate

● inox F6009819S

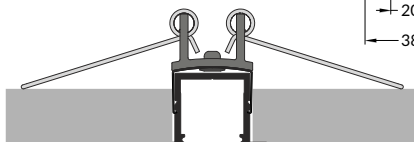



LINEA-IN20 EF/U7

CREATING LIGHTING PATTERNS THANKS TO ANGULAR CONNECTORS

- continuous line of light (when using LED strip 120 P/m and opal cover)
- angled connections illuminated
- 20 accessories available
- 3 mounting options of LED modules: thermic tape, LED module on a strip, additionally LED clamp
- maximum LED source width: 20 mm

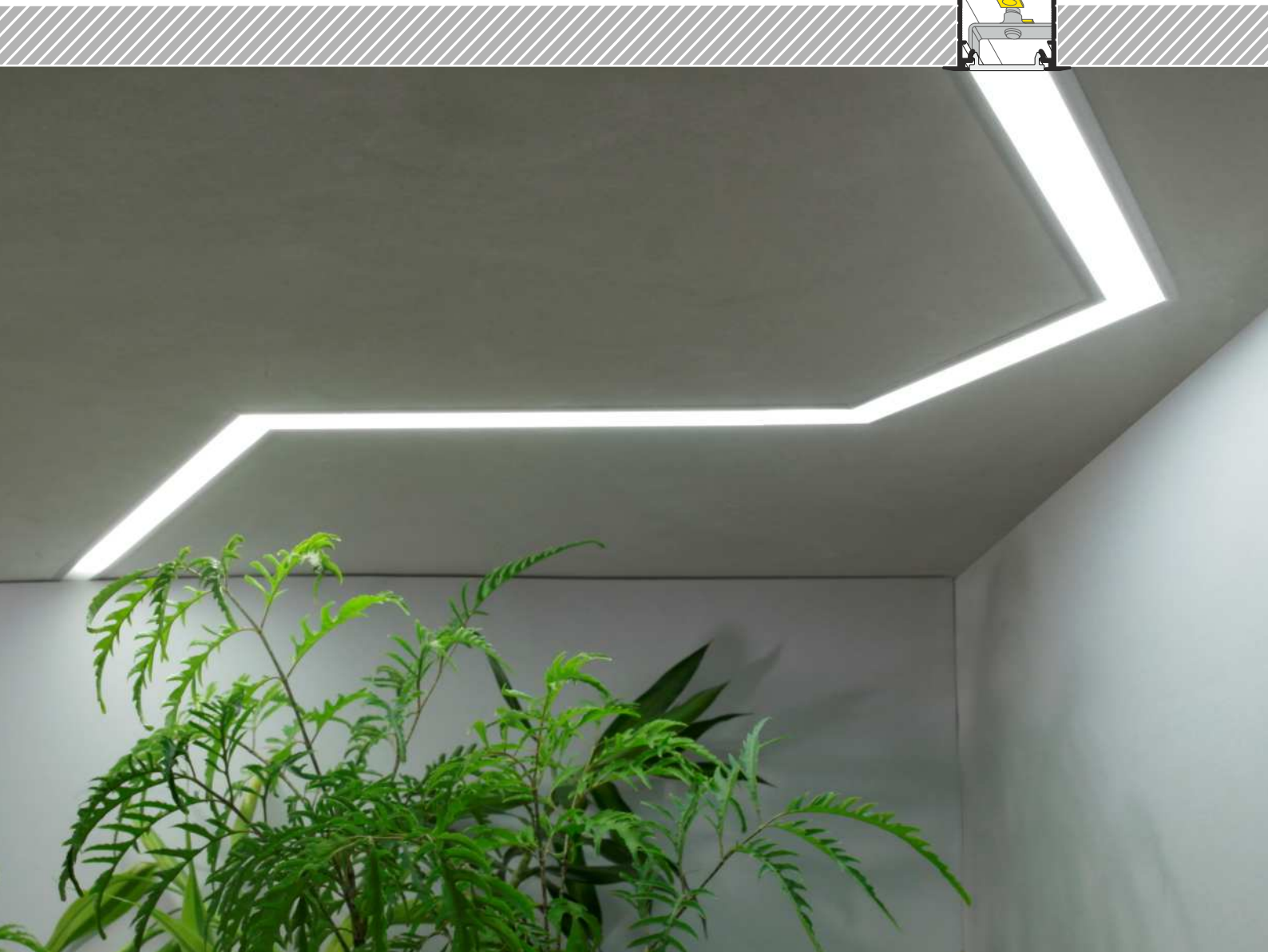
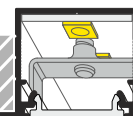

SIMILAR IN THE OFFER

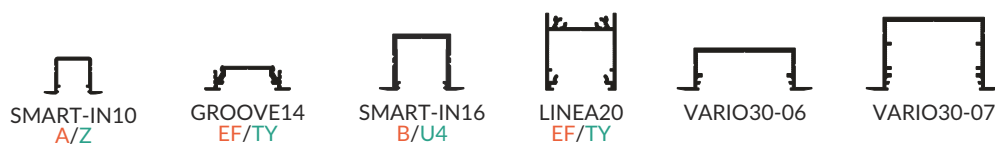





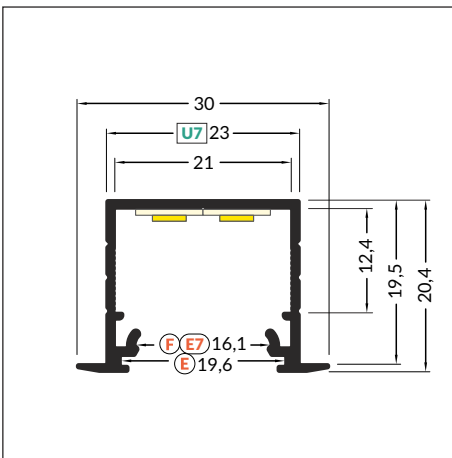
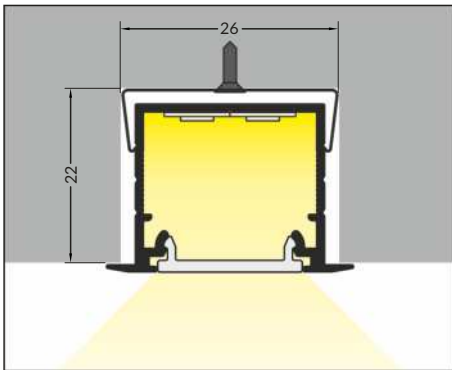
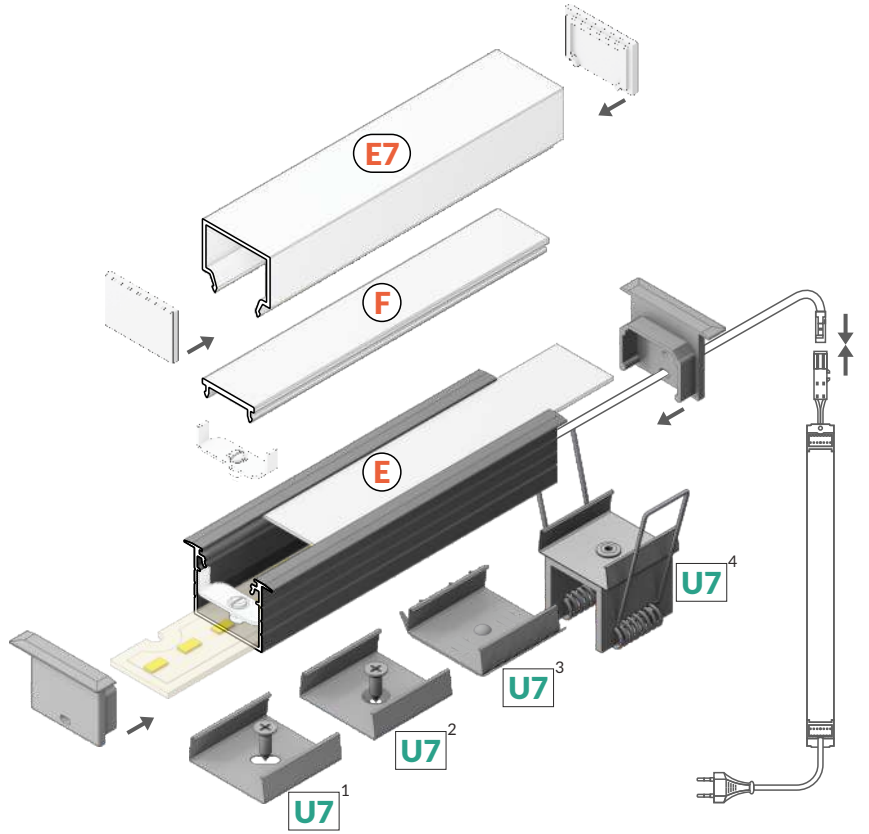

- E** slide cover
- F** click cover
- E7** click cover
- U7**¹ U7 mounting plate
- U7**² cone U7 mounting plate
- U7**³ rack U7 mounting plate
- U7**⁴ spring U7 mounting plate



INDEX = 1 pc, length 2000 mm
package = 10 pcs

-  white painted
E4020001
-  anodized
E4020020
-  black anodized
E4020021
-  raw aluminium
E4020000

Available lengths: 1000 mm, 2000 mm, 3000 mm, 4000 mm.
The standard profile length tolerance is +2 mm.
For more details please see page 1.08.

 max 20 mm

 recessed



COVERS

E slide cover
colours: transparent, frosted, opal
material: PC, PP, PP



Note! Dimensions of the space to install LED source

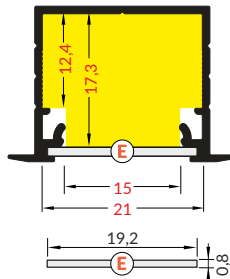

INDEX = 1 pc, length 2000 mm
package = 10 pcs

E transparent
A2040016



E frosted
A2040039

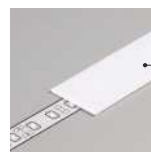

E opal
A2040038

F click cover
colours: transparent, opal
material: PMMA

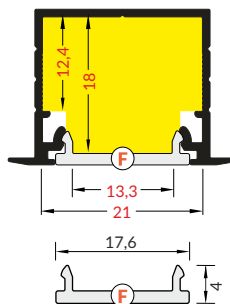

F transparent
A2060016

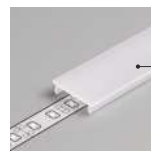

F opal
A2060038

E7 click cover
colour: opal
material: PMMA

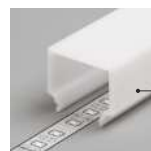
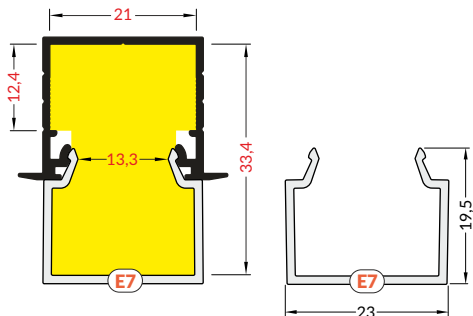

E7 opal
C1080038

The standard cover length tolerance is +20 mm.
For more details please see page 1.08.

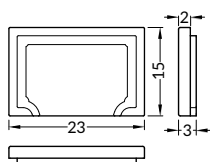

INDEX = 1 set
package = 10 sets = 20 pcs

E7 opal ending

C1840038

ENDINGS

LINEA-IN20 ending with hole
colours: white, silver, black, grey
material: ABS

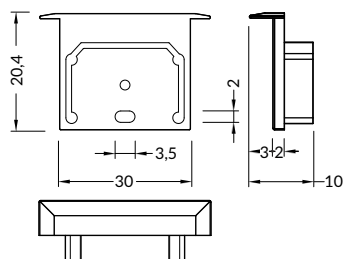

INDEX = 1 set
package = 10 sets = 20 pcs

○ white E4990001

● silver E4990040

● black E4990002

● grey E4990022



MOUNTINGS

U7 mounting plate
 colour: inox
 material: stainless steel

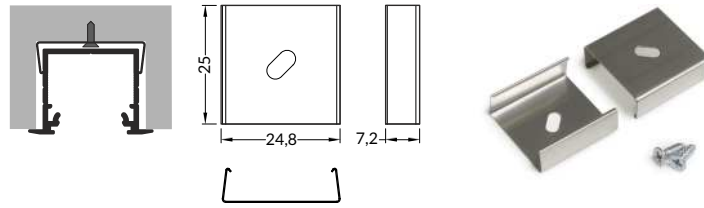

cone U7 mounting plate
 colour: inox
 material: stainless steel

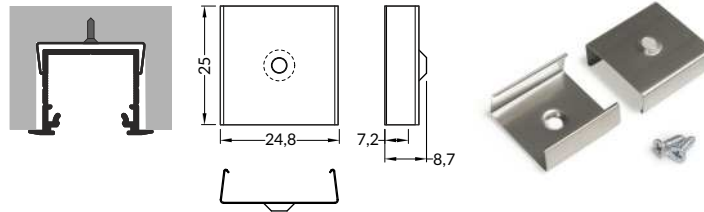

rack U7 mounting plate
 colour: inox
 material: stainless steel

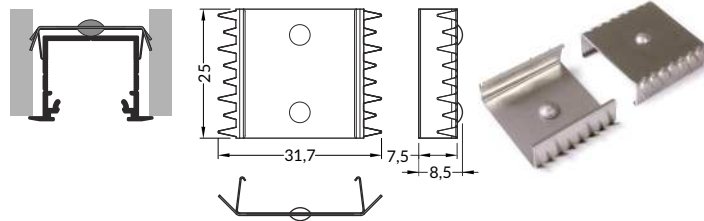

spring U7 mounting plate
 colour: inox
 material: stainless steel

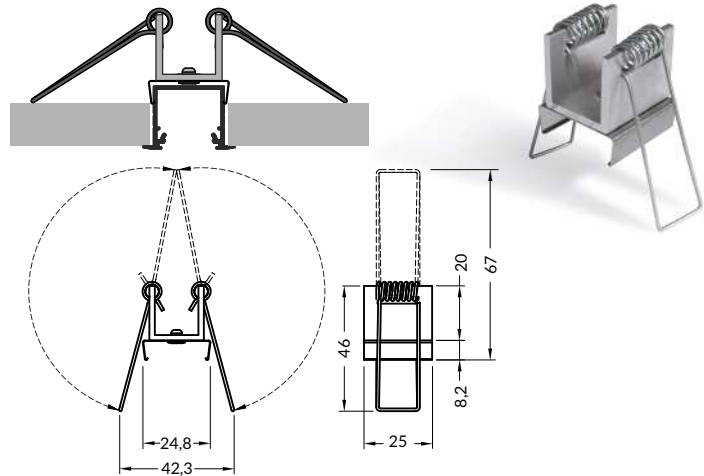

INDEX = 1 set
 package = 10 sets = 20 pcs

U7 mounting plate

inox E4960019

cone U7 mounting plate

inox E4970019

rack U7 mounting plate

inox E4980019

INDEX = 2 pcs

spring U7 mounting plate

inox E4880019s

CLAMP

LINEA20 LED clamp
 colour: white
 material: painted steel, plastic

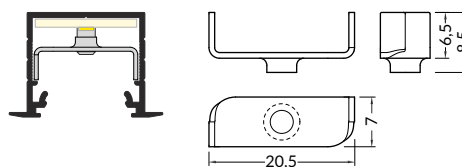

LINEA20-1 LED clamp
 colour: white
 material: painted steel, plastic

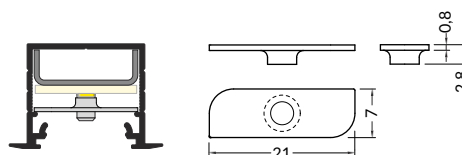

INDEX = 1 set
 package = 10 sets = 20 pcs

white C6940001

white C6930001

LINEA-IN20 EF/U7

CONNECTION POSSIBILITY



60°



90°



120°



135°



180°

ANGULAR CONNECTORS

Thanks to five different angle connectors (60° / 90° / 120° / 135° / 180°) it is possible to create many various lighting systems – with no need to cut the profile at an angle.

Bent connectors allows to connect profiles in two planes, at two angles: 90° on the inside and 270° on the outside.

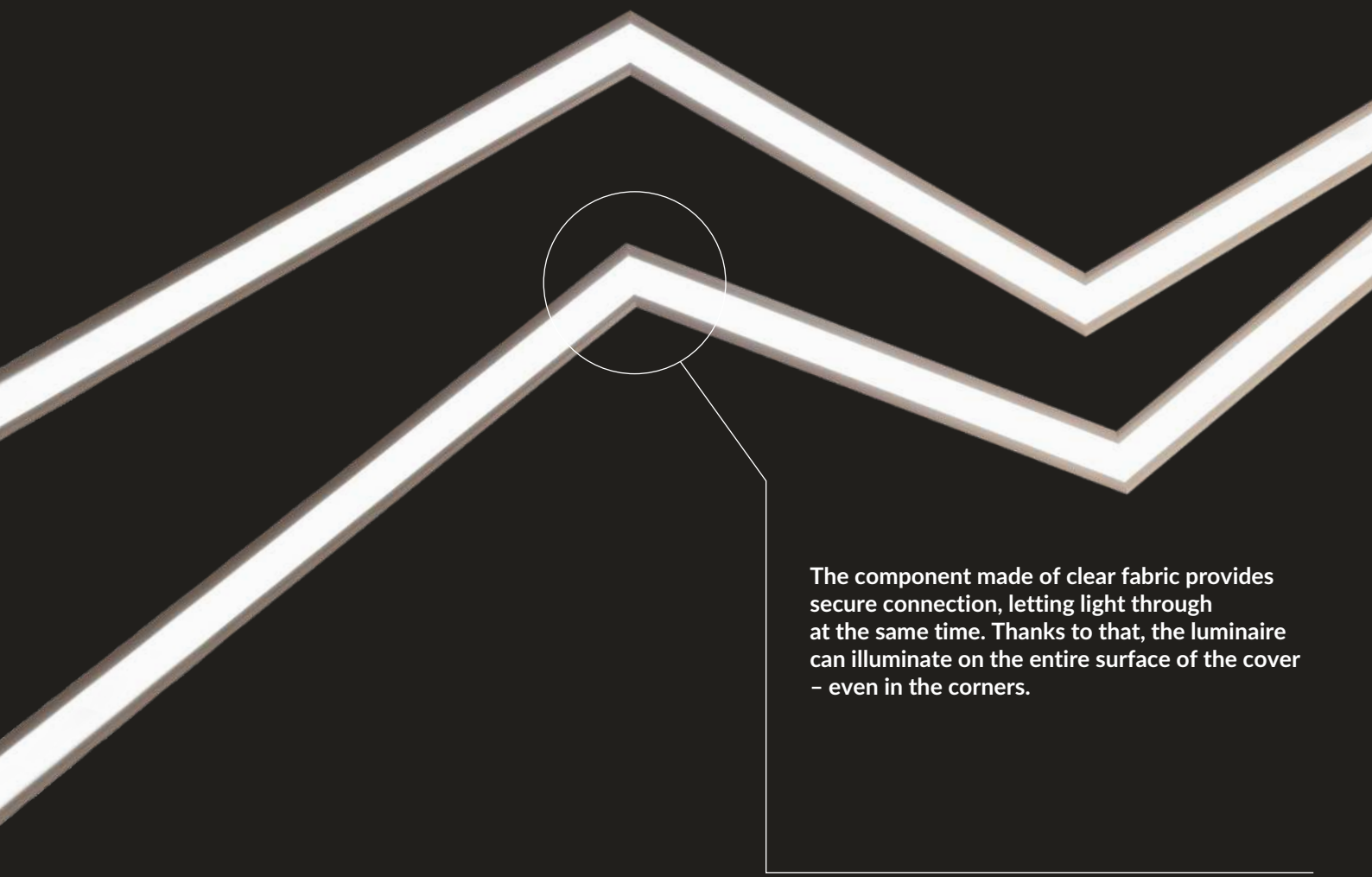

The component made of clear fabric provides secure connection, letting light through at the same time. Thanks to that, the luminaire can illuminate on the entire surface of the cover – even in the corners.



CONNECTORS

LINEA-IN20 connector 60 deg
 colours: white, anodized, black
 material: aluminium, polycarbonate

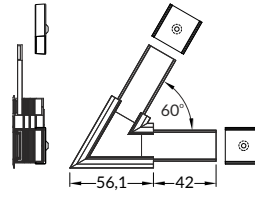

LINEA-IN20 connector 90 deg
 colours: white, anodized, black
 material: aluminium, polycarbonate

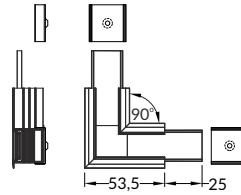

LINEA-IN20 connector 90 deg bent
 colours: white, anodized, black
 material: aluminium, polycarbonate

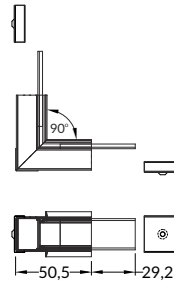

LINEA-IN20 connector 120 deg
 colours: white, anodized, black
 material: aluminium, polycarbonate

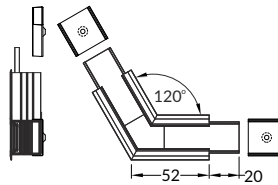

LINEA-IN20 connector 135 deg
 colours: white, anodized, black
 material: aluminium, polycarbonate

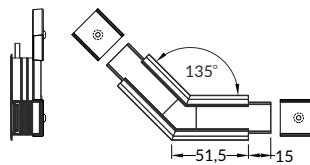

LINEA-IN20 connector 180 deg
 material: polycarbonate

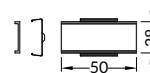

LINEA-IN20 connector 270 deg bent
 colours: white, anodized, black
 material: aluminium, polycarbonate

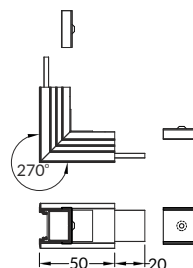

INDEX = 1 set

connector 60 deg

	white painted	E4890001s
	anodized	E48900020s
	black anodized	E48900021s

connector 90 deg

	white painted	E4900001s
	anodized	E49000020s
	black anodized	E49000021s

connector 90 deg bent

	white painted	E4910001s
	anodized	E49100020s
	black anodized	E49100021s

connector 120 deg

	white painted	E4920001s
	anodized	E49200020s
	black anodized	E49200021s

connector 135 deg

	white painted	E4930001s
	anodized	E49300020s
	black anodized	E49300021s

connector 180 deg

E4940000s

connector 270 deg bent

	white painted	E4950001s
	anodized	E49500020s
	black anodized	E49500021s

LINEA-IN20 EF/U7

CONTINUOUS LIGHT OF LINE
when using LED strip 120 P/m and opal cover





TRIO10 BC

ANGULAR PROFILE 45°

- for display cases' corners (mounted with screws)
- recessed (mounted with adhesive glue)
- suitable also for lighting up steps
- maximum LED strip width: 10 mm

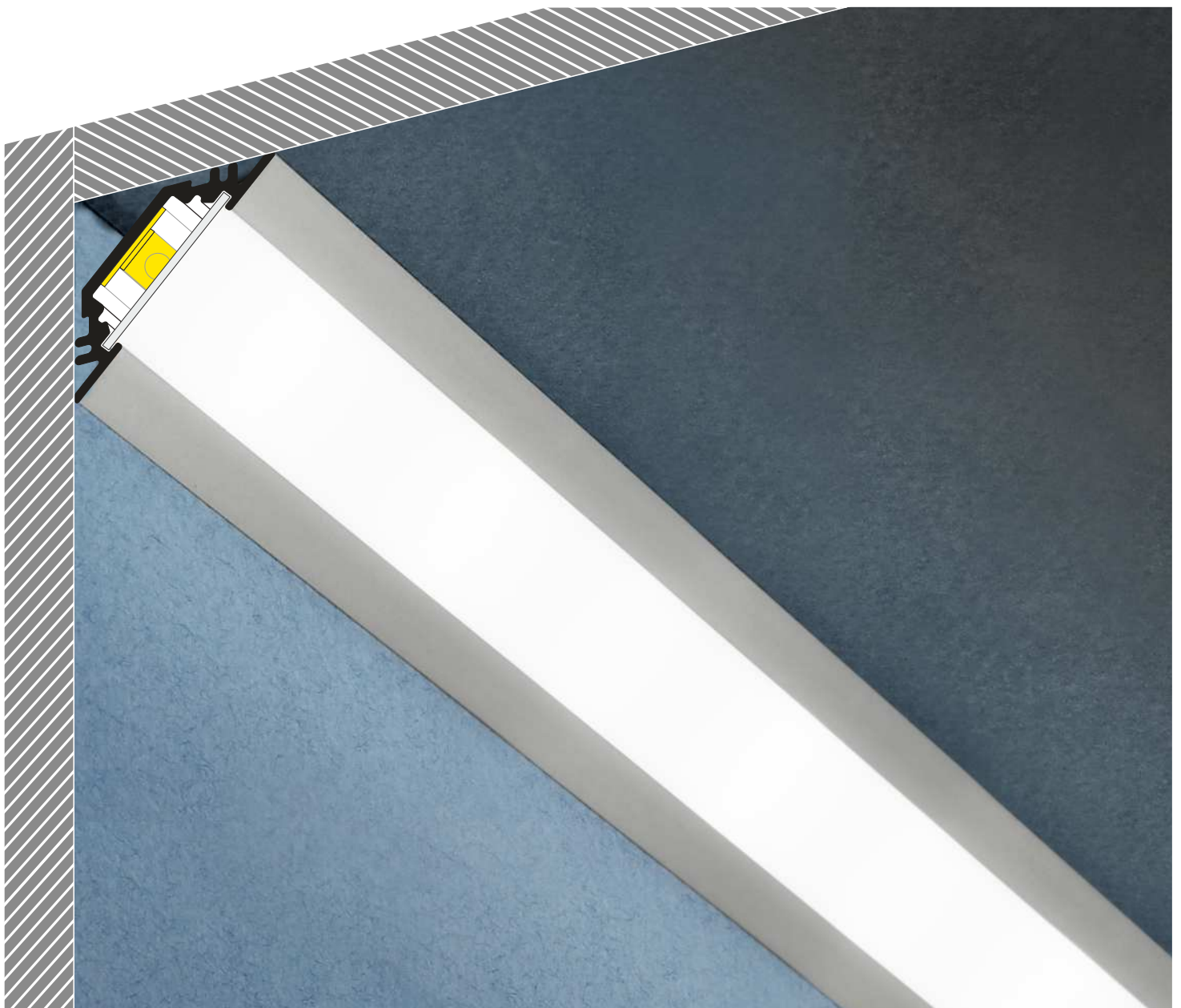

SIMILAR IN THE OFFER





B slide cover

C click cover
C

C lens cover

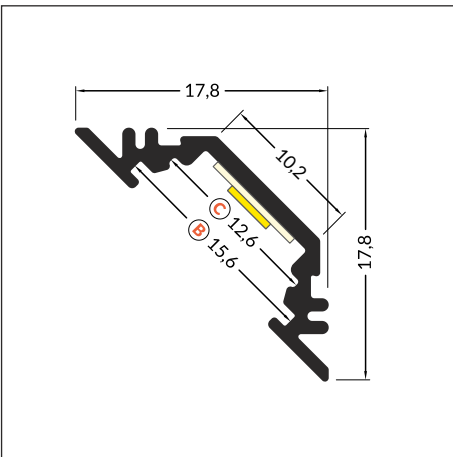
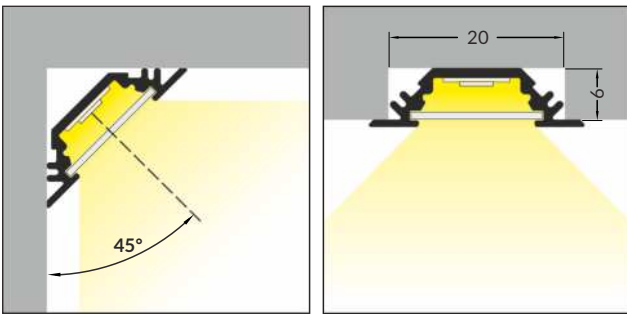
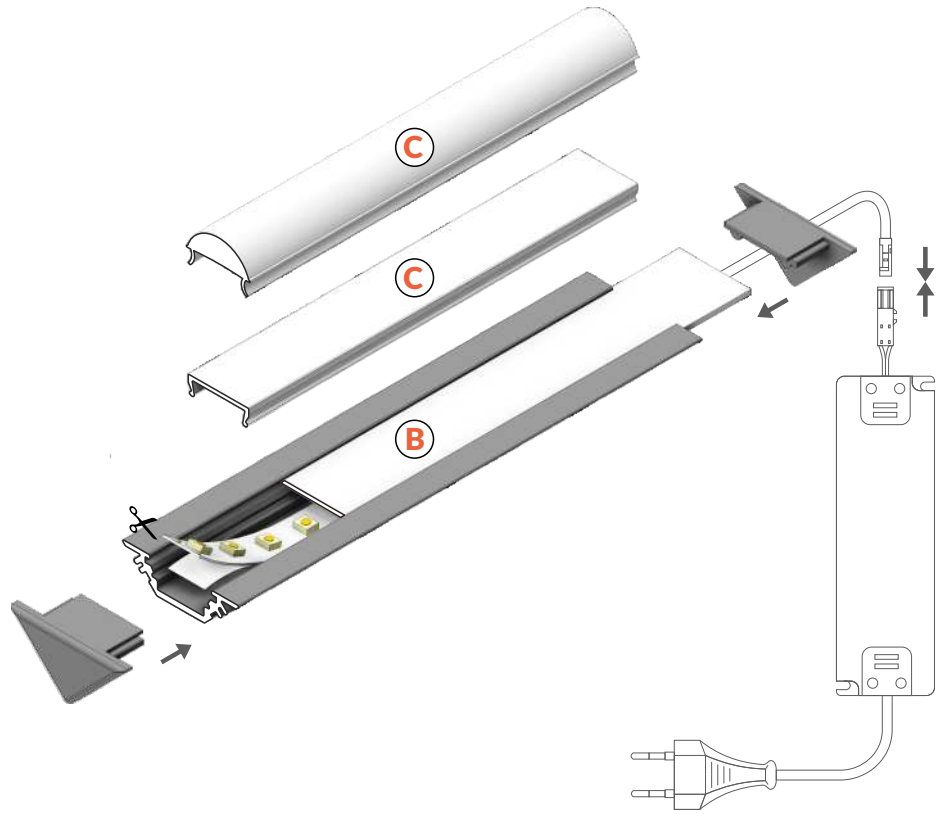

INDEX = 1 pc, length 2000 mm
package = 10 pcs

○ white painted
91030001



● anodized
91030020



● black anodized
91030021



● raw aluminium
91030000

 max 10 mm

 corner

Available lengths: 1000 mm, 2000 mm, 3000 mm, 4000 mm.
The standard profile length tolerance is +2 mm.
For more details please see page 1.08.

ACCESSORIES



COVERS

B slide cover
 colours: transparent, frosted, opal
 material: PC, PP, PP



Note! Dimensions of the space to install LED source

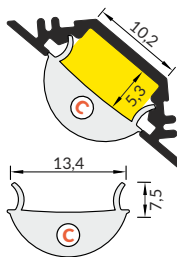
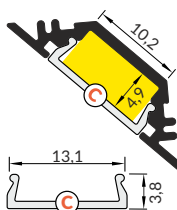
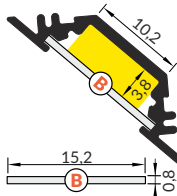

C click cover
 colours: transparent, opal
 material: PMMA

C lens click cover
 colour: transparent
 material: PC



INDEX = 1 pc, length 2000 mm
 package = 10 pcs

B transparent
 76250016

B frosted
 76250039

B opal
 76250038

C transparent
 76330000

C opal
 76330038

C lens
 76300000

The standard cover length tolerance is +20 mm.
 For more details please see page 1.08.

ENDINGS

TRIO10 ending
 colours: white, silver, black, grey
 material: ABS

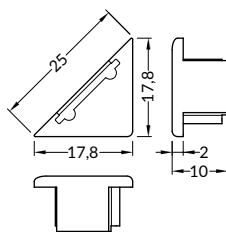

Ending with marked space to bore the holes.

INDEX = 1 set
 package = 10 sets = 20 pcs

○ white 91060001

● silver 91060040

● black 91060002

● grey 91060022

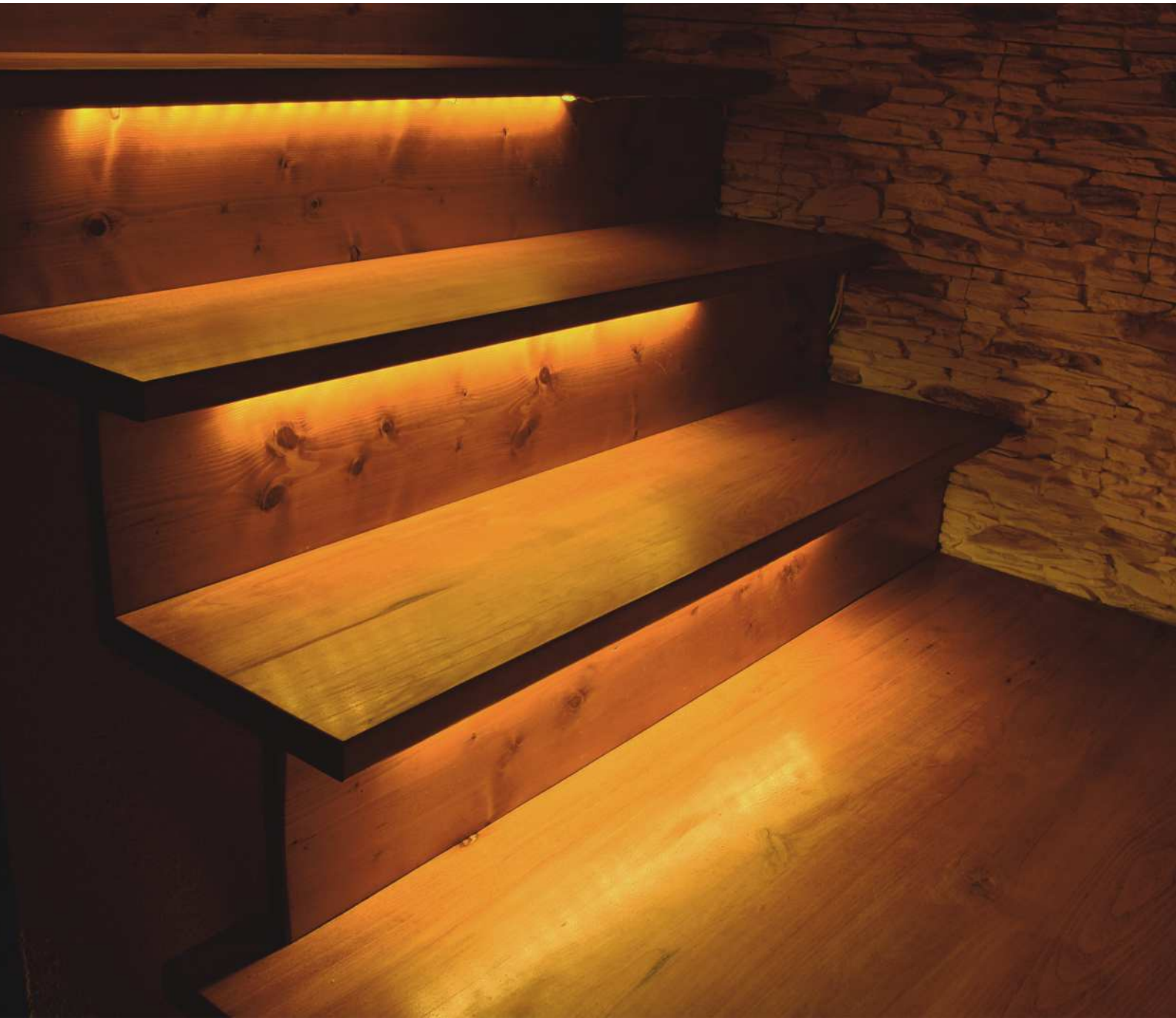

CORNER10 BC/UX

SMALL, ALUMINIUM, ANGULAR PROFILE

- lighting directions: 30° or 60°
- hidden mounting
- wide range of accessories, 6 types of covers
- maximum LED strip width: 10 mm



SIMILAR IN THE OFFER



TRIO10
BC



QUARTER10
BD/UX



CABI12
E



CORNER14
EF/TY





CORNER27
G/UX



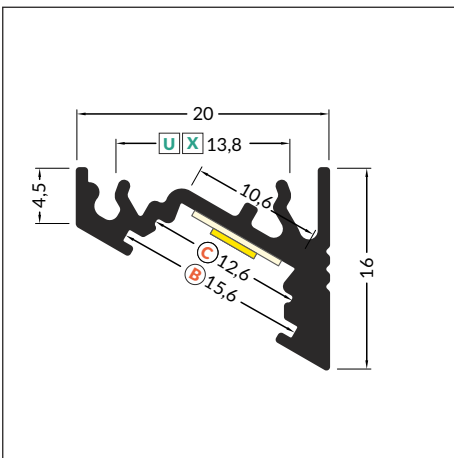
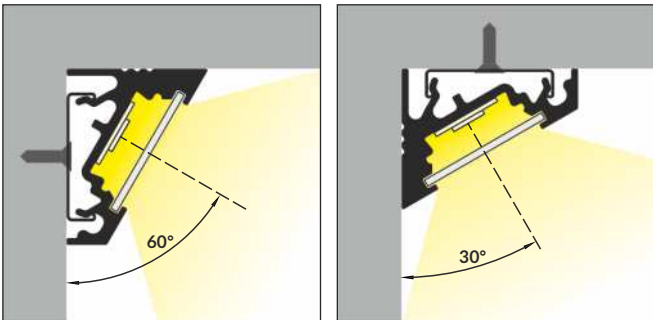
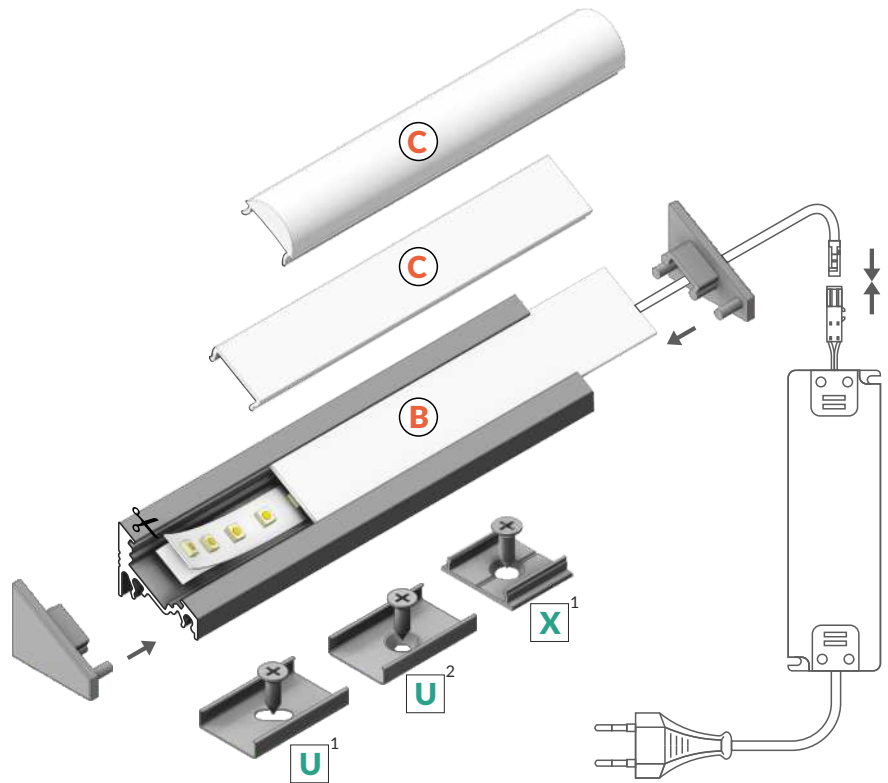



- B** slide cover
B
- C** click cover
C
- C** lens cover
C
- U**¹ U flexible mounting plate
- U**² cone U flexible mounting plate
- X**¹ X mounting plate



-  max 10 mm
-  corner



INDEX = 1 pc, length 2000 mm
package = 10 pcs

-  white painted
83050001
-  anodized
83050020
-  black anodized
83050021
-  raw aluminium
83050000

Available lengths: 1000 mm, 2000 mm, 3000 mm, 4000 mm.
The standard profile length tolerance is +2 mm.
For more details please see page 1.08.

ACCESSORIES



COVERS

B slide cover
 colours: transparent, frosted, opal
 material: PC, PP, PP

C click cover
 colours: transparent, opal
 material: PMMA

C click cover lens
 colour: transparent
 material: PC



Note! Dimensions of the space to install LED source

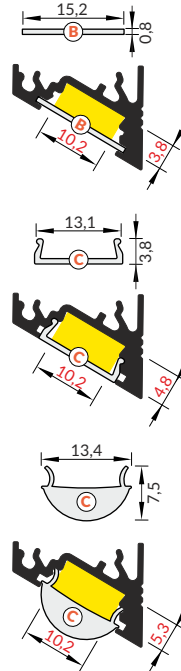

INDEX = 1 pc, length 2000 mm
 package = 10 pcs

B transparent
 76250016

B frosted
 76250039

B opal
 76250038

C transparent
 76330000

C opal
 76330038

C lens
 76300000

The standard cover length tolerance is +20 mm.
 For more details please see page 1.08.

ENDINGS

CORNER10 ending gen2
 colours: white, silver, black, grey
 material: ABS

CORNER10 ending gen2 with hole
 colours: white, silver, black, grey
 material: ABS

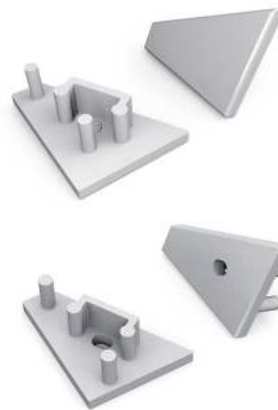
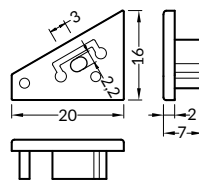
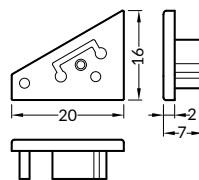

INDEX = 1 set
 package = 10 sets = 20 pcs

○ white
 with hole | without hole
 83980001 | 83990001

● silver
 with hole | without hole
 83980040 | 83990040

● black
 with hole | without hole
 83980002 | 83990002

● grey
 with hole | without hole
 83980022 | 83990022

CONNECTORS

X connector 180 deg
 colour: raw aluminium
 material: aluminium

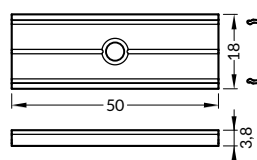

INDEX = 1 set

X connector

● raw aluminium
 76350000

ACCESSORIES



CORNER10 connector 90 deg
 colours: white, anodized, black
 material: aluminium

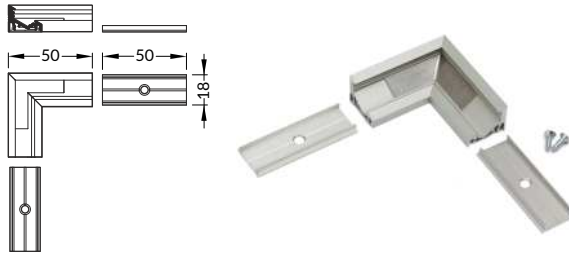

connector 90 deg

- white painted
83110001
- anodized
83110020
- black anodized
83110021

MOUNTINGS

U flexible mounting plate
 colours: inox
 material: stainless steel

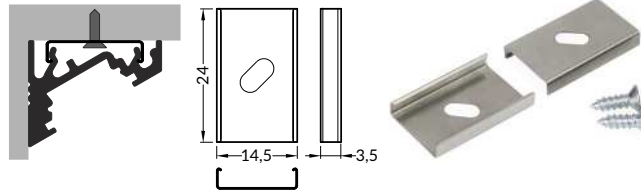

INDEX = 1 set
 package = 10 sets = 20 pcs

U flexible mounting plate

- inox 76380000

cone U flexible mounting plate
 colours: inox
 material: stainless steel

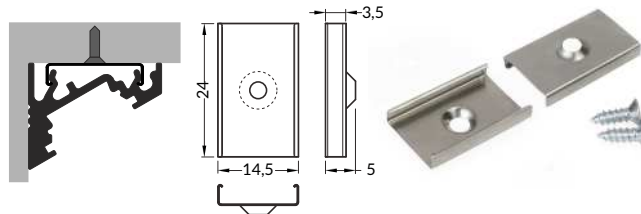

cone U flexible mounting plate

- inox 76620000

X mounting plate
 colours: raw aluminium
 material: aluminium

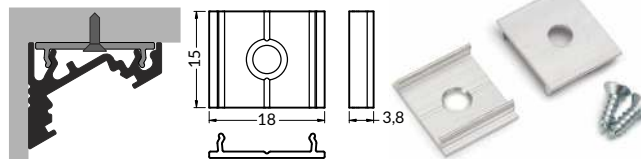

X mounting plate

- raw aluminium
76260000

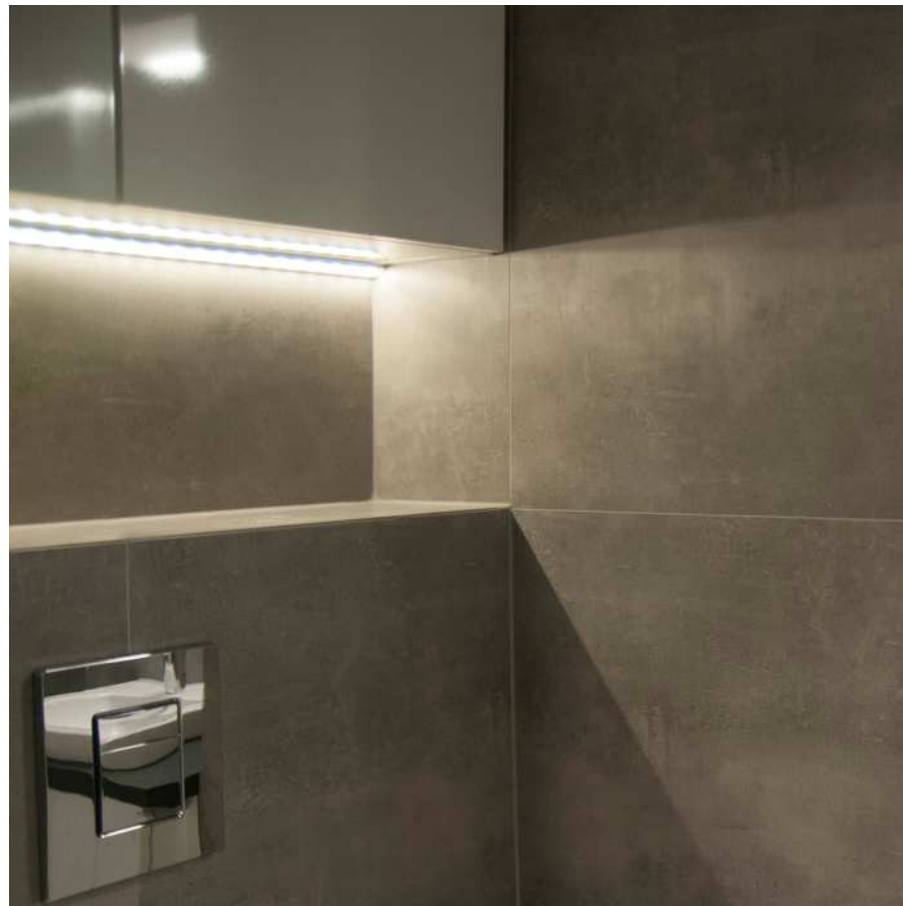

QUARTER10 BD/U6

LIGHT FROM AN ANGLE

- full circle quadrant illumination
- LED strip aligned to 45° angle
- Slick socket
- maximum LED strip width: 10 mm



SIMILAR IN THE OFFER



TRIO10
BC



CORNER10
BC/UX



CABI12
E



CORNER14
EF/TY



CORNER27
G/UX



- B** slide cover
B
- D** click cover
D
- U6**¹ U6 mounting plate
- U6**² cone U6 mounting plate

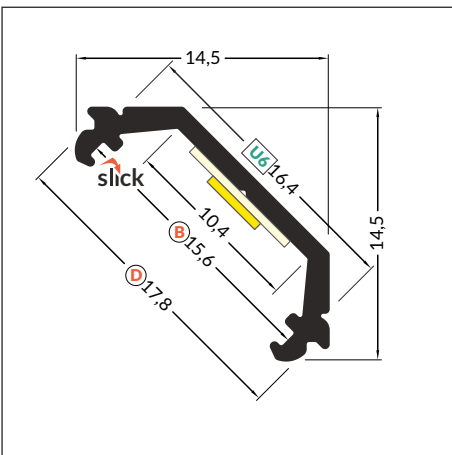
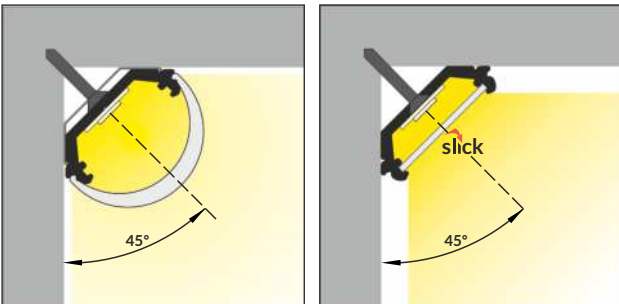
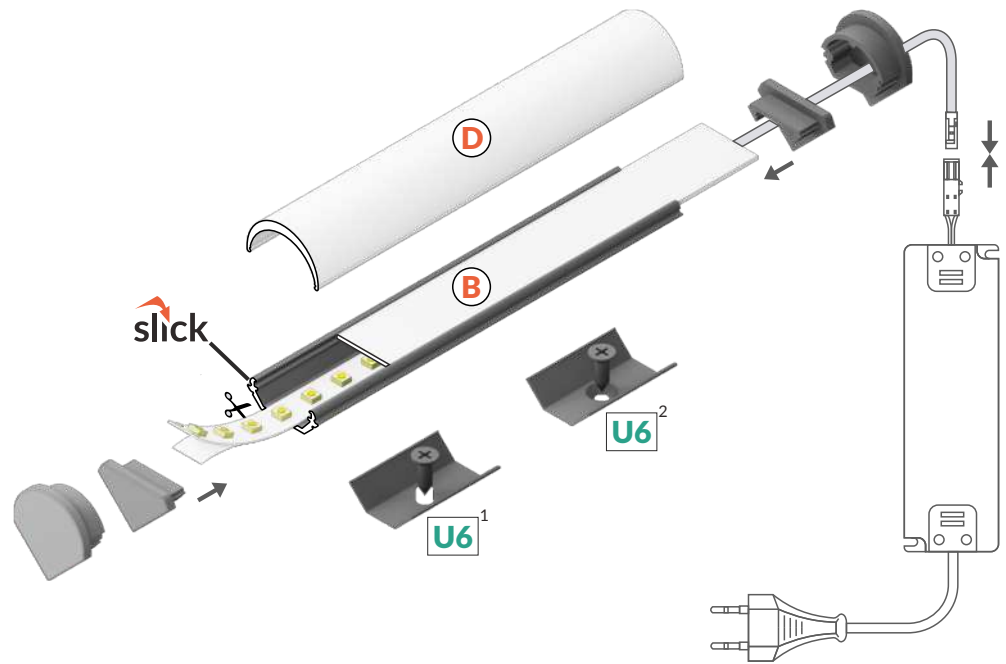

- max 10 mm
- corner

INDEX = 1 pc, length 2000 mm
package = 10 pcs

anodized
D3020020

Available lengths: 1000 mm, 2000 mm, 3000 mm, 4000 mm.
The standard profile length tolerance is +2 mm.
For more details please see page 1.08.

ACCESSORIES



COVERS

B slide cover
 colours: transparent, frosted, opal
 material: PC, PP, PP

D click cover
 colour: opal
 material: PMMA



Note! Dimensions of the space to install LED source

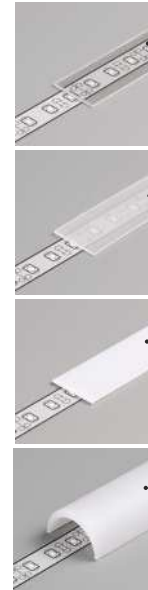
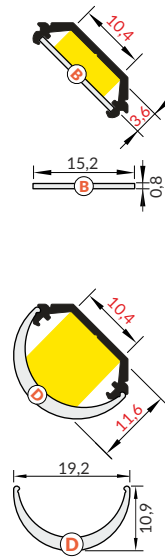

INDEX = 1 pc, length 2000 mm
 package = 10 pcs

B transparent
 76250016

B frosted
 76250039

B opal
 76250038

D opal
 A1140038

The standard cover length tolerance is +20 mm.
 For more details please see page 1.08.

ENDINGS

QUARTER10 ending
 colours: silver, grey
 material: ABS

QUARTER10 D ending
 colours: silver, grey
 material: ABS



Ending with marked space to bore the holes.

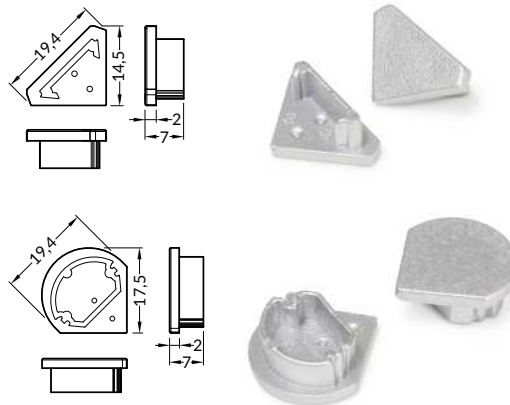

INDEX = 1 set
 package = 10 sets = 20 pcs

● silver D3980040
 ● grey D3980022

● silver D3990040
 ● grey D3990022

MOUNTINGS

U6 mounting plate
 colours: inox
 material: stainless steel

cone **U6** mounting plate
 colours: inox
 material: stainless steel

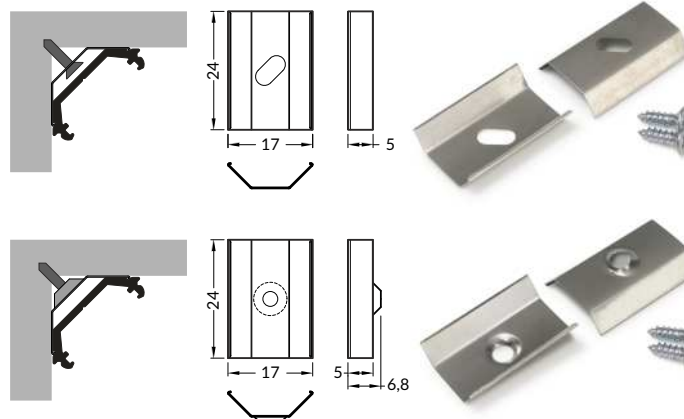

INDEX = 1 set
 package = 10 sets = 20 pcs

U6 mounting plate
 ● inox D3960019

cone **U6** mounting plate
 ● inox D3970019



A PROFILE FOR SHOW CASE'S INSIDE VERTICAL AND HORIZONTAL ILLUMINATION

- two lighting angles: 30°/60°
- small sizes, no holders and a channel for hiding cables
 - minimum interference in glass show case's look
- Slick socket
- maximum LED strip width: 12 mm

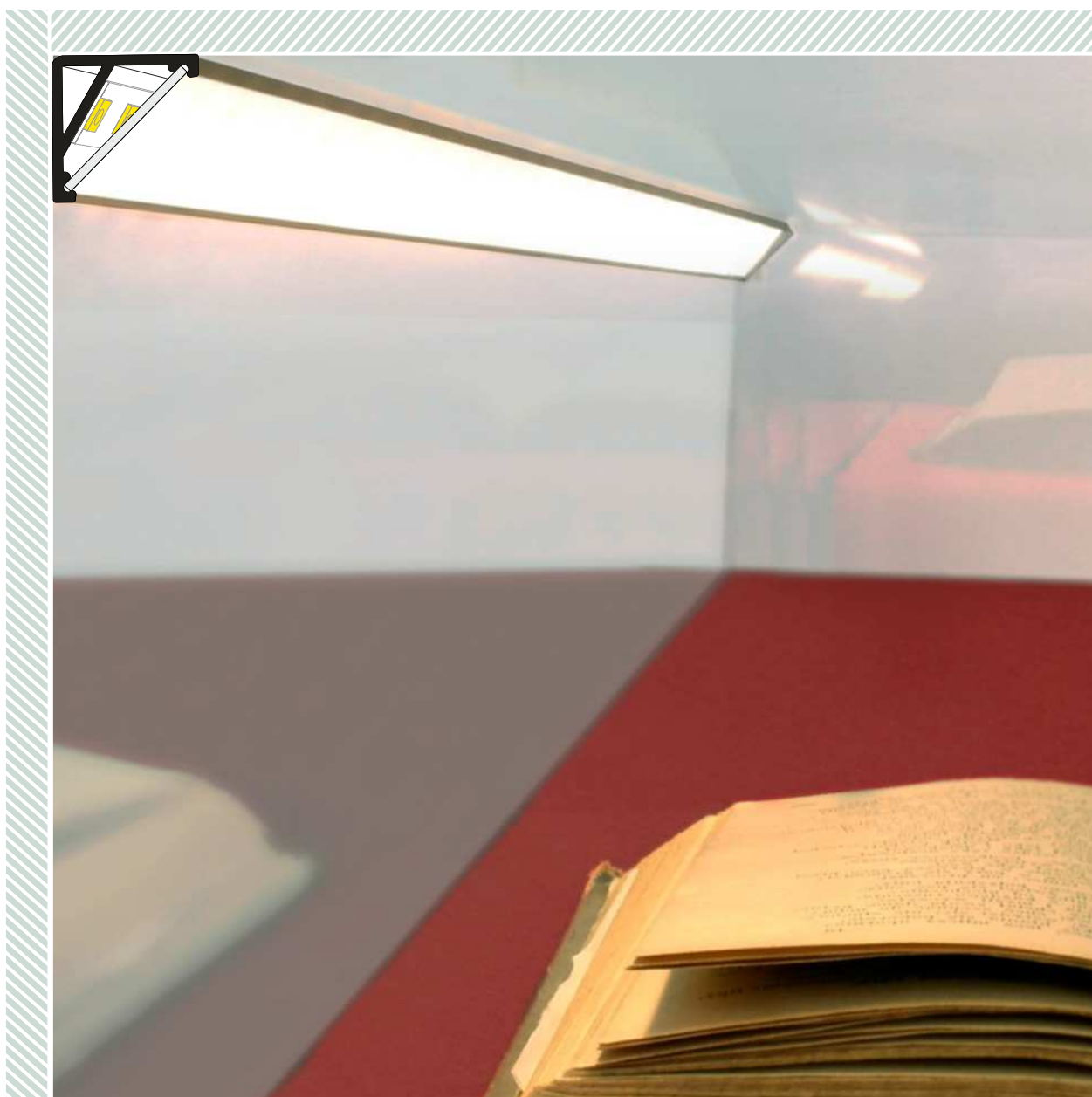

SIMILAR IN THE OFFER





E E slide cover

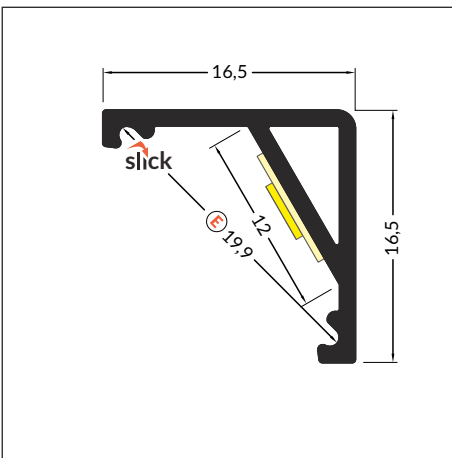
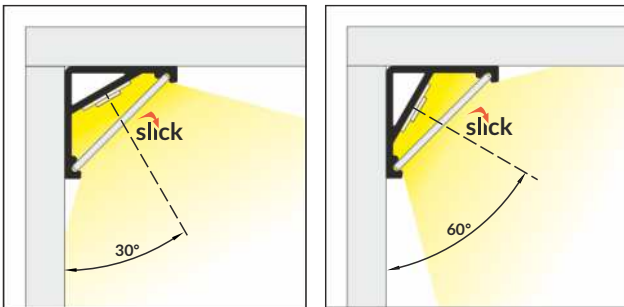
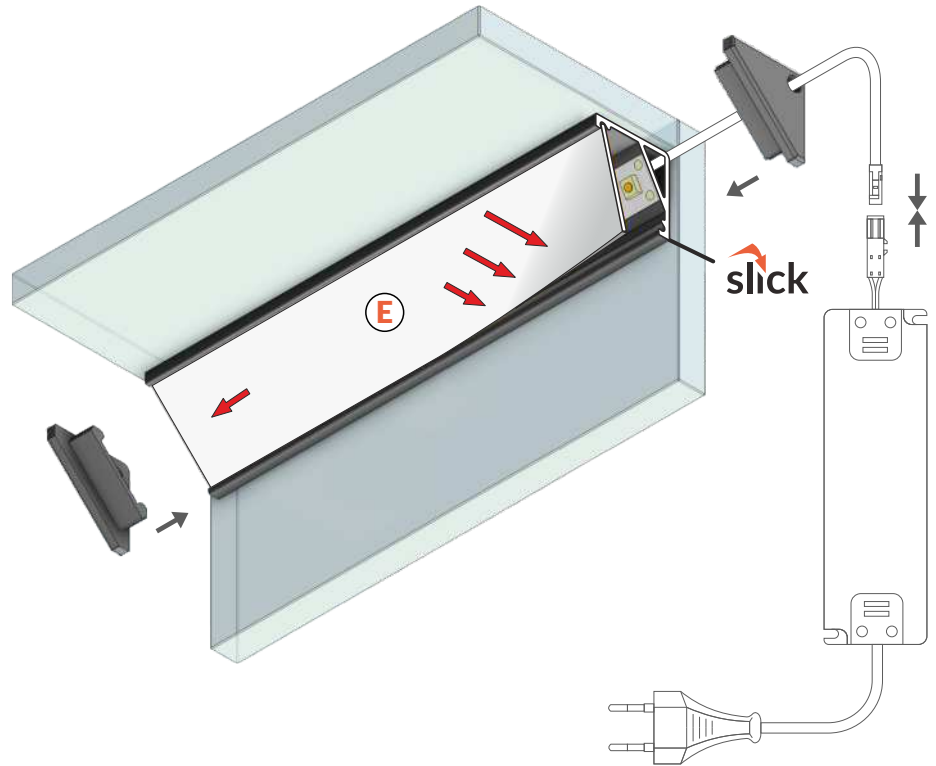

INDEX = 1 pc, length 2000 mm
package = 10 pcs

○ white painted
C9020001

● anodized
C9020020

● black anodized
C9020021

● raw aluminium
C9020000

○ max 12 mm

○ corner

Available lengths: 1000 mm, 2000 mm.
The standard profile length tolerance is +2 mm.
For more details please see page 1.08.

ACCESSORIES



COVERS

E slide cover
 colours: transparent, frosted, opal
 material: PC, PP, PP



Note! Dimensions of the space to install LED source

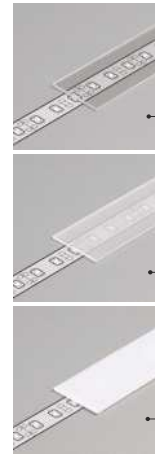
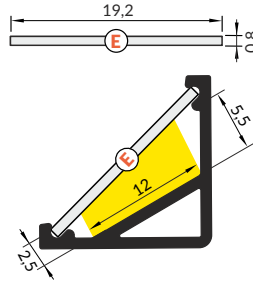

INDEX = 1 pc, length 2000 mm
 package = 10 pcs

E transparent
 A2040016

E frosted
 A2040039

E opal
 A2040038

The standard cover length tolerance is +20 mm.
 For more details please see page 1.08.

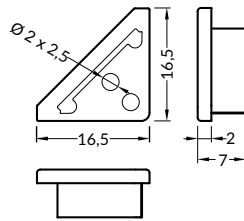

ENDINGS

CABI12 ending
 colours: white, silver, black, grey
 material: ABS



Ending with marked space to bore the holes.

INDEX = 1 set
 package = 10 sets = 20 pcs

-  white C9980001
-  silver C9980040
-  black C9980002
-  grey C9980022



INVISIBLE WIRES

Special channel to hide the wires allows to remain esthetic look of the showcase.



EQUAL SIDE LENGTHS

The symmetrical profile design allows precise connections in a different configurations.

CORNER14 EF/TY

ANGULAR PROFILE 30°/60°

- hidden mounting
- two lighting angles: 30°/60°
- maximum LED strip width: 14 mm



SIMILAR IN THE OFFER



TRIO10
BC



CORNER10
BC/UX



QUARTER10
BD/U6



CABI12
E







CORNER27
G/UX

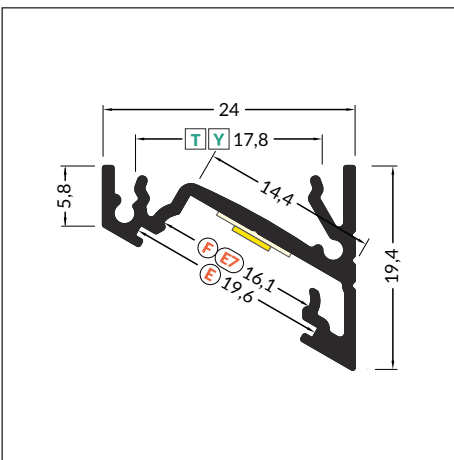
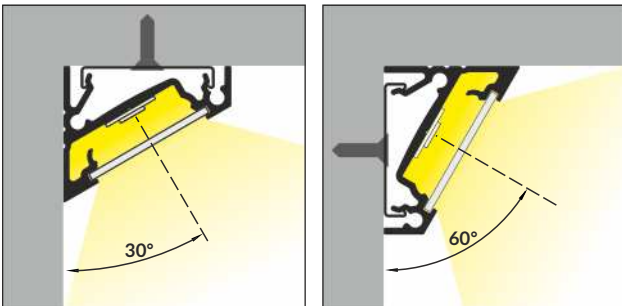
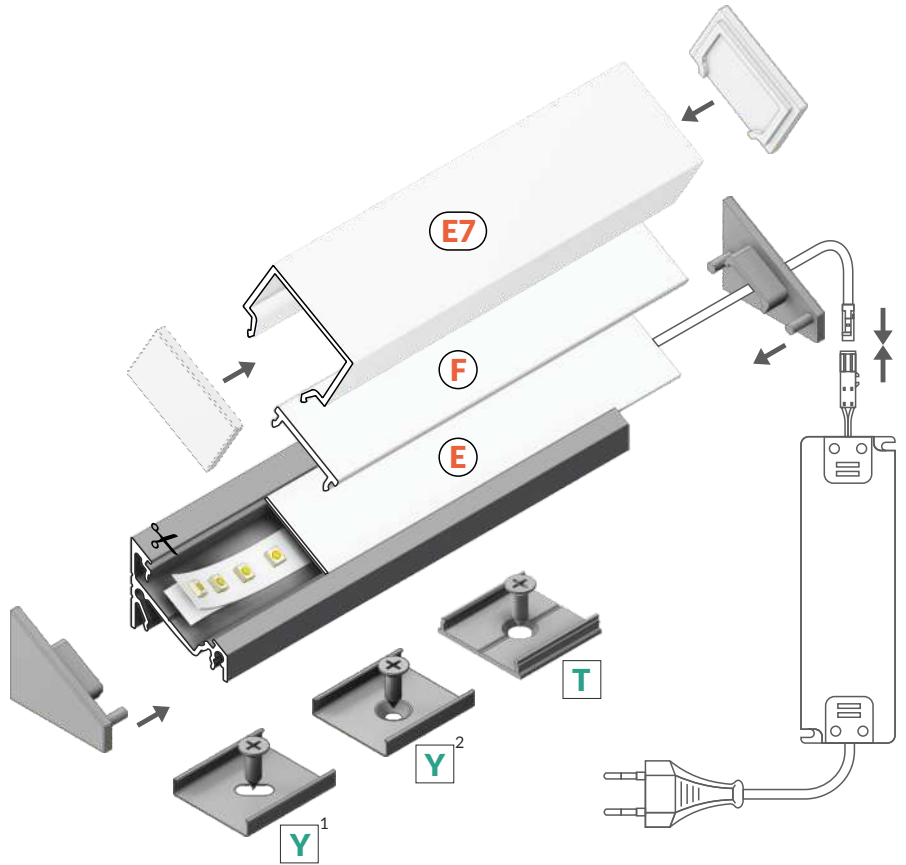

- E** slide cover
- F** click cover
- E7** E7 click cover
- Y¹** Y flexible mounting plate
- Y²** cone Y flexible mounting plate
- T** T mounting plate



INDEX = 1 pc, length 2000 mm
package = 10 pcs

-  white painted
A4020001
-  anodized
A4020020
-  black anodized
A4020021
-  raw aluminium
A4020000

Available lengths: 1000 mm, 2000 mm, 3000 mm, 4000 mm.
The standard profile length tolerance is +2 mm.
For more details please see page 1.08.

ACCESSORIES



COVERS

E slide cover
 colours: transparent, frosted, opal
 material: PC, PP, PP



Note! Dimensions of the space to install LED source

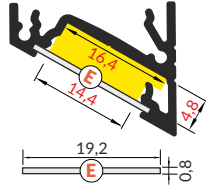

F click cover
 colours: transparent, opal
 material: PMMA

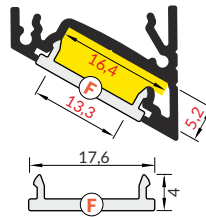

E7 click cover
 colour: opal
 material: PMMA

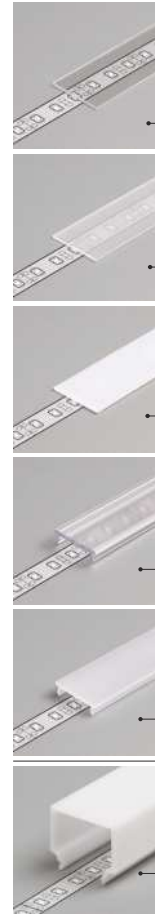
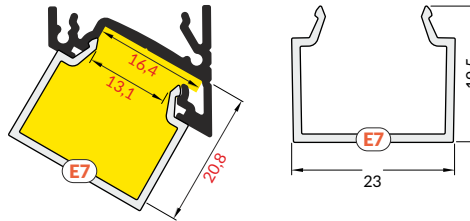

INDEX = 1 pc, length 2000 mm
 package = 10 pcs

E transparent
 A2040016

E frosted
 A2040039

E opal
 A2040038

F transparent
 A2060016

F opal
 A2060038

E7 opal
 C1080038

The standard cover length tolerance is +20 mm.
 For more details please see page 1.08.

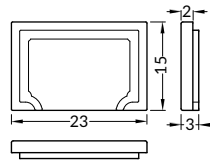

INDEX = 1 set
 package = 10 sets = 20 pcs

E7 opal ending

C1840038

MOUNTING

Y flexible mounting plate
 colour: inox
 material: stainless steel

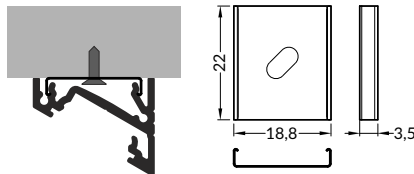

cone **Y** flexible mounting plate
 colour: inox
 material: stainless steel

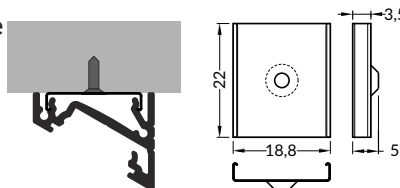

T mounting plate
 colour: raw aluminium
 material: aluminium

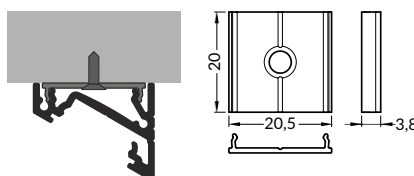

INDEX = 1 set
 package = 10 sets = 20 pcs

Y flexible mounting plate

inox A2090019

cone **Y** flexible mounting plate

inox A2130019

T mounting plate

raw aluminium C6960000

ACCESSORIES



ENDINGS

CORNER14 ending gen2
 colours: white, silver, black, grey
 material: ABS

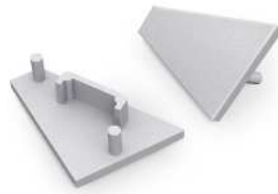
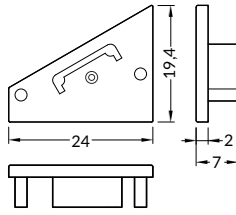

CORNER14 ending gen2 with hole
 colours: white, silver, black, grey
 material: ABS

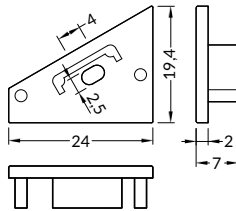

INDEX = 1 set
 package = 10 sets = 20 pcs

- | | |
|-----------------|-----------------|
| ○ white | |
| with hole | without hole |
| A4970001 | A4980001 |
| ● silver | |
| with hole | without hole |
| A4970040 | A4980040 |
| ● black | |
| with hole | without hole |
| A4970002 | A4980002 |
| ● grey | |
| with hole | without hole |
| A4970022 | A4980022 |

CONNECTORS

T connector 180 deg
 colour: raw aluminium
 material: aluminium

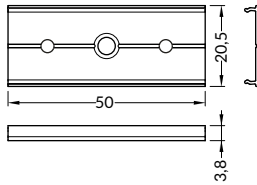

CORNER14 connector 90 deg
 colours: white, anodized, black
 material: aluminium

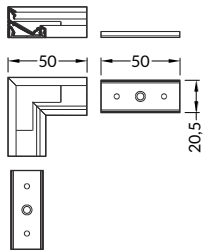

INDEX = 1 set

T connector

● raw aluminium
C6990000

connector 90 deg

- | | |
|------------------|--|
| ○ white painted | |
| A4990001 | |
| ● anodized | |
| A4990020 | |
| ● black anodized | |
| A4990021 | |



CORNER27 G/UX

LARGE-SIZE ANGULAR PROFILE

- hidden mounting
- two lighting angles: 30° or 60°
- maximum LED strip width: 27 mm or 3 standard strips (8 mm)

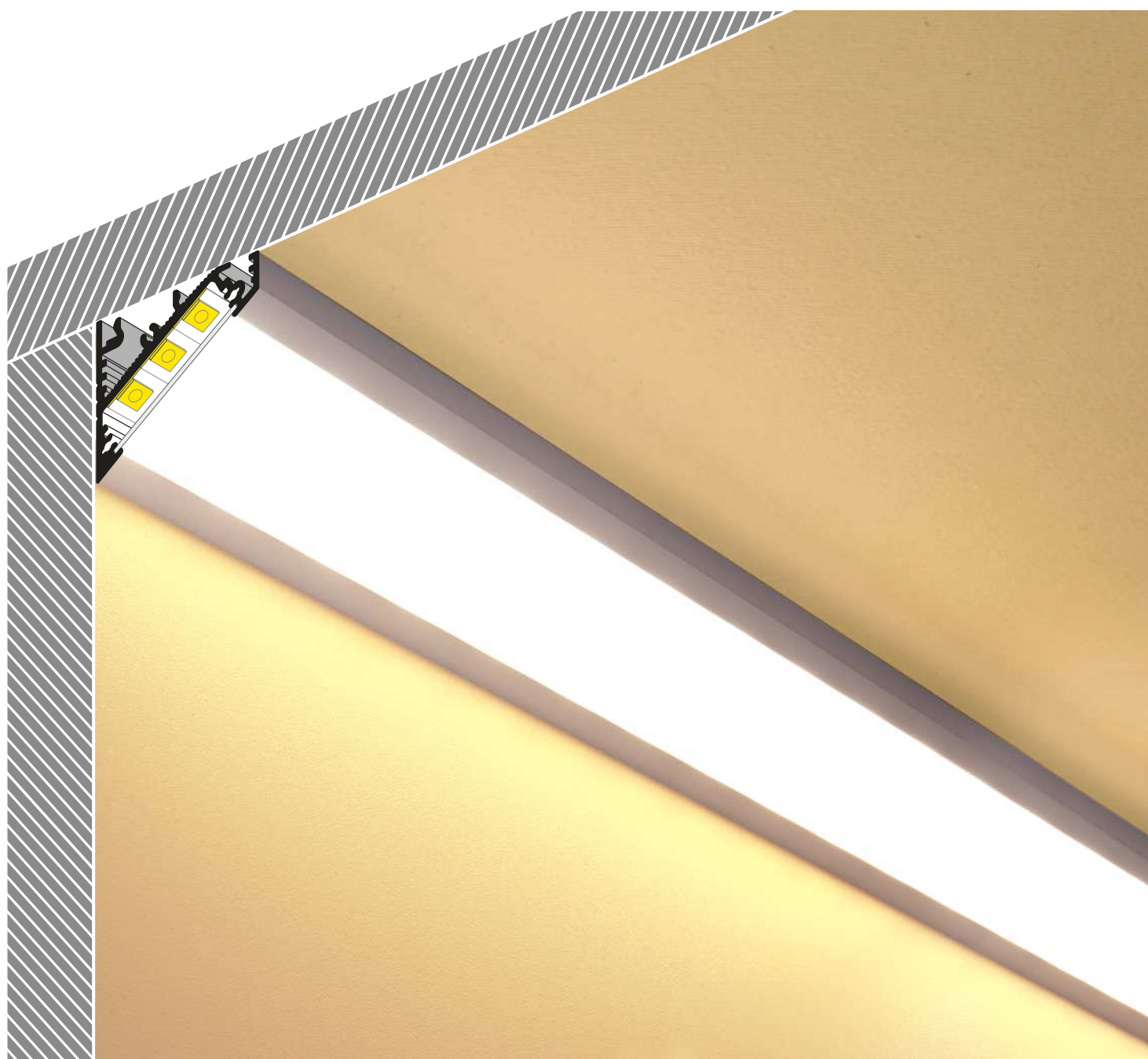

SIMILAR IN THE OFFER



TRIO10
BC



CORNER10
BC/UX



QUARTER10
BD/U6



CABI12
E



CORNER14
EF/TY



G slide cover

U¹ U flexible mounting plate

U² cone U flexible mounting plate

X¹ X mounting plate

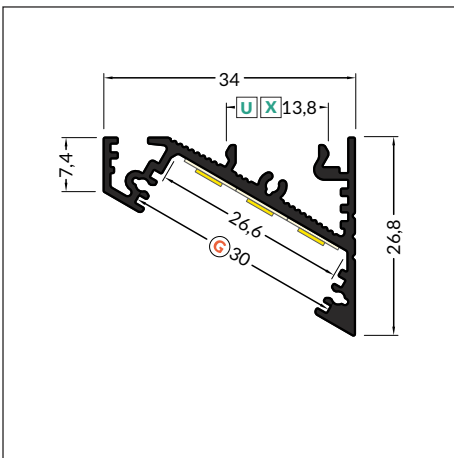
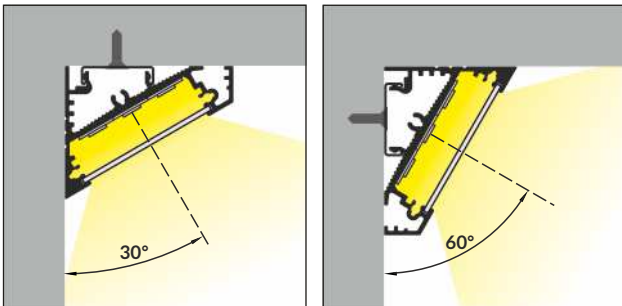
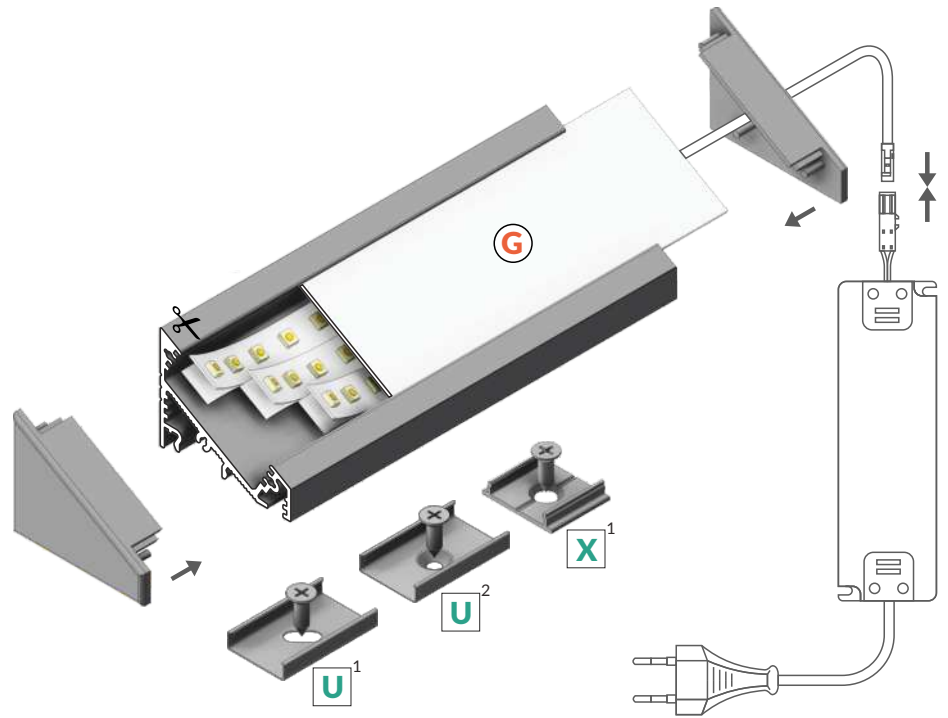

 max 27 mm

 corner



INDEX = 1 pc, length 2000 mm
package = 10 pcs

 white painted
98030001



 anodized
98030020



 black anodized
98030021

Available lengths: 1000 mm, 2000 mm, 3000 mm, 4000 mm.
The standard profile length tolerance is +2 mm.
For more details please see page 1.08.



COVERS

G slide cover
 colours: transparent, frosted, opal
 material: PC, PP, PP

Note! Dimensions of the space to install LED source

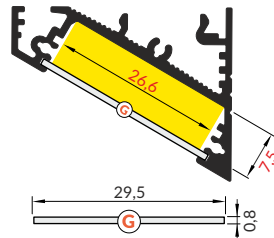

INDEX = 1 pc, length 2000 mm
 package = 10 pcs

G transparent
 84070016

G frosted
 84070039

G opal
 84070038

The standard cover length tolerance is +20 mm.
 For more details please see page 1.08.

ENDINGS

CORNER27 ending
 colours: white, silver, black, grey
 material: ABS

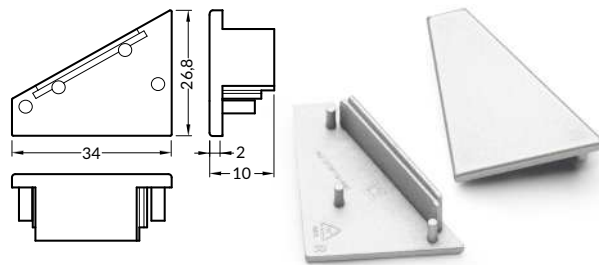

INDEX = 1 set
 package = 10 sets = 20 pcs

-  white 98050001
-  silver 98050040
-  black 98050002
-  grey 98050022

MOUNTINGS

U flexible mounting plate
 colour: inox
 material: stainless steel

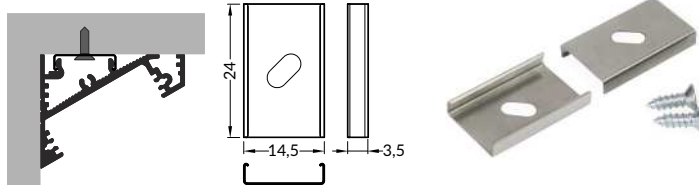

cone **U** flexible mounting plate
 colour: inox
 material: stainless steel

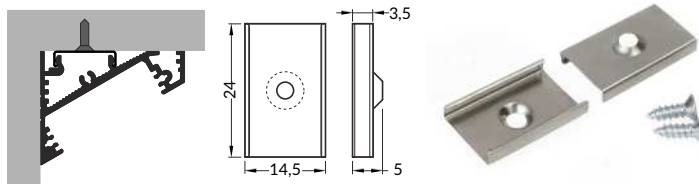

X mounting plate
 colour: raw aluminium
 material: aluminium

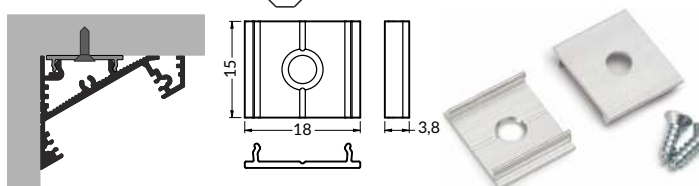

INDEX = 1 set
 package = 10 sets = 20 pcs

U flexible mounting plate

 inox
 76380000

cone **U** flexible mounting plate

 inox
 76620000

X mounting plate

 raw aluminium
 76260000



CONNECTORS

X connector 180 deg
colour: raw aluminium
material: aluminium

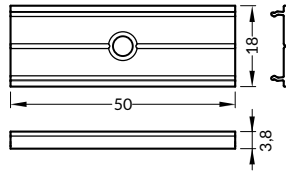

INDEX = 1 set

raw aluminium
76350000



PEN8 |

MULTI-PURPOSE ALUMINIUM PROFILE

- decorative and lighting profile, eg. for glass cabinets
- 9 types of mountings: for horizontal or vertical lighting (also with adjustment)
- possibility of mounting between the walls of a cabinet
- maximum LED strip width: 8 mm

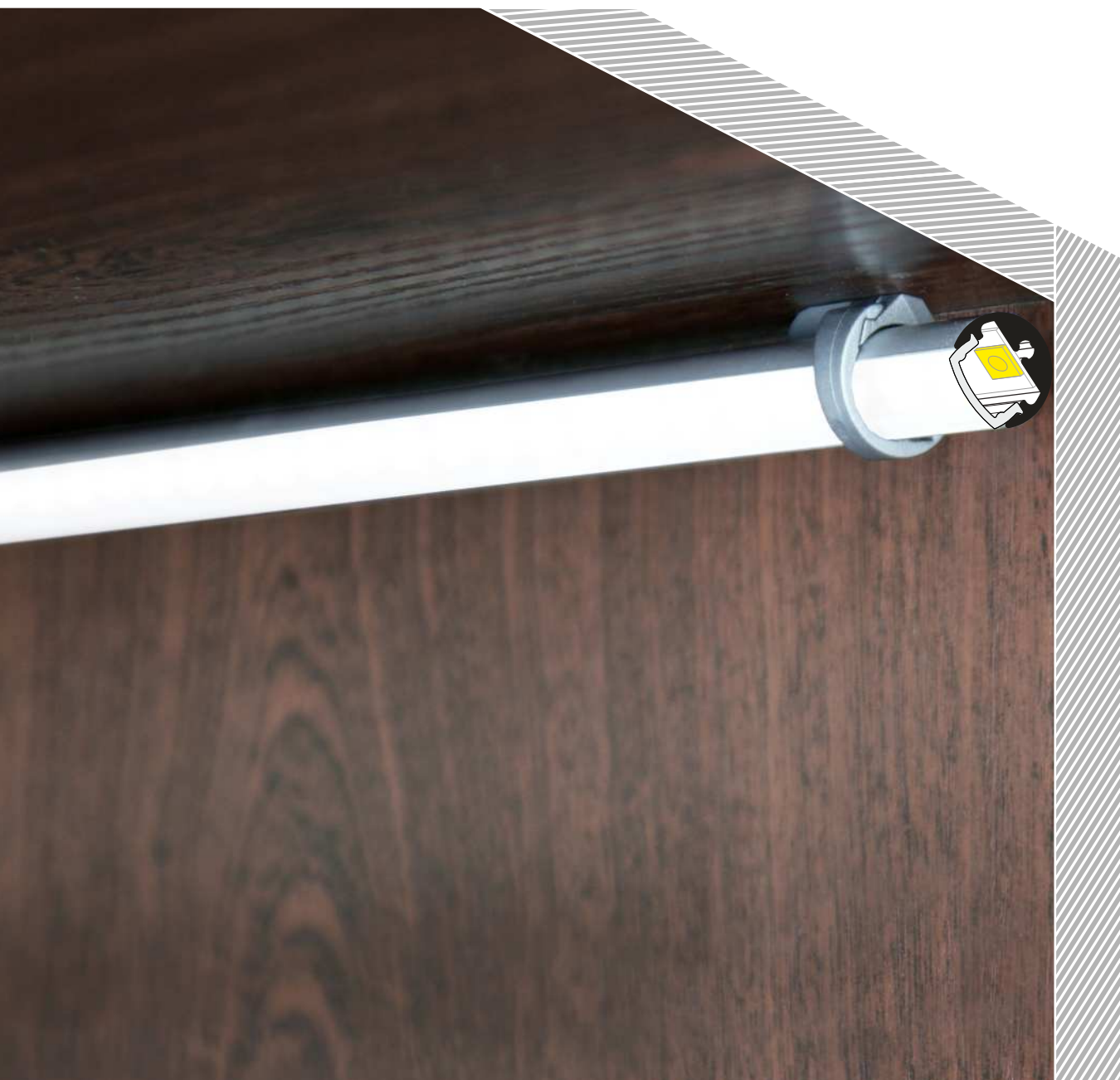

SIMILAR IN THE OFFER





 click cover

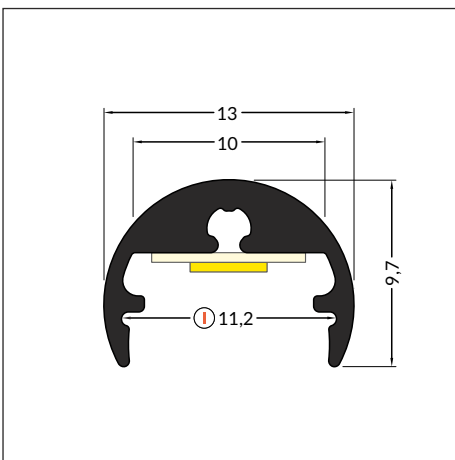
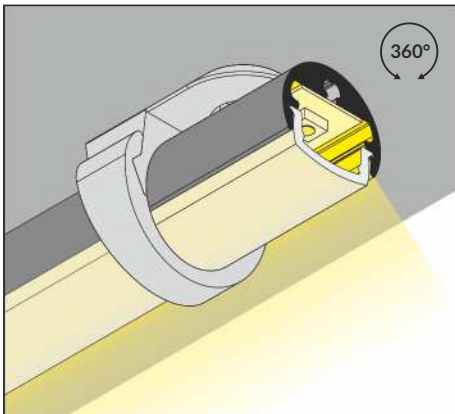
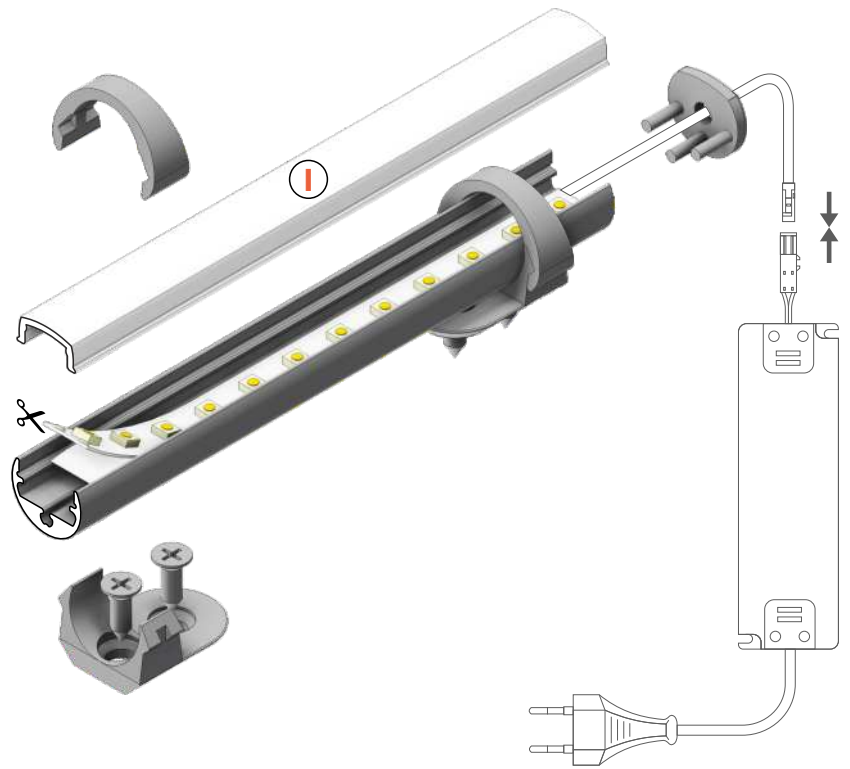

INDEX = 1 pc, length 2000 mm
package = 10 pcs

 anodized
86030020

Available lengths: 1000 mm, 2000 mm, 3000 mm, 4000 mm.
The standard profile length tolerance is +2 mm.
For more details please see page 1.08.

 max 8 mm

 special application

ACCESSORIES



COVERS

click cover
colour: frosted, opal
material: PC



Note! Dimensions of the space to install LED source

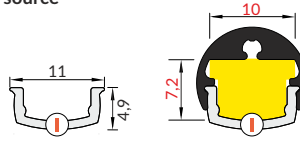

INDEX = 1 pc, length 2000 mm
package = 10 pcs

frosted
86060000

opal
86060038

The standard cover length tolerance is +20 mm.
For more details please see page 1.08.

ENDINGS

PEN8 ending
colours: silver, grey
material: ABS

PEN8 ending with hole
colours: silver, grey
material: ABS

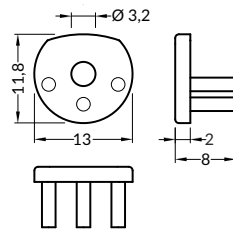

INDEX = 1 set
package = 10 sets = 20 pcs

silver
with hole | without hole
86470040 | 86490040

grey
with hole | without hole
86470022 | 86490022

MOUNTINGS

PEN8 flat holder
colour: grey
material: ABS

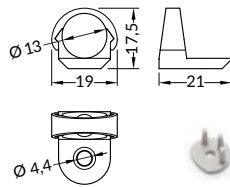
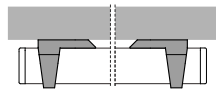

INDEX = 1 set
package = 10 sets = 20 pcs

flat holder

grey
86070022

INDEX = 1 set

PEN8 simple holder
material: zinc coated steel

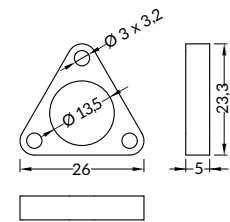
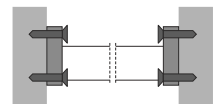

simple holder

zinc coated
86370030

PEN8 stretcher holder
colour: chrome
material: brass

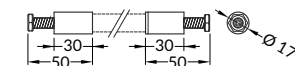
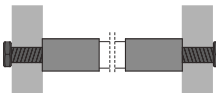

stretcher holder

chrome
86290003

PEN8 end holder
colour: chrome
material: brass

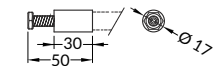
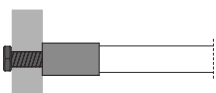

end holder

chrome
86160003

PEN8 ring holder
colours: chrome, raw
material: brass

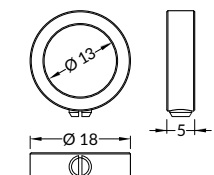
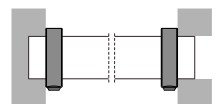

ring holder

chrome
86440003

ACCESSORIES



MOUNTINGS

PEN8 jointed holder with thread
 colour: chrome
 material: steel, brass

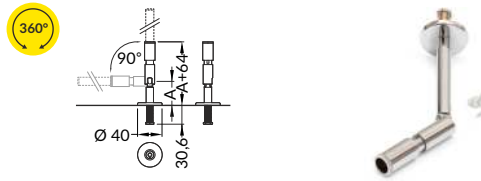

A =	INDEX = 1 set
39,4 mm	86090003
100 mm	86310003
200 mm	86110003
300 mm	86130003

PEN8 jointed holder with soffit ceiling
 colour: chrome
 material: steel, brass

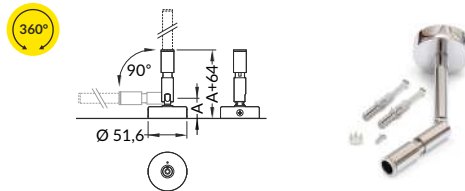

A =	INDEX = 1 set
27 mm	86080003
100 mm	86300003
200 mm	86100003
300 mm	86120003

PEN8 double holder with thread
 colour: chrome
 material: steel, brass

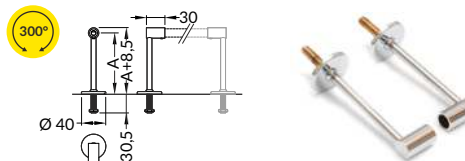

A =	INDEX = 1 set
100 mm	86330003
200 mm	86180003
300 mm	86200003

PEN8 double holder with soffit ceiling
 colour: chrome
 material: steel, brass

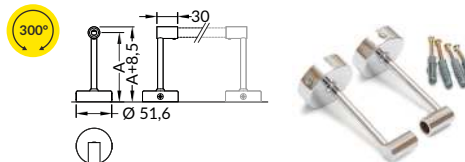

A =	INDEX = 1 set
100 mm	86320003
200 mm	86170003
300 mm	86190003



BACK10 A/UX

TWO LIGHTING DIRECTIONS

- decorative illumination
- the T-shaped structure makes possible to direct the light beam in two directions (up/down, left/right)
- mounting with two dedicated holders (to the wall) or directly to the piece of furniture, using screws
- optionally, the A cover can be used
- maximum LED strip width: 10 mm

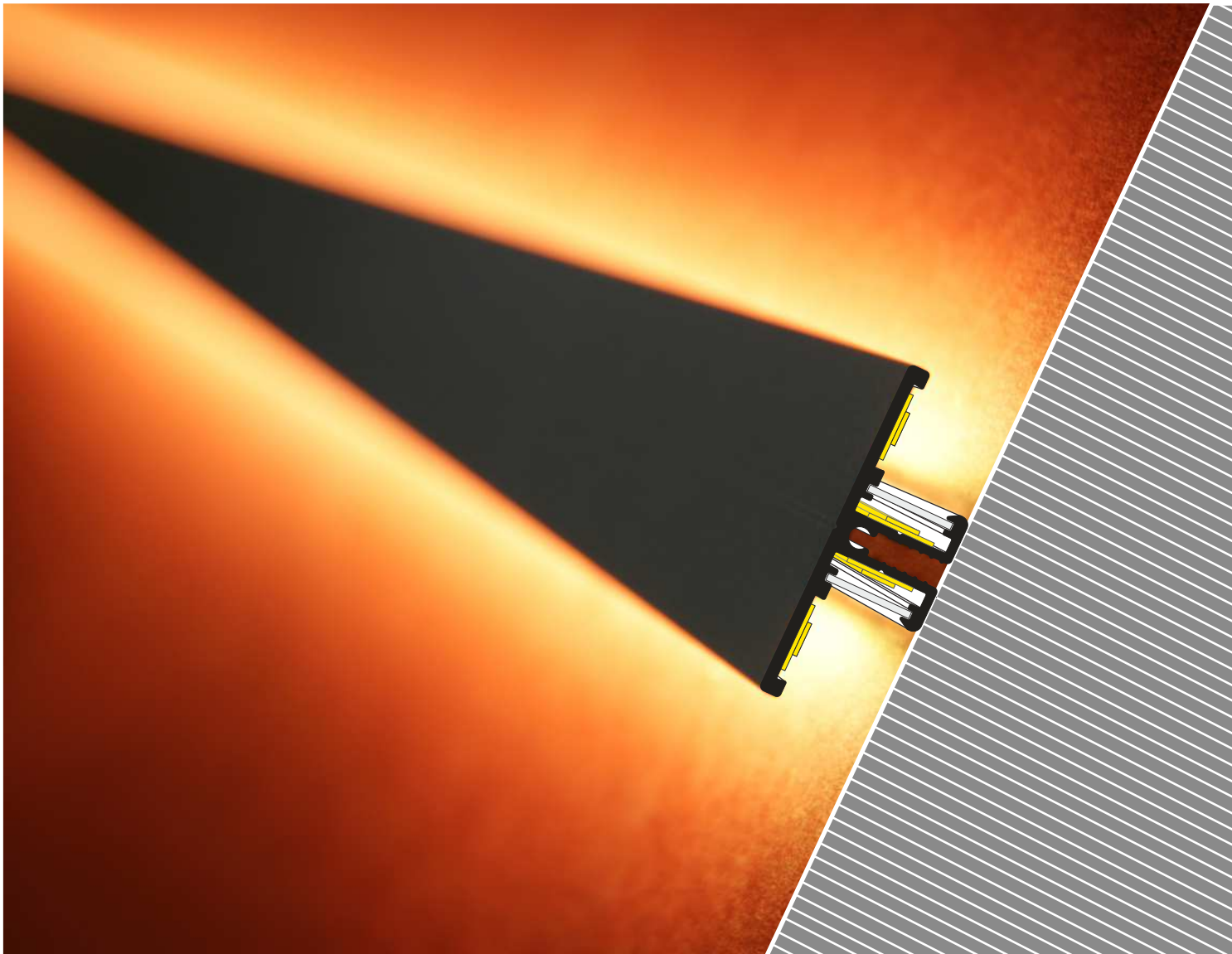

SIMILAR IN THE OFFER



TWIN8



AMBI12
C



WALLE12
CD



- A** slide cover
- U¹** U flexible mounting plate
- U²** cone U flexible mounting plate
- X¹** X mounting plate

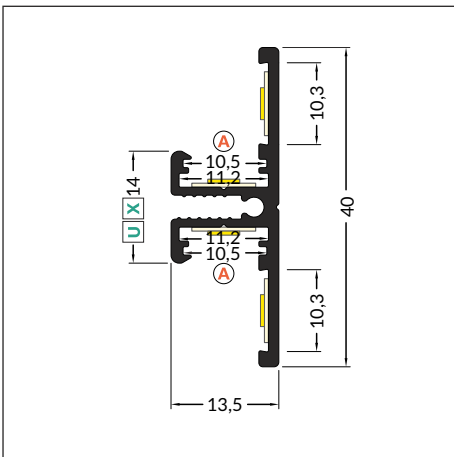
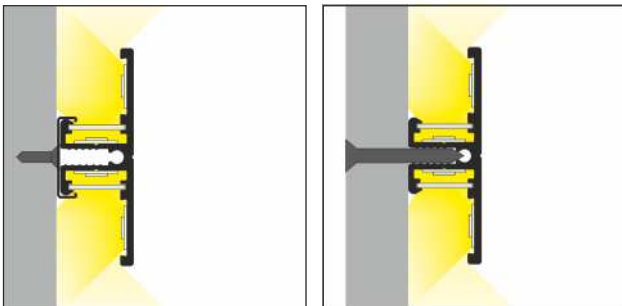
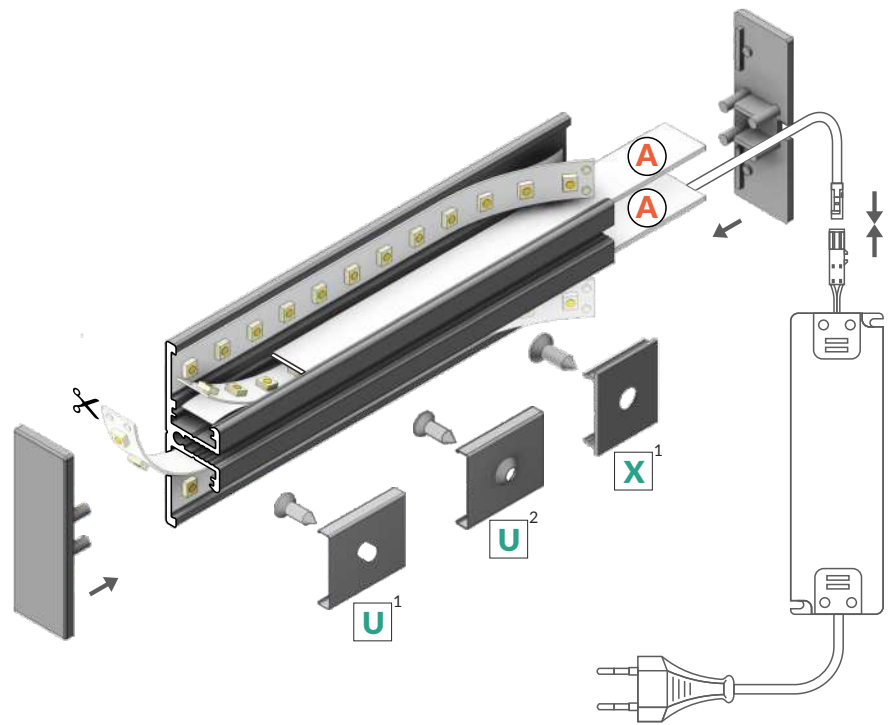





max 10 mm



special application



INDEX = 1 pc, length 2000 mm
package = 10 pcs

-  white painted
90030001
-  anodized
90030020
-  black painted
90030002
-  raw aluminium
90030000

Available lengths: 1000 mm, 2000 mm, 3000 mm, 4000 mm.
The standard profile length tolerance is +2 mm.
For more details please see page 1.08.

ACCESSORIES



COVERS

A slide cover
 colours: transparent, frosted, opal
 material: PC, PP, PP

Note! Dimensions of the space to install LED source

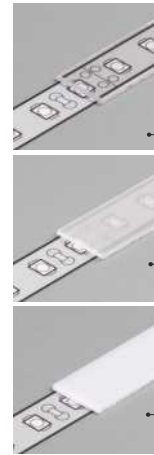
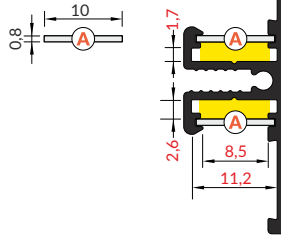

INDEX = 1 pc, length 2000 mm
 package = 10 pcs

A transparent
 89070016

A frosted
 89070039

A opal
 89070038

The standard cover length tolerance is +20 mm.
 For more details please see page 1.08.

ENDINGS

BACK10 ending
 colours: white, silver, black, grey
 material: ABS

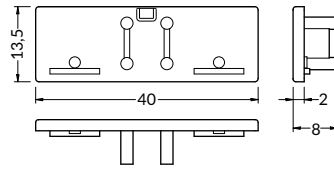

BACK10 ending with hole
 colours: white, silver, black, grey
 material: ABS

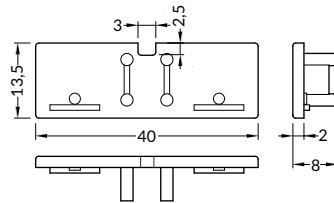

INDEX = 1 set
 package = 10 sets = 20 pcs

- white
 - with hole | 90150001
 - without hole | 90100001
- silver
 - with hole | 90150040
 - without hole | 90100040
- black
 - with hole | 90150002
 - without hole | 90100002
- grey
 - with hole | 90150022
 - without hole | 90100022

MOUNTINGS

U flexible mounting plate
 colour: inox
 material: stainless steel

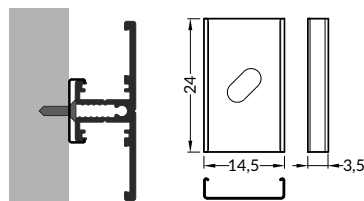

cone **U** flexible mounting plate
 colour: inox
 material: stainless steel

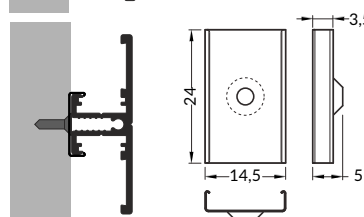

X mounting plate
 colour: raw aluminium
 material: aluminium

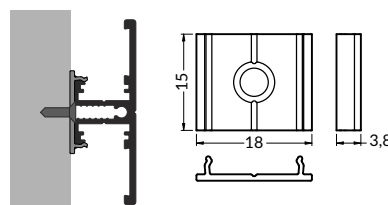

INDEX = 1 set
 package = 10 sets = 20 pcs

- U** flexible mounting plate
 - inox | 76380000
- cone **U** flexible mounting plate
 - inox | 76620000
- X** mounting plate
 - raw aluminium | 76260000

ACCESSORIES



CONNECTORS

X connector 180 deg
colour: raw aluminium
material: aluminium

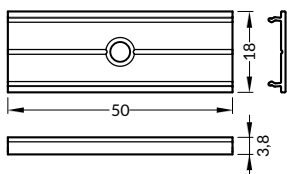

INDEX = 1 set

raw aluminium
76350000



STEP10 C

STEP EDGE PROFILE

- highlighting or illuminating feature
- 2 mounting options - 3 lighting options to choose from
- anti slip insert installation option
- hidden mounting
- impact resistant
- maximum LED strip width: 10 mm

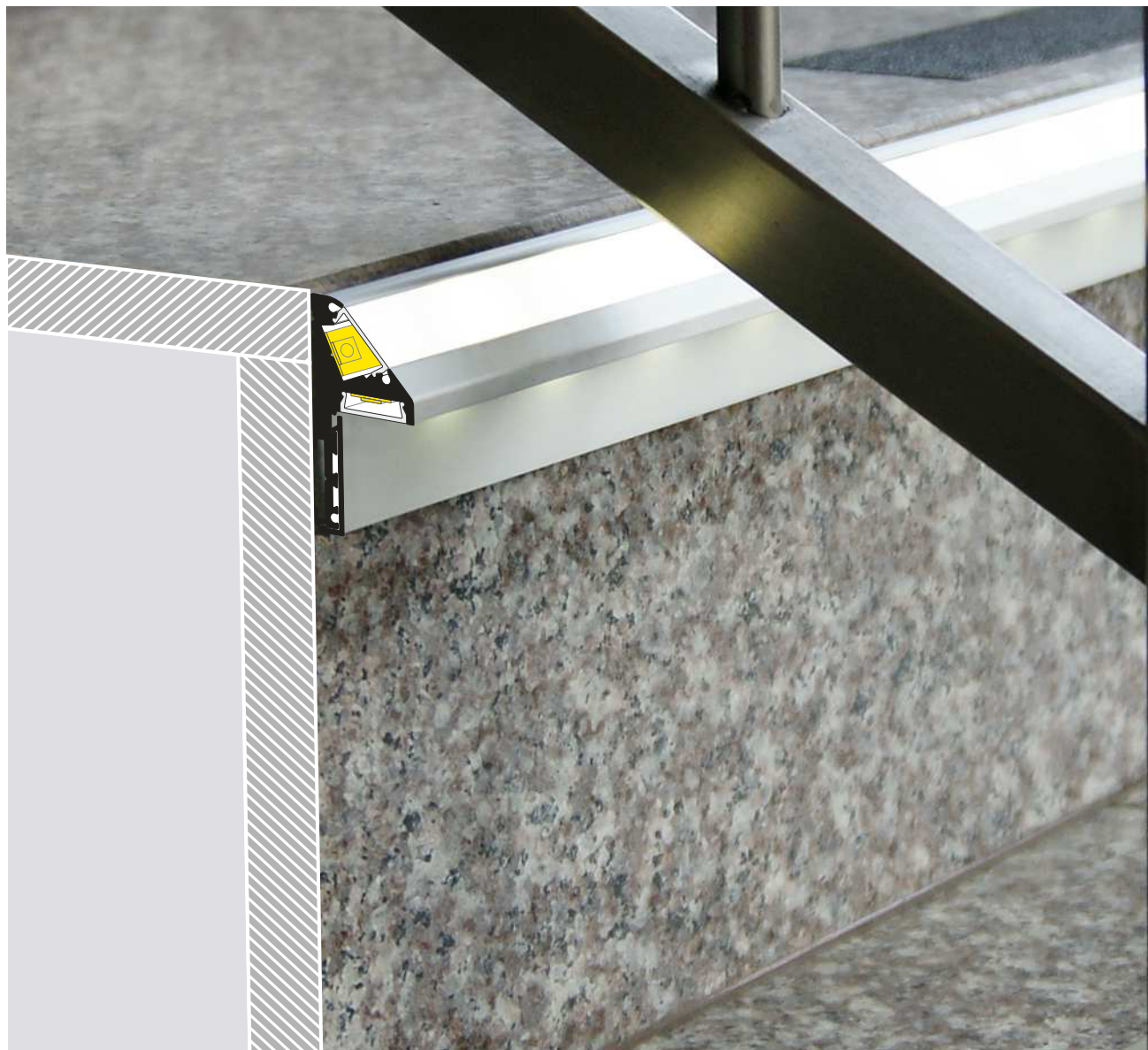

SIMILAR IN THE OFFER



FLOOR12
K/U



OUTSTAIRS12
BC



C click cover

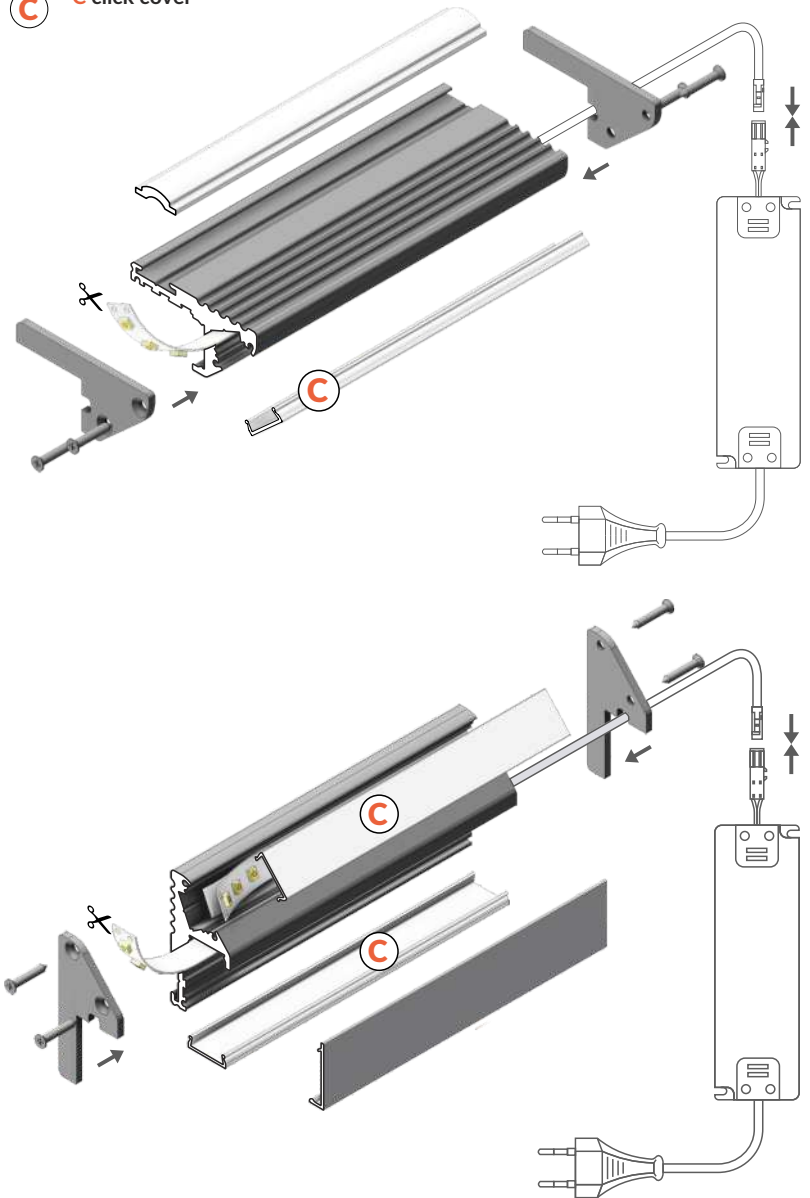
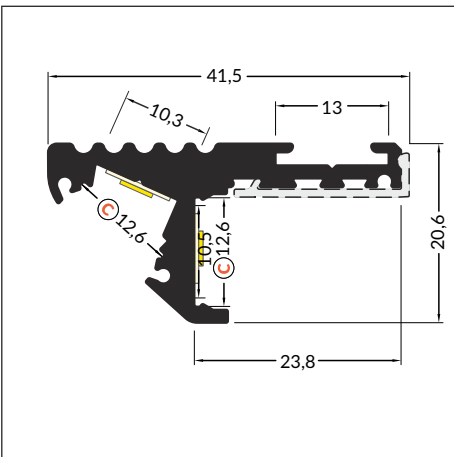
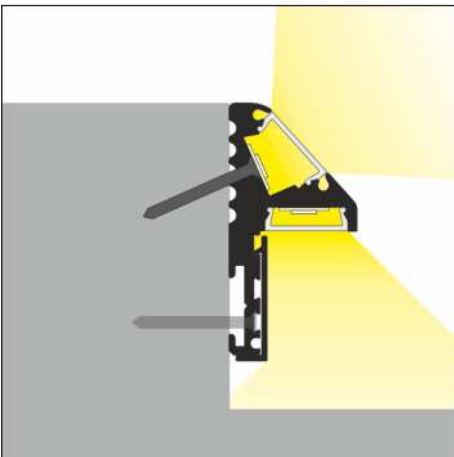
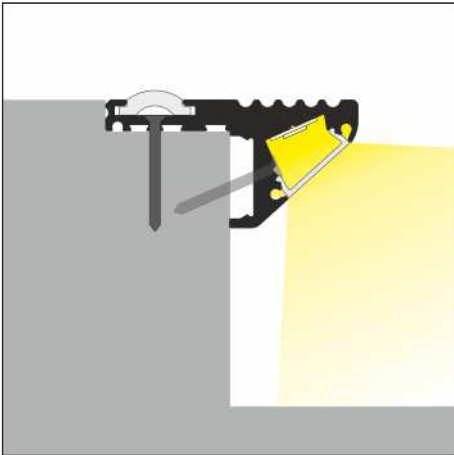

max 10 mm



special application



INDEX = 1 pc, length 2000 mm
package = 10 pcs

● anodized
32080020

● black anodized
32080021

Available lengths: 1000 mm, 2000 mm, 3000 mm, 4000 mm.
The standard profile length tolerance is +2 mm.
For more details please see page 1.08.



COVERS

C click cover
 colours: transparent, opal
 material: PMMA

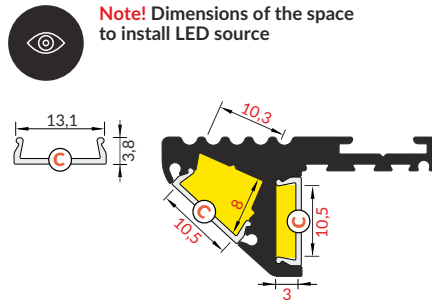

INDEX = 1 pc, length 2000 mm
 package = 10 pcs

C transparent
 76330000

C opal
 76330038

The standard cover length tolerance is +20 mm.
 For more details please see page 1.08.

ENDINGS

STEP10 ending
 colours: silver, black
 material: steel

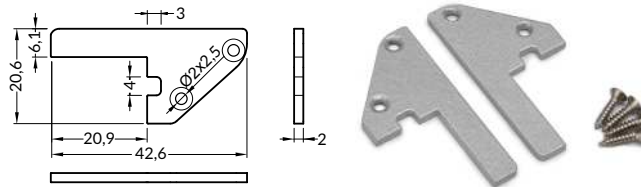

INDEX = 1 set = 2 pcs

silver
 32100022

black
 32100002

COVER

STEP10 LED cover
 colours: anodized, black
 material: aluminium

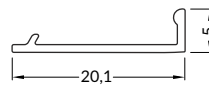

INDEX = 1 pc, length 2000 mm
 package = 10 pcs

anodized
 32120020
 black anodized
 32120021

Available lengths: 1000 mm, 2000 mm, 3000 mm, 4000 mm.
 The standard profile length tolerance is +2 mm.
 For more details please see page 1.08.

INSERT

STEP10 anti slip insert
 colours: transparent, black



INDEX = 1 pc, length 2000 mm
 package = 10 pcs

transparent
 32150000
 black
 32150002

TWO MOUNTING OPTIONS

1. Illuminating a step with anti slip insert applied.



2. Illuminating a step and edge highlighting.



AMBI12 C

ALUMINIUM LED PROFILE FOR CREATING LUMINAIRES

- decorative illumination
- maximum LED strip width: 12 mm



SIMILAR IN THE OFFER

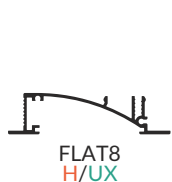



C click cover
C

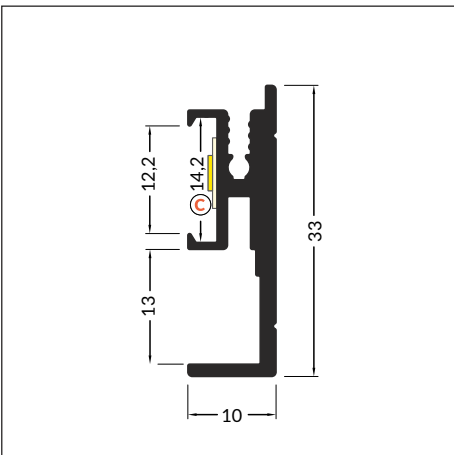
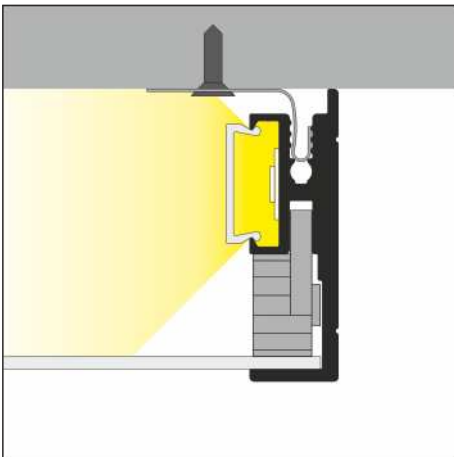
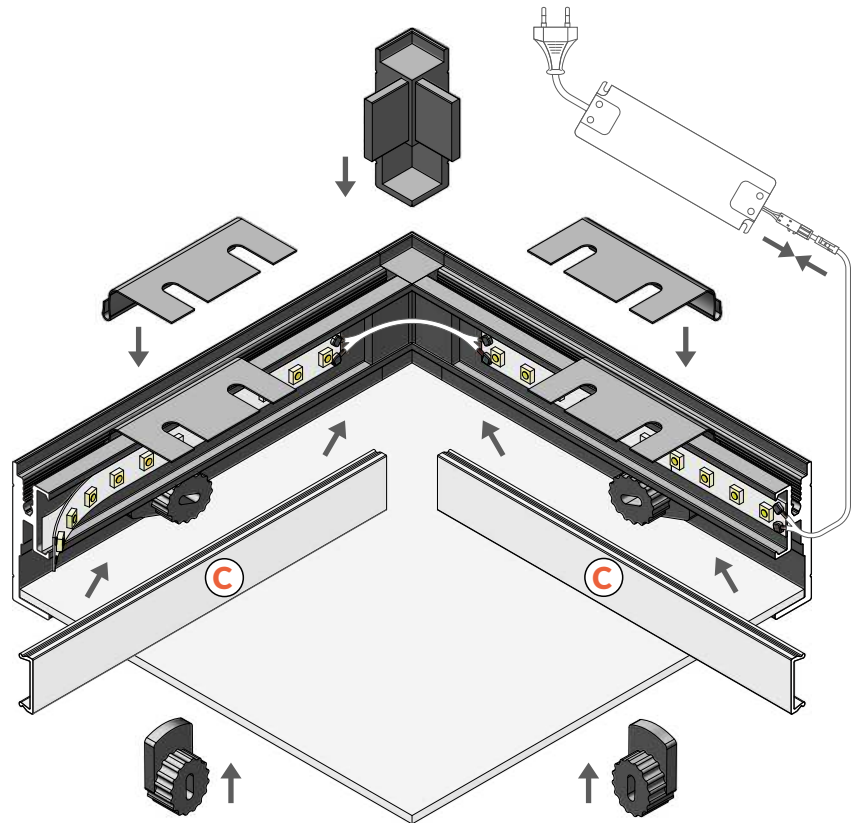

INDEX = 1 pc,
package = 10 pcs .

○	white painted	
	110 mm	B3520001
	575 mm	B3540001
	1000 mm	B3500001
	2000 mm	B3510001
●	anodized	
	110 mm	B3520020
	575 mm	B3540020
	1000 mm	B3500020
	2000 mm	B3510020

Available lengths: 110 mm, 575 mm, 1000 mm, 2000 mm, 3000 mm, 4000 mm.
The standard profile length tolerance is +2 mm.
For more details please see page 1.08.



max 12 mm



special application



COVERS

C click cover
colours: transparent, opal
material: PMMA

AMBI12 cover
colour: opal
material: PET

cover 590x590x1,5
colour: opal
material: PS



Note! Dimensions of the space to install LED source

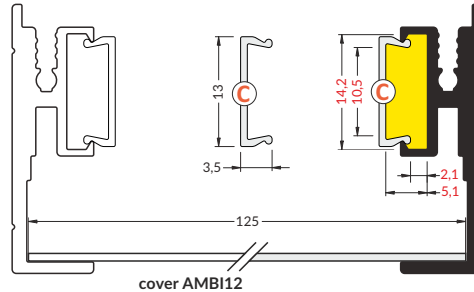

INDEX = 1 pc
package = 10 pcs .

C transparent

1000 mm 76320000
2000 mm 76330000

C opal

1000 mm 76320038
2000 mm 76330038

INDEX = 1 pc

opal cover

1010 x 125 mm B3500038
2010 x 125 mm B3501038
590 x 590 mm B3503038

The standard cover length tolerance is +20 mm.
For more details please see page 1.08.

CONNECTOR

AMBI12 connector 90 deg
colour: white, grey, silver
material: ABS

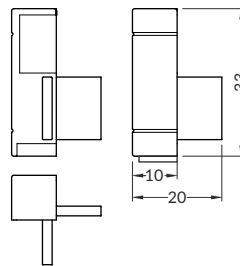

INDEX = 1 set = 4 pcs

○ white B3990001

● grey B3990022

● silver B3990040

CLAMP

AMBI12 clamp
colours: white
material: ABS

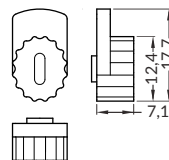

INDEX = 1 set = 4 pcs

○ white B3970001

MOUNTING

AMBI12 flexible holder
colour: inox
material: stainless steel

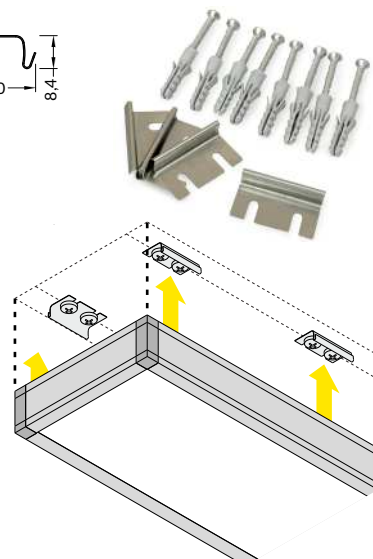
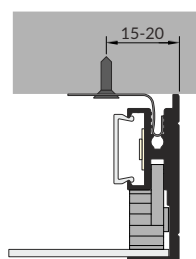
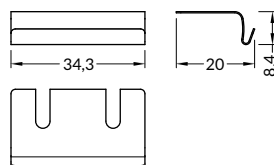

INDEX = 1 set = 4 pcs
= 4 szt.

● inox B3960019



LED profile AMBI12 and dedicated diffusers allows to create decorative luminaires in different dimensions. Depending on the LED strip used, different light effects can be achieved - smooth, edge or more intensive with even lighting surface, that could be strengthen when mounted on a white surface.

ARC12 CD/U5

FLEXIBLE ALUMINIUM LED PROFILE

- flexible aluminium profile - possibility of bending in two directions
- the profile keeps shaped bend
- minimal bending radius: 50 cm
- decorative and illuminating purpose of the profile
- possibility of using two diffusers – better light dispersion
- possible outside installation (with D cover and waterproof LED strip used)
- maximum LED strip width: 12 mm



SIMILAR IN THE OFFER

SLIM8
A/Z

SMART10
A/Z

BEGTON12
J/S

UNI12
BCD/U



C click cover

D click cover

U5¹ cone U5 mounting plate

U5² side U5 mounting plate

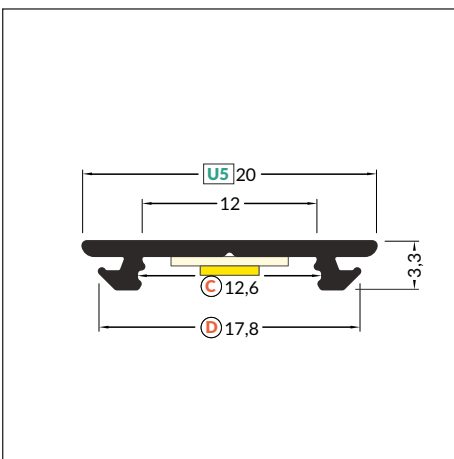
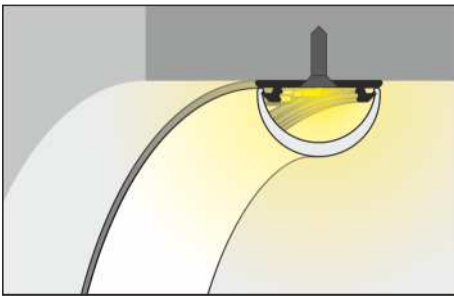
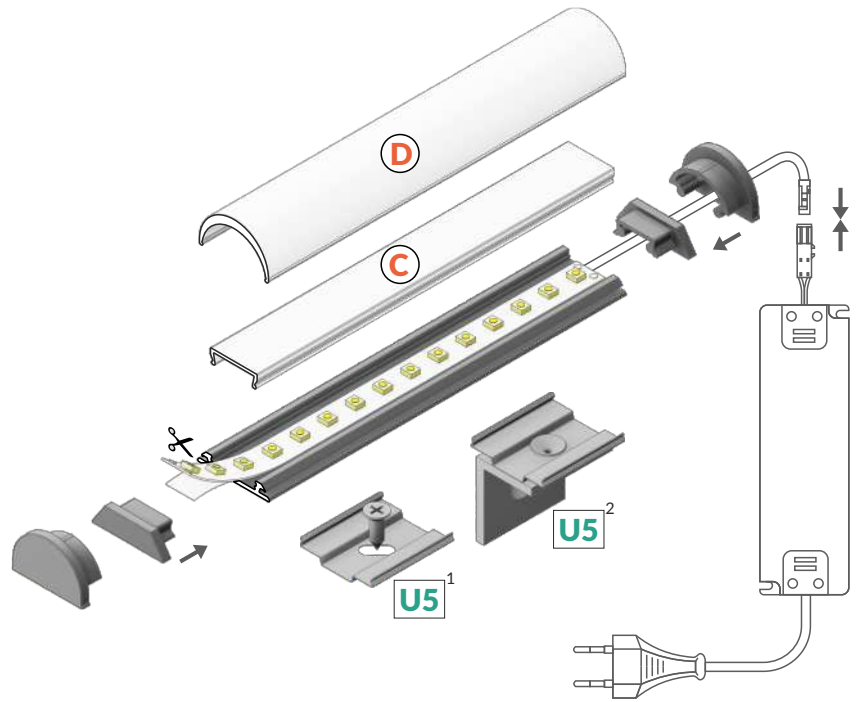



 max 12 mm

 special application



INDEX = 1 pc, length 2000 mm
package = 10 pcs

 white painted
B2010001

 anodized
B2010020

 black painted
B2010002

 raw aluminium
B2010000

Available lengths: 1000 mm, 2000 mm, 3000 mm, 4000 mm.
The standard profile length tolerance is +2 mm.
For more details please see page 1.08.

ACCESSORIES

COVERS

C click cover
colours: transparent, opal
material: PMMA

D click cover
colour: opal
material: PMMA



Note! Dimensions of the space to install LED source

Maximum LED strip width while using C cover: 10 mm

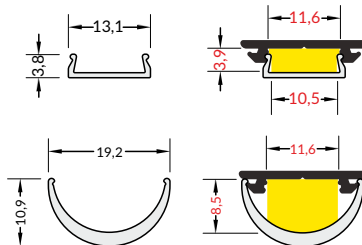

INDEX = 1 pc, length 2000 mm
package = 10 pcs

C transparent
76330000

C opal
76330038

D opal
A1140038

The standard cover length tolerance is +20 mm.
For more details please see page 1.08.

ENDINGS

ARC12 ending
colours: white, silver, black, grey
material: ABS

ARC12 D ending
colours: white, silver, black, grey
material: ABS





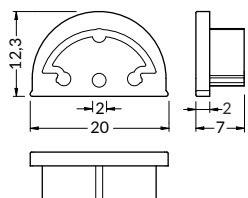
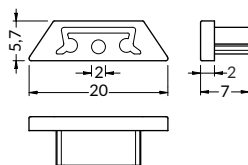

Ending with marked space to bore the holes.







INDEX = 1 set, package = 10 sets = 20 pcs

ARC12 ending

-  white B2960001
-  silver B2960040
-  black B2960002
-  grey B2960022

ARC12 D ending

-  white B2980001
-  silver B2980040
-  black B2980002
-  grey B2980022

MOUNTINGS

cone **U5** mounting plate
colour: inox
material: stainless steel

side **U5** mounting plate
colours: white, silver, black
material: stainless steel, aluminium

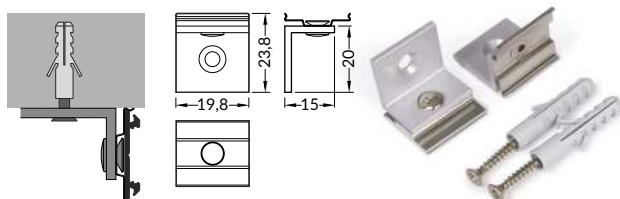
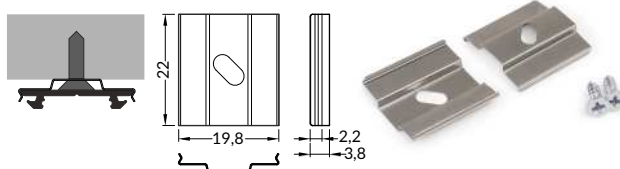



INDEX = 1 set
package = 10 sets = 20 pcs

cone **U5** mounting plate

-  inox inox B2940019

side **U5** mounting plate

-  white B2920001
-  silver B2920022
-  black B2920002

ACCESSORIES



SLING

SELV sling 50 V 1500
 colour: white, silver, black

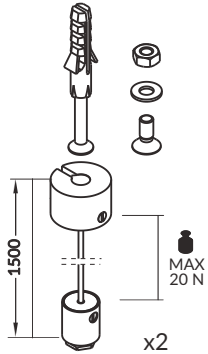

INDEX = 1 set

SELV sling 50 V 1500

- white 67120001
- silver 67120022
- black 67120002



FIX12 / FIX16



THE SIMPLEST INSTALLATION OF A LED STRIP

- function of radiator
- improves LED strip's adhesion
- minimal height of the profile
- budget profile, to be used without a cover
- maximum width of LED strip: 12 mm (FIX12) and 16 mm (FIX16)
- it can also function as a mounting profile:
FIX12 for profiles with X socket
FIX16 for profiles with T socket



SIMILAR IN THE OFFER



SLIM8
A/Z



SMART10
A/Z



SURFACE10
BC/UX



BEGTON12
J/S



ARC12
CD/R



SURFACE14
EF/TY

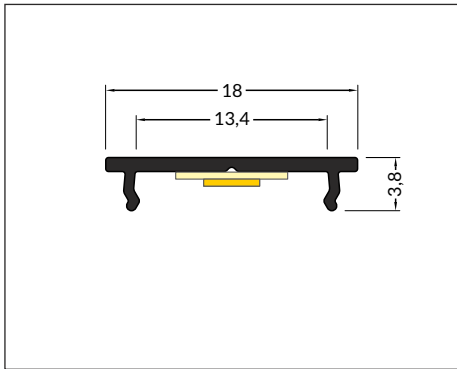
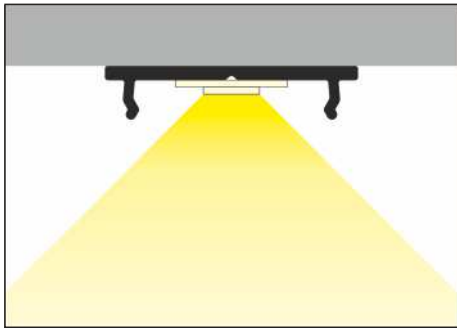

max 12 mm



special application



mounting with screws
or adhesive tape



INDEX = 1 pc, length 2000 mm
package = 10 pcs

anodized
87030020



raw aluminium
87030000

Available lengths: 1000 mm, 2000 mm, 3000 mm, 4000 mm.
The standard profile length tolerance is +2 mm.
For more details please see page 1.08.

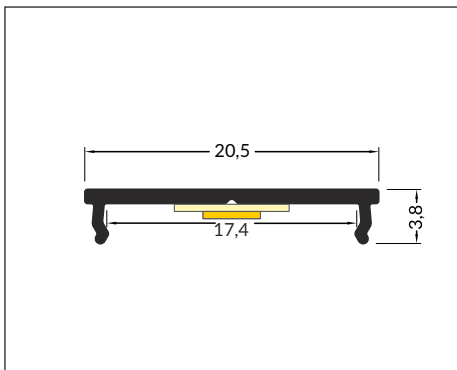
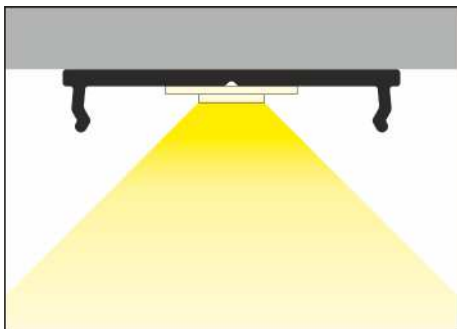

max 16 mm



special application



mounting with screws
or adhesive tape



INDEX = 1 pc, length 2000 mm
package = 10 pcs

white painted
C6020001



anodized
C6020020



black anodized
C6020021



raw aluminium
C6020000

Available lengths: 1000 mm, 2000 mm, 3000 mm, 4000 mm.
The standard profile length tolerance is +2 mm.
For more details please see page 1.08.

OUTSTAIRS12 BC

BRASS PROFILE TO ILLUMINATE THE EDGE OF A STAIR STEPS

- high resistance to weather conditions
- in high humidity conditions we recommend using IP65 LED strip
- maximum LED strip width: 12 mm



SIMILAR IN THE OFFER



STEP10
C



FLOOR12
K/U



B slide cover

C click cover

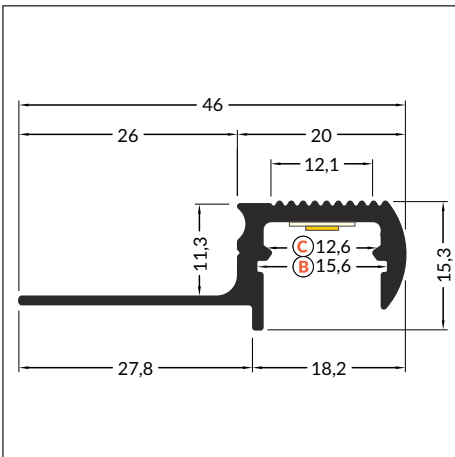
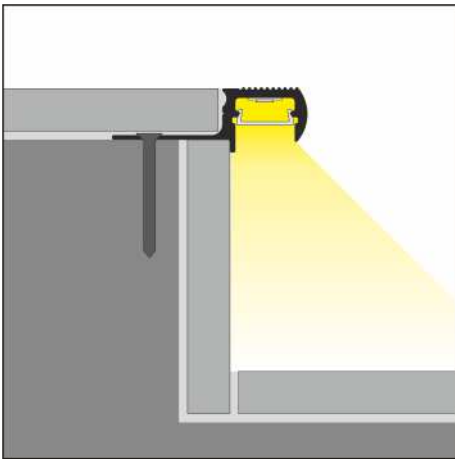
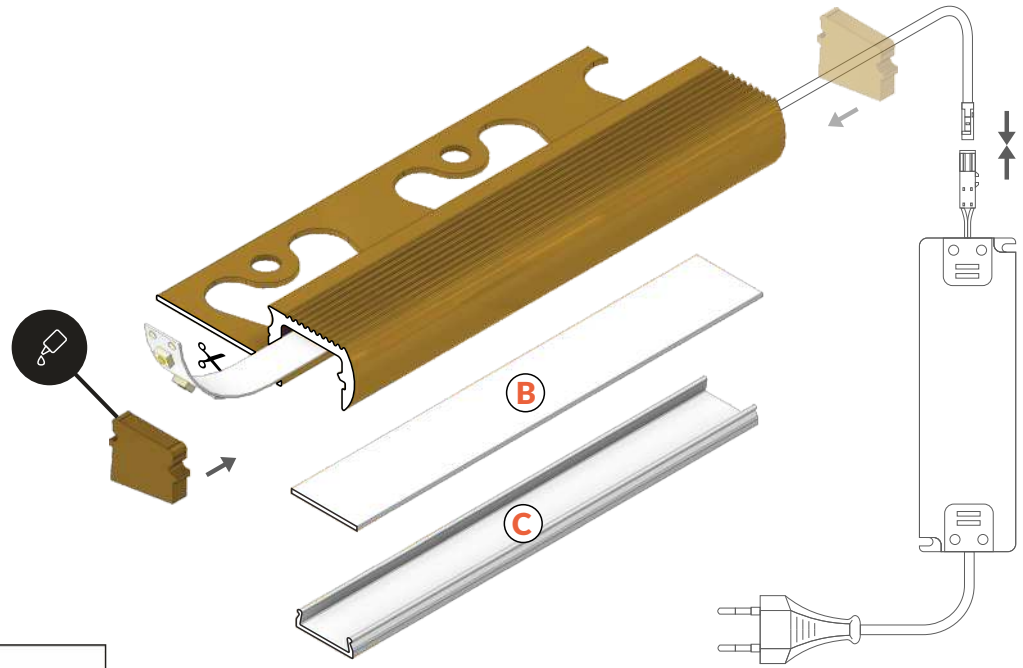

INDEX = 1 pc, length 1600 mm .,



brass
B9020005s

Available lengths: 1100 mm, 1600 mm.
The standard profile length tolerance is +2 mm.
For more details please see page 1.08.

max 12 mm

special application

ACCESSORIES



COVERS

B slide cover
 colours: transparent, frosted, opal
 material: PC, PP, PP



Note! Dimensions of the space to install LED source

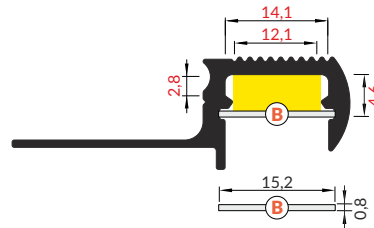

C click cover
 colours: transparent, opal
 material: PMMA

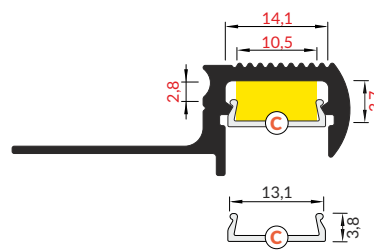

INDEX = 1 pc, length 2000 mm
 package = 10 pcs



B transparent
 76250016

B frosted
 76250039

B opal
 76250038

C transparent
 76330000

C opal
 76330038

The standard cover length tolerance is +20 mm.
 For more details please see page 1.08.

ENDINGS

OUTSTAIRS12 ending
 colour: brass
 material: brass

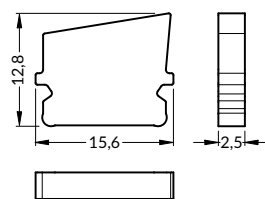

Endings mounted on assembly adhesive

INDEX = 1 set

 brass
 B9990005



WALLE12 BCD

WALL-MOUNTED PROFILE

- mounted directly to a wall or ceiling
- 6 types of matching covers
- possibility of outdoor using (with D cover and waterproof LED strip)
- maximum LED strip width: 12 mm



SIMILAR IN THE OFFER

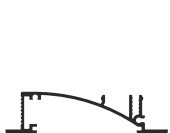

FLAT8
H/UX



BACK10
A/UX



AMBI12
C



FRAME14
BC/Q



- B** slide cover
- C** click cover
C
- D** click cover
D

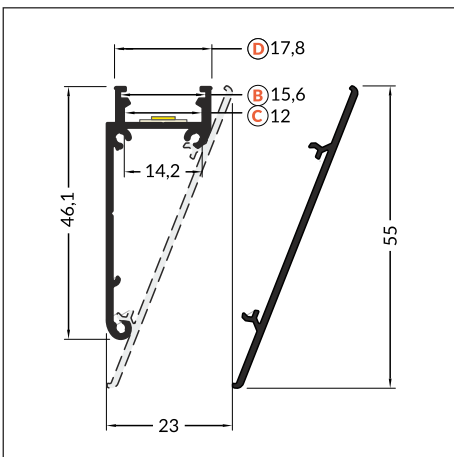
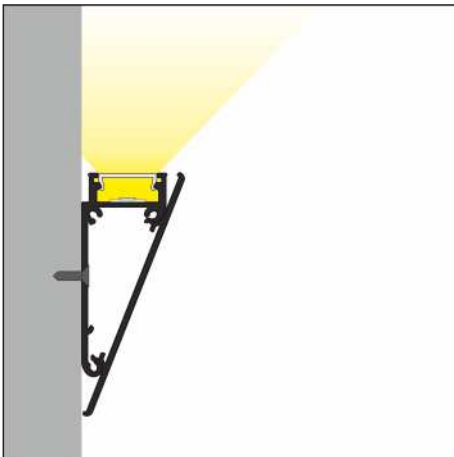
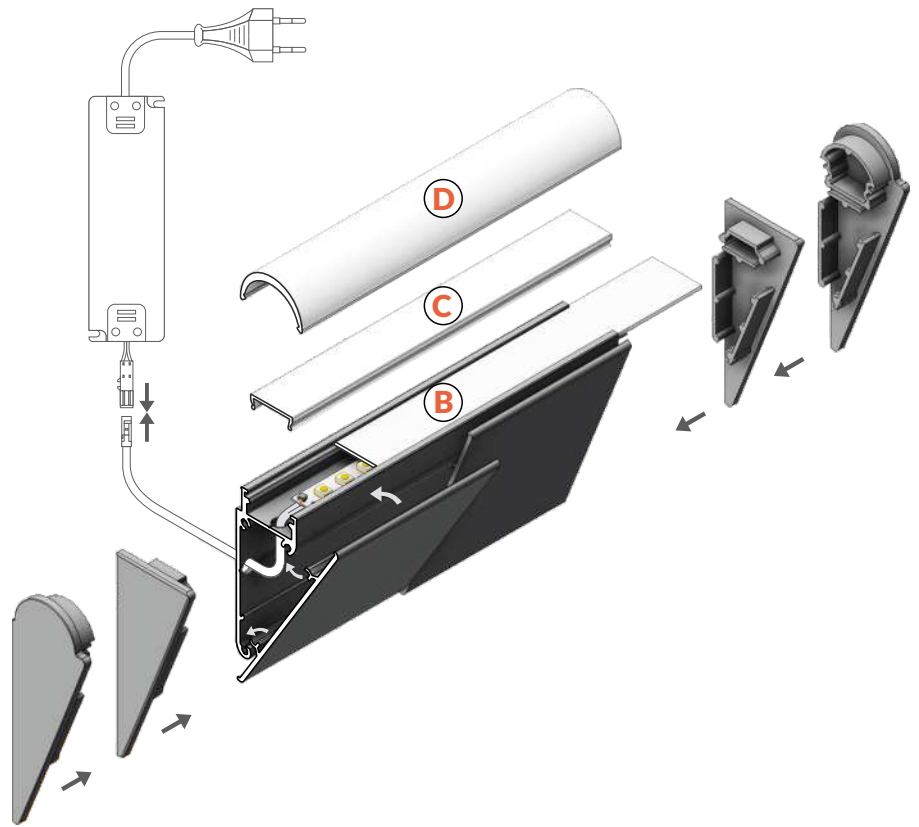

 max 12 mm

 special application

INDEX = 1 pc, length 2000 mm
package = 10 pcs



 white painted
B8060001



 anodized
B8020020



 raw aluminium
C6020000

Available lengths: 1000 mm, 2000 mm, 3000 mm, 4000 mm.
The standard profile length tolerance is +2 mm.
For more details please see page 1.08.

ACCESSORIES



COVERS

B slide cover
colours: transparent, frosted, opal
material: PC, PP, PP



Note!
Dimensions of the space
to install LED source

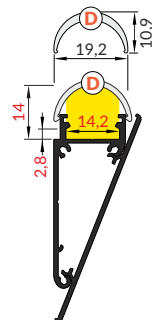
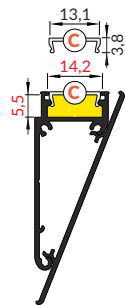
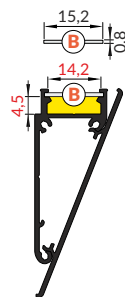

C click cover
colours: transparent, opal
material: PMMA

D click cover
colour: opal
material: PMMA

INDEX = 1 pc, length 2000 mm
package = 10 pcs

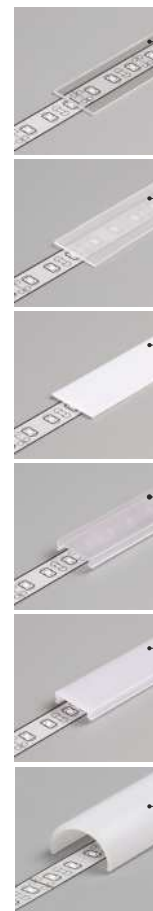

B transparent
76250016

B frosted
76250039

B opal
76250038

C transparent
76330000

C opal
76330038

D opal
A1140038

The standard cover length tolerance is +20 mm.
For more details please see page 1.08.

ENDINGS

WALLE12 ending
colours: white, silver, grey
material: ABS

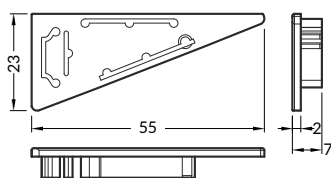

INDEX = 1 set
package = 10 sets = 20 pcs

WALLE12 ending

○ white B8900001

● silver B8900040

● grey B8900022

WALLE12 D ending
colours: white, silver, grey
material: ABS

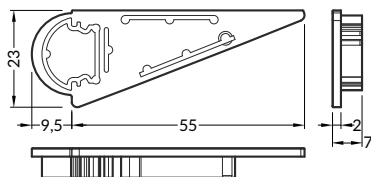

WALLE12 D ending

○ white B8890001

● silver B8890040

● grey B8890022

ACCESSORIES



COVER

WALLE12 cover
 colours: white, anodized
 material: aluminium



INDEX = 1 pc, length 2000 mm
 package = 10 pcs

- white painted B8080001
- anodized B8040020

Available lengths: 1000 mm, 2000 mm, 3000 mm, 4000 mm.
 The standard profile length tolerance is +2 mm. For more details please see page 1.08.

CONNECTORS

WALLE12 connector 180 deg
 colour: inox
 material: stainless steel

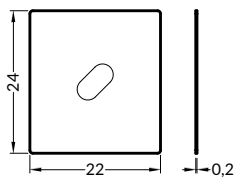

INDEX = 1 set

- inox
 inox
 B8950019

WALLE12 connector 90 deg
 colours: white, anodized
 material: aluminium

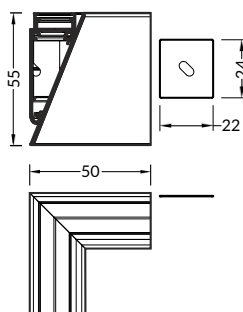

- white painted
 B8910001
- anodized
 B8910020



FRAME14 BC/Q

ALUMINIUM LED PROFILE FOR PLASTERBOARD

- dedicated for plasterboards - decorative construction finish
- continuous line of light (when using LED strip 120 P/m and opal cover)
- multiple arrangements through a variety of connectors
- maximum LED strip width: 14 mm



SIMILAR IN THE OFFER





- B** slide cover
- C** click cover
- Q¹** 90 deg bent connector
- Q²** Q connector 180 deg
- Q³** Q connector 135 deg
- Q⁴** Q connector 90 deg

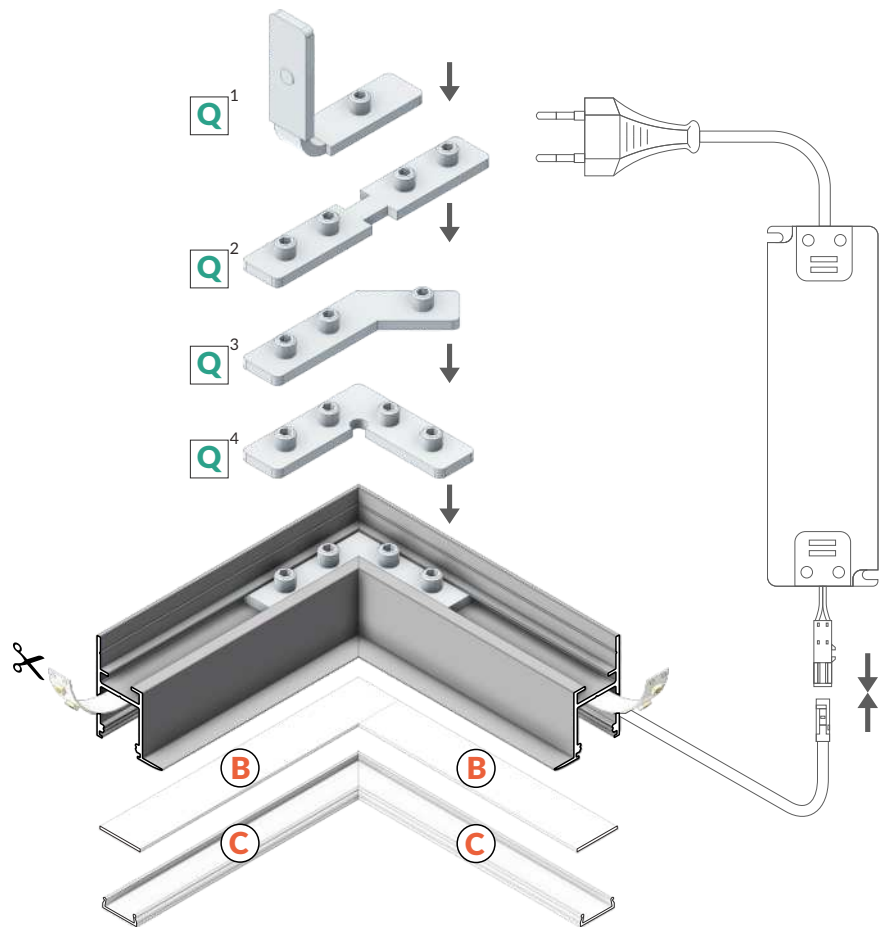
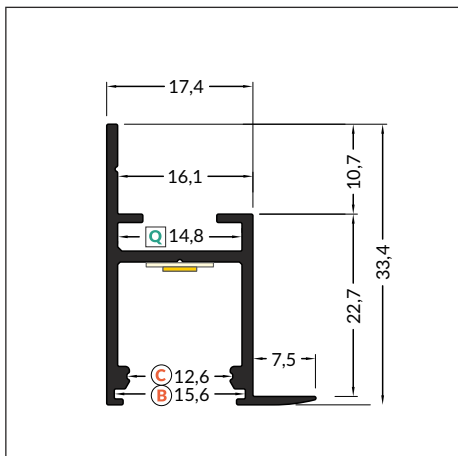
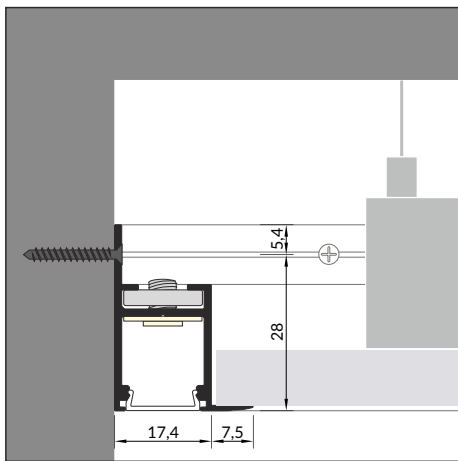
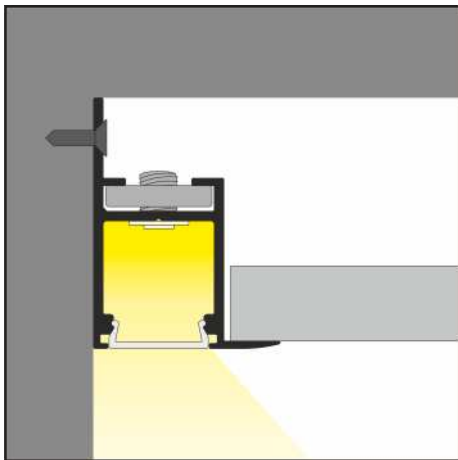

INDEX = 1 pc, length 2000 mm
package = 10 pcs

○ white painted
C3020001

● anodized
C3020020

● raw aluminium
C3020000

Please note! The profile isn't a construction profile.

● max 14 mm

● special application



Available lengths: 1000 mm, 2000 mm, 3000 mm, 4000 mm.
The standard profile length tolerance is +2 mm.
For more details please see page 1.08.

ACCESSORIES



COVERS

B slide cover
 colours: transparent, frosted, opal
 material: PC, PP, PP

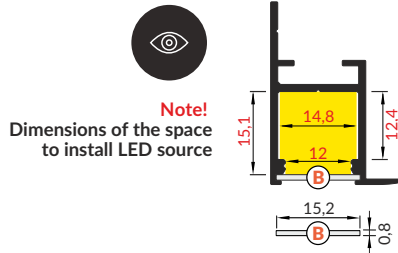

INDEX = 1 pc, length 2000 mm
 package = 10 pcs

B transparent
 76250016



B frosted
 76250039

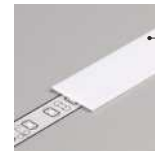

B opal
 76250038

C click cover
 colours: transparent, opal
 material: PMMA

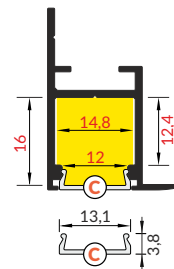

C transparent
 76330000



C opal
 76330038

The standard cover length tolerance is +20 mm.
 For more details please see page 1.08.

CONNECTORS

Q 180 deg / 135 deg / 90 deg connector
 material: zinc coated

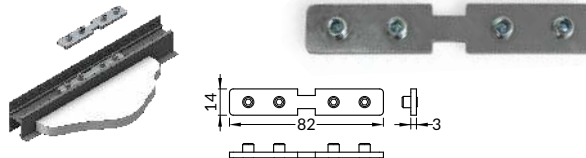

INDEX = 1 pc

Q 180 deg connector
 C3990030

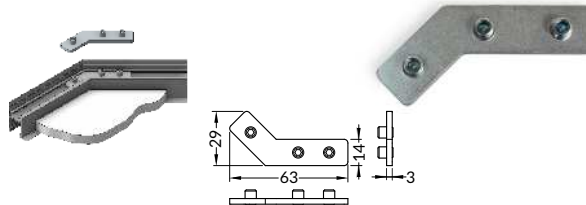

Q 135 deg connector
 C3980030

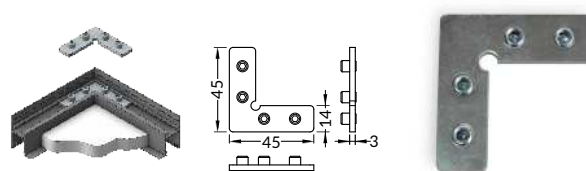

Q 90 deg connector
 C3970030

Q 90 deg bent connector
 material: zinc coated

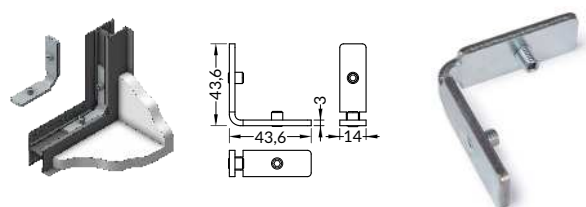

Q 90 deg bent connector
 C3960030



OVAL20 BC

A DOUBLE-FUNCTION BAR FOR WARDROBES

- a bar for hanging garments and illuminating the wardrobe
- 3 mounting options: side-to-side, as an extension arm from a side, as an extension arm from the top
- two LED strip installation depths to choose from
- maximum LED strip width: 20 mm

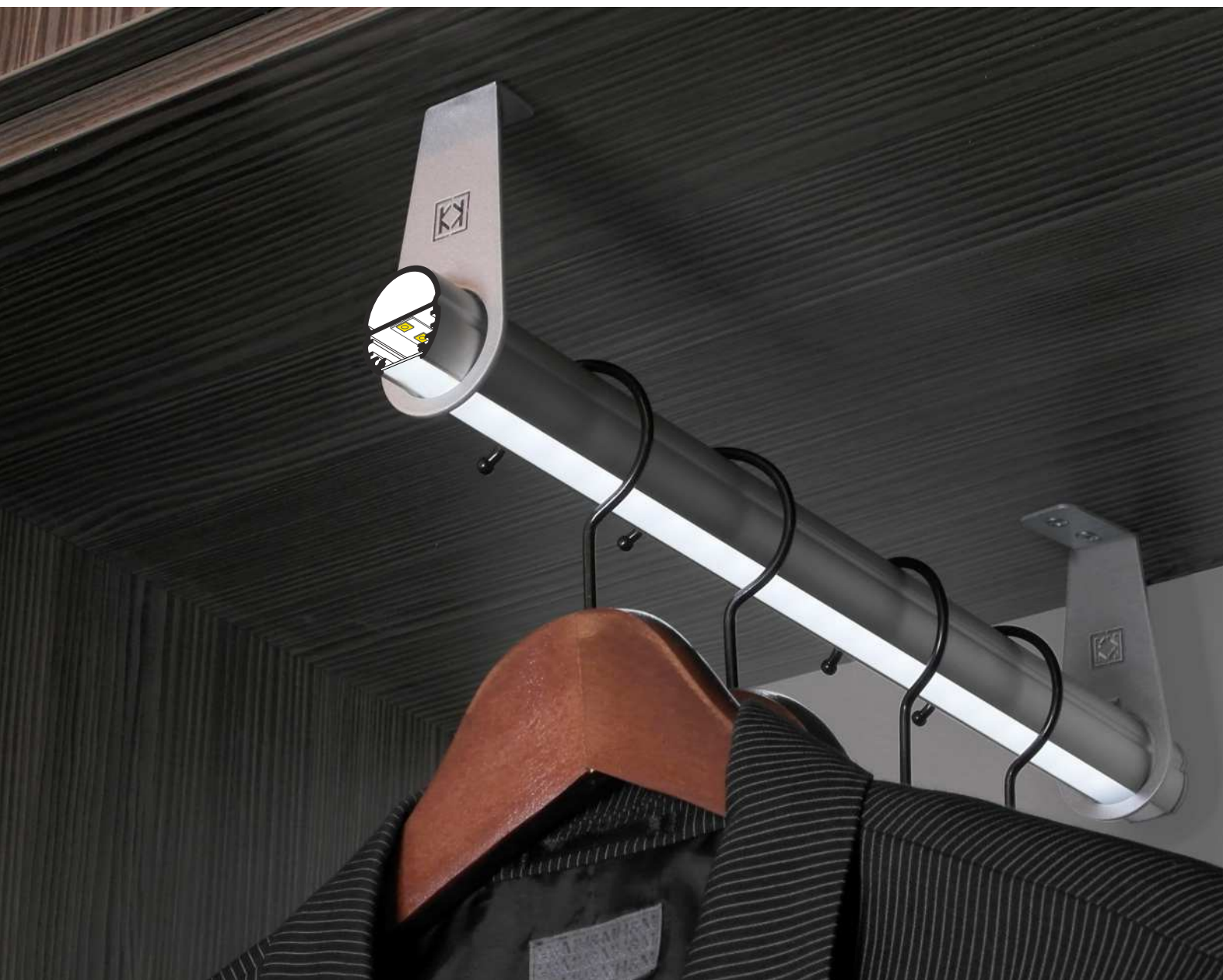

SIMILAR IN THE OFFER



B B slide cover

C C click cover
C

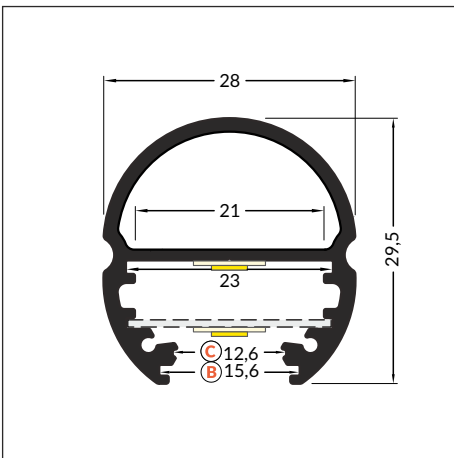
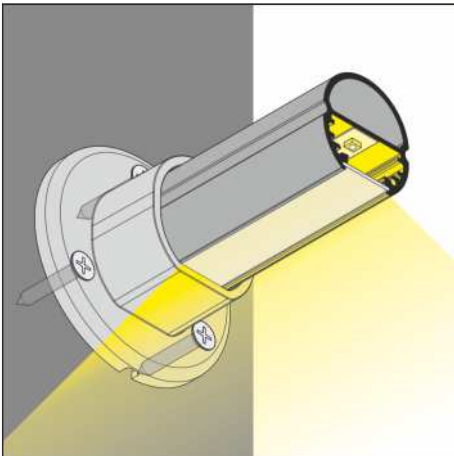
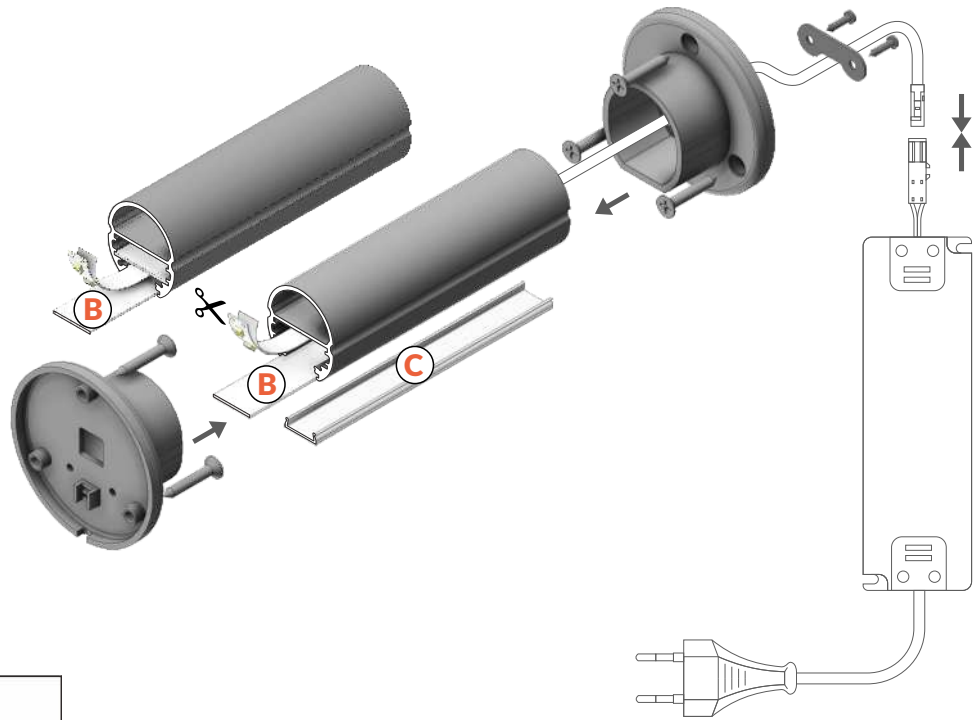

INDEX = 1 pc, length 2000 mm
package = 10 pcs

● anodized
92030020



Available lengths: 1000 mm, 2000 mm, 3000 mm, 4000 mm.
The standard profile length tolerance is +2 mm.
For more details please see page 1.08.

 max 20 mm

 special application

ACCESSORIES



COVERS

B slide cover
 colours: transparent, frosted, opal
 material: PC, PP, PP



Note! Dimensions of the space to install LED source

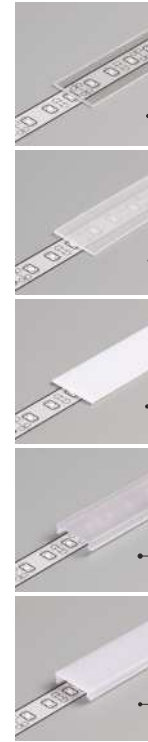
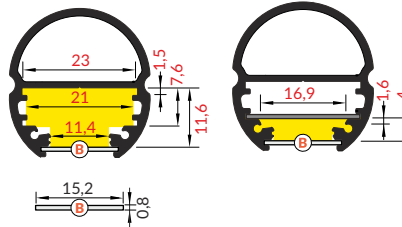

INDEX = 1 pc, length 2000 mm
 package = 10 pcs

B transparent
 76250016

B frosted
 76250039

B opal
 76250038

C click cover
 colours: transparent, opal
 material: PMMA

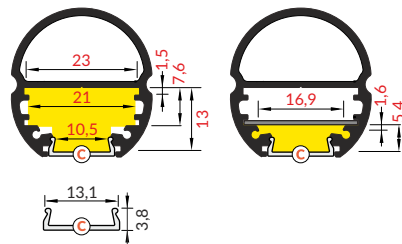

C transparent
 76330000

C opal
 76330038

The standard cover length tolerance is +20 mm.
 For more details please see page 1.08.

MOUNTINGS

OVAL20 side holder
 colours: silver, grey
 material: ABS

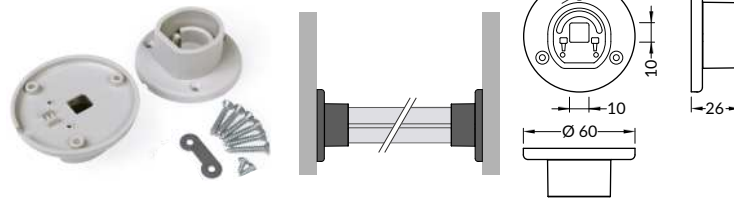

INDEX = 1 set

OVAL20 side holder

- silver 92040040
- grey 92040022

OVAL20 single extension arm
 colour: silver
 material: ABS, steel, aluminium

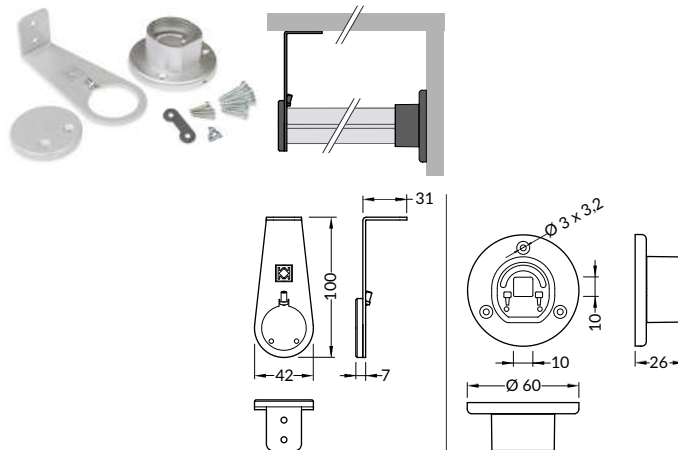

single extension arm

- silver 92980040

OVAL20 double extension arm
 colour: silver
 material: ABS, steel, aluminium

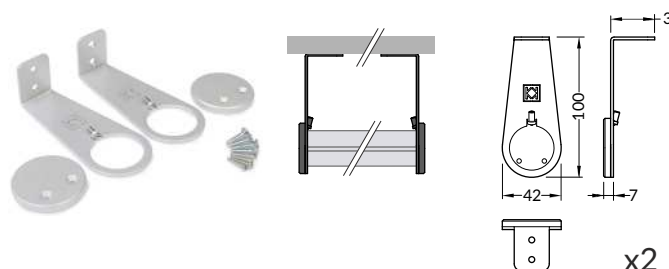

double extension arm

- silver 92990040

ACCESSORIES



MOUNTINGS

OVAL20 simple holder
material: zinc coated steel



INDEX = 1 set

OVAL20 simple holder

○ zinc coated
92070030

LED MOUNTING

OVAL20 LED mounting
material: aluminium

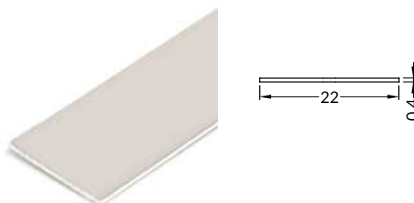

INDEX for 2000 mm length

○ raw aluminium
92100000



TWIN8

A TWO-WAY EDGE PROFILE FOR GLASS SHELVES

- decorative illumination
- mounted on the glass or shelf rear edge
- 2 lighting directions: up and down
- illuminating the rear side of a display case
- additionally illumination of the glass edge with the TWIN8 PLUS profile
- fits the 8 mm thick glass panel
- when using on a thinner glass, consider additional adhesive tape
- note: the profile is not a construction element
- maximum LED strip width: 8 mm

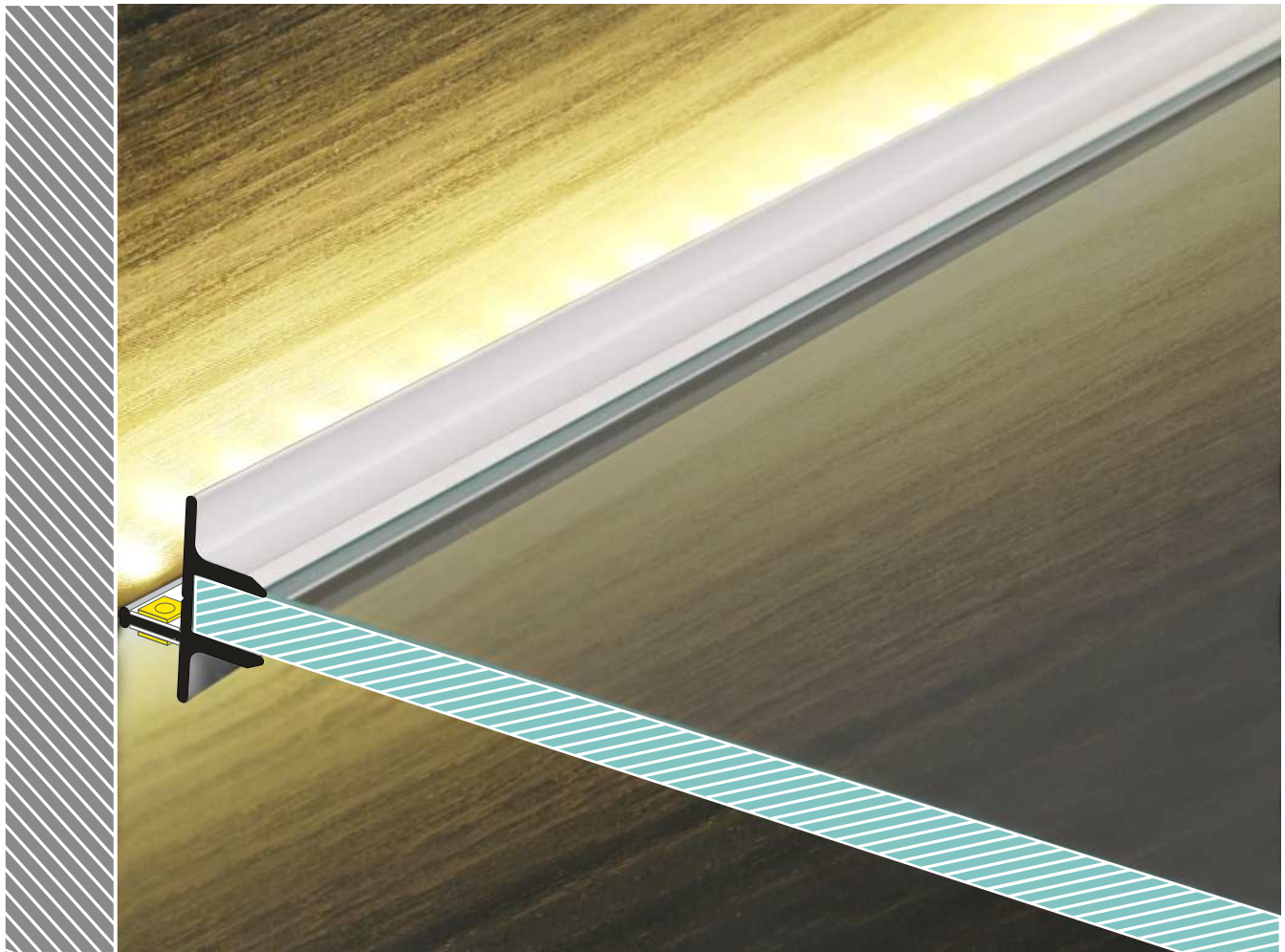

SIMILAR IN THE OFFER



BACK10
A/UX



EDGE10
BC



MIKRO10



MIKRO-LINE12



CABI12
E

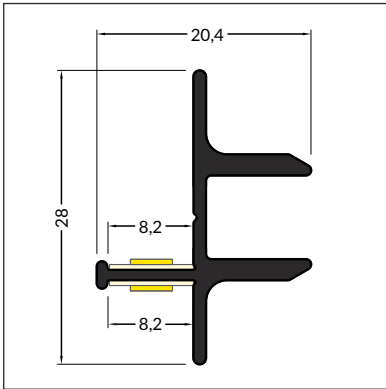

max 8 mm



glass application

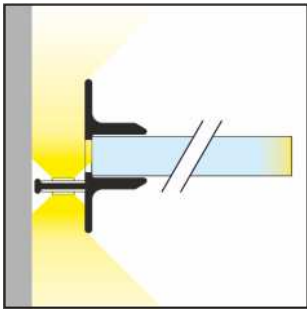
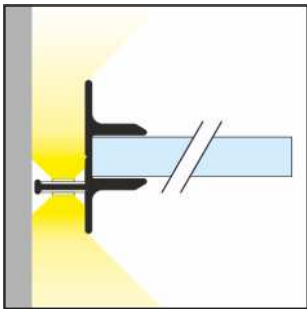
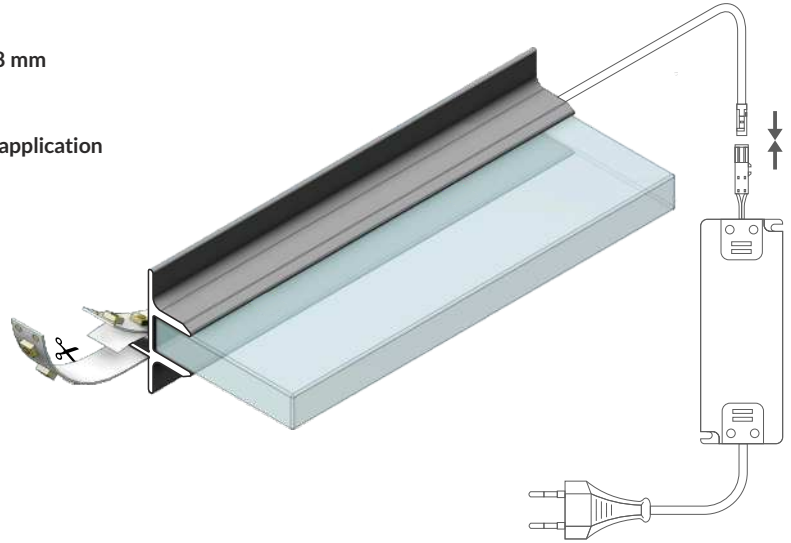

INDEX = 1 pc, length 2000 mm
package = 10 pcs

TWIN8
raw aluminium
82150000

TWIN8 PLUS
raw aluminium
82160000

Available lengths: 1000 mm, 2000 mm,
3000 mm, 4000 mm. The standard profile
length tolerance is +2 mm.
For more details please see page 1.08.

THERMAL TAPE

thermal tape 45 x 10 mm
self adhesive, double-sided

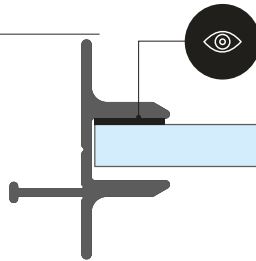

INDEX = 1 pc

53820000



MIKRO10

A SMALL EDGE PROFILE FOR GLASS PANELS

- to illuminate the edge or engraving on the glass panel surface
- to be used for furniture (display cases) or advertising
- discreet form
- fits the 6 mm thick glass panel
- note: the profile is not a construction element
- maximum LED strip width: 10 mm

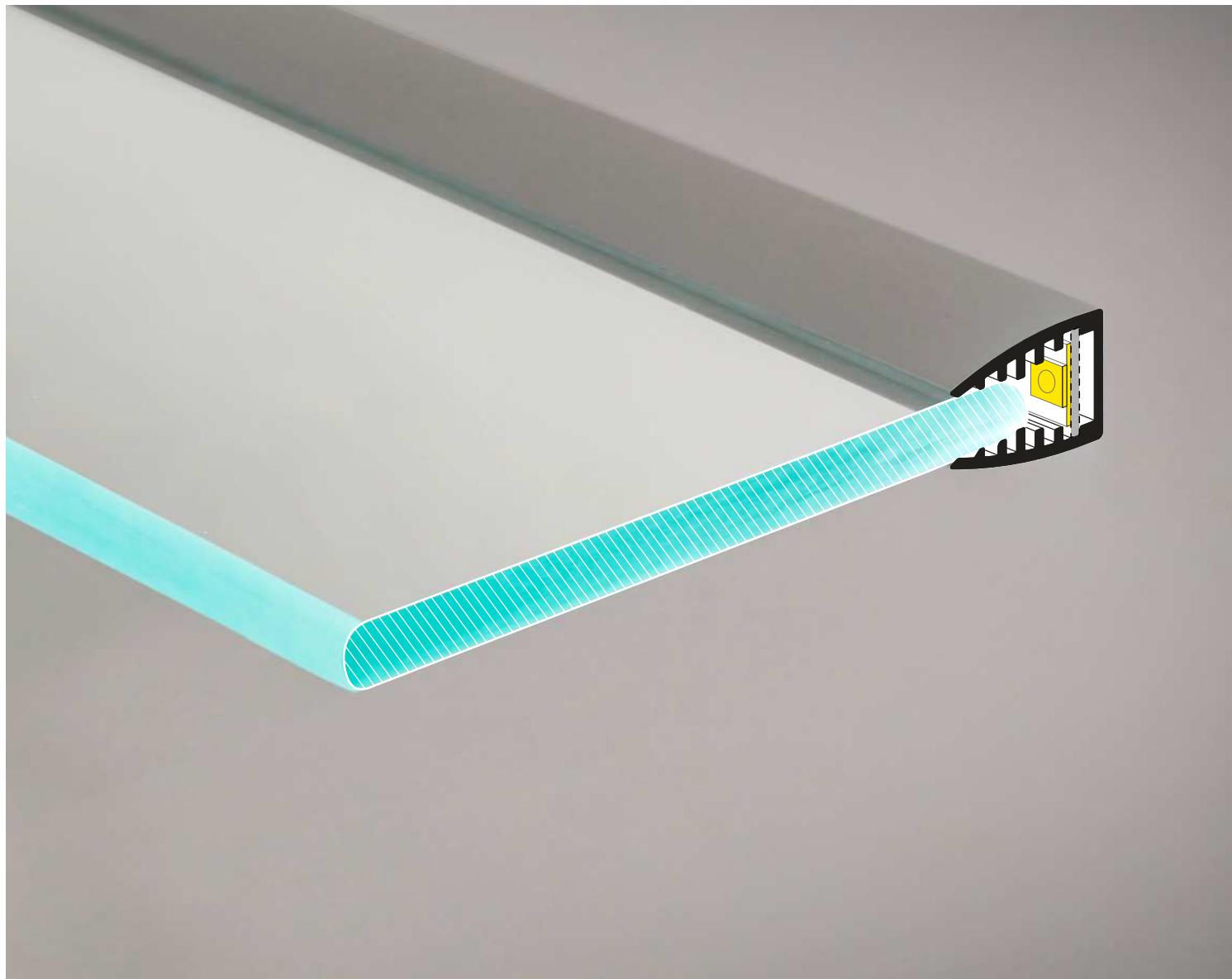

SIMILAR IN THE OFFER



TWIN8



EDGE10
BC



MIKRO-LINE12



CABI12
E

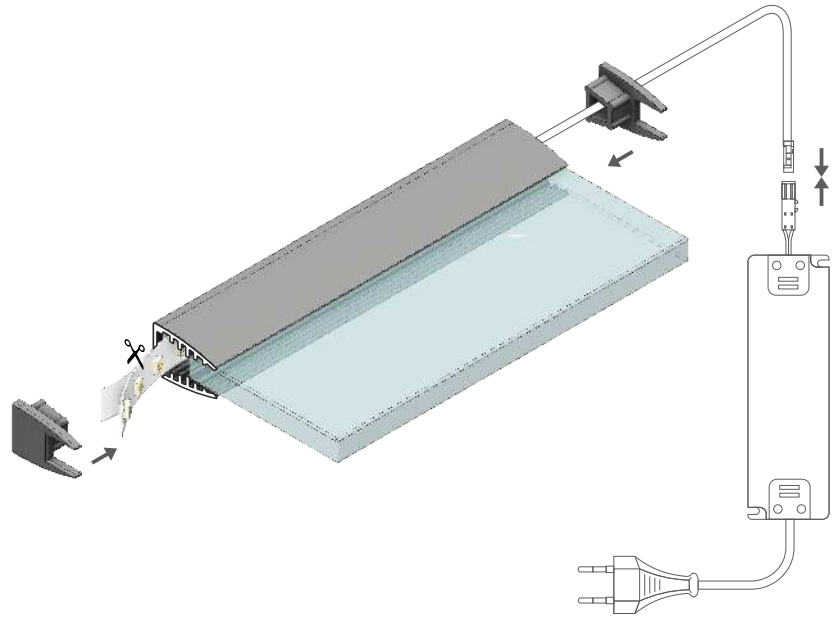
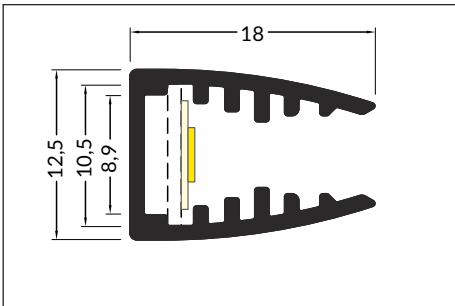
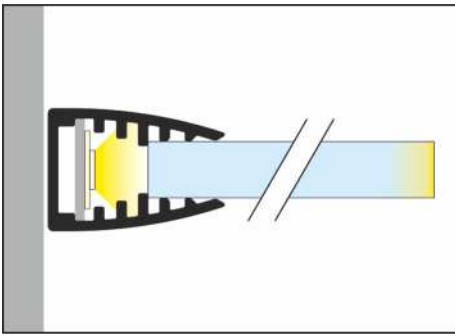

max 10 mm



glass application



INDEX = 1 pc, length 2000 mm
package = 10 pcs



anodized

68540020

Available lengths: 1000 mm, 2000 mm, 3000 mm, 4000 mm. The standard profile length tolerance is +2 mm. For more details please see page 1.08.

ENDINGS

MIKRO10 ending
colours: silver, grey, transparent
material: ABS, ABS, PC

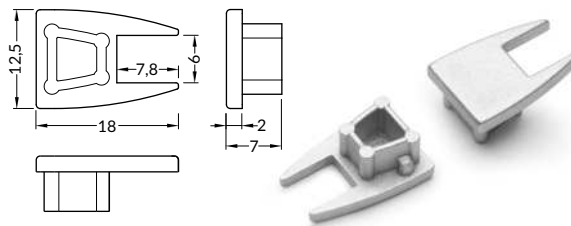

INDEX = 1 set
package of 10 sets = 20 pcs .



silver

68550040



grey

68550022



transparent

68550000

LED MOUNTING

MIKRO10 LED mounting
material: HIPS

INDEX = 1 pc, length 2000 mm
package = 10 pcs

68640000

Available lengths 1000 mm, 2000 mm

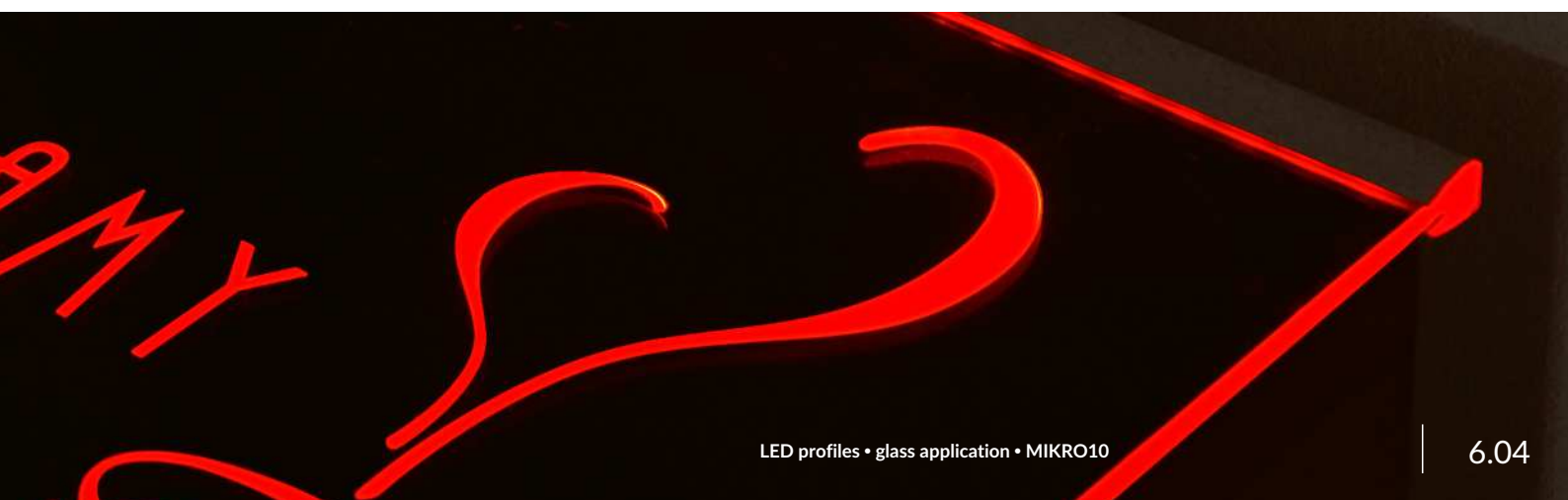

EDGE10 BC

FINISHING EDGES AND LIGHTING OF DISPLAY WINDOWS

- the product for finishing and strengthening display window edges to a thickness up to 8 mm
- suitable for decorative 'framing' of the display window
- light is emitted at an angle - it does not cause glare
- top or bottom illumination
- easy installation - a double-sided tape not visible to customers
- when using on a thinner glass, consider additional wedging or adhesive tape
- maximum LED strip width: 10 mm



SIMILAR IN THE OFFER



TWIN8



MIKRO10



MIKRO-LINE12



FRAME14
BC/Q



CABI12
E



B slide cover

C click cover

C lens cover

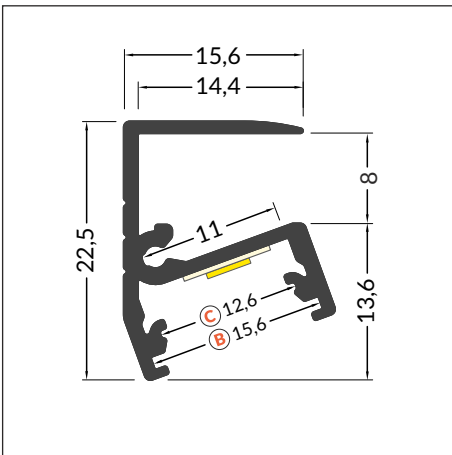
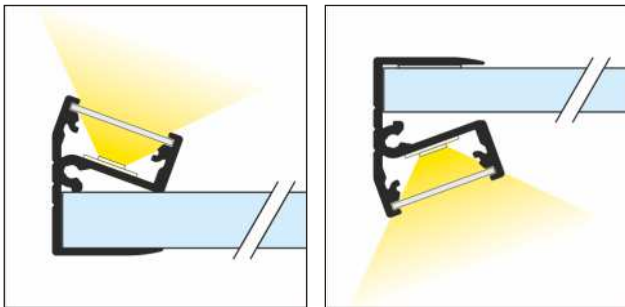
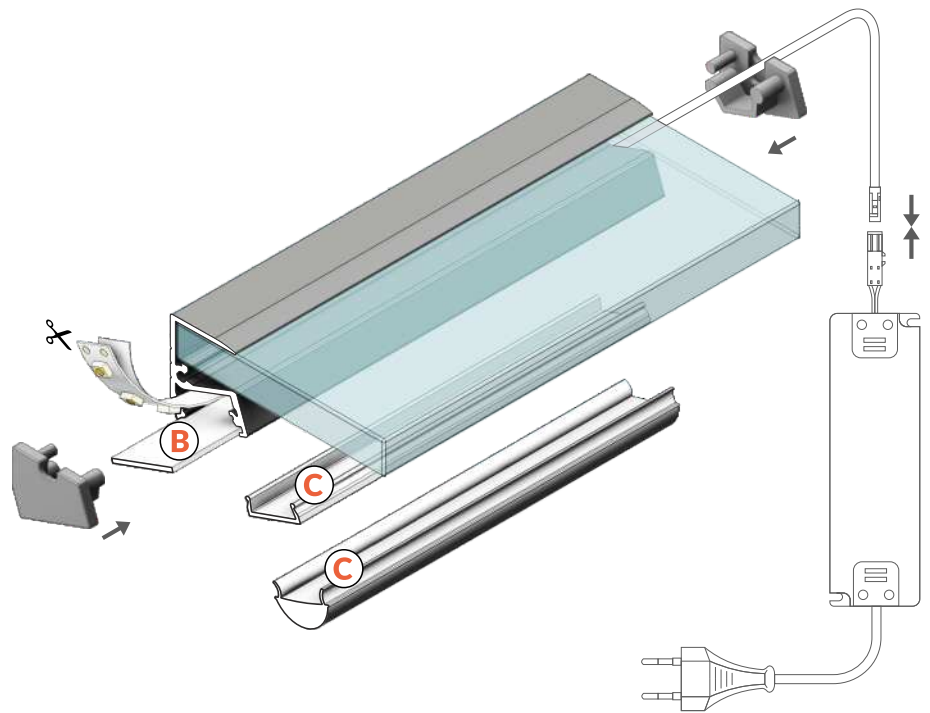

max 10 mm



glass application



INDEX = 1 pc, length 2000 mm
package = 10 pcs

○ white painted
A9020001

● anodized
A9020020

● black anodized
A9020021

○ raw aluminium
A9020000

Available lengths: 1000 mm, 2000 mm, 3000 mm, 4000 mm.
The standard profile length tolerance is +2 mm.
For more details please see page 1.08.

ACCESSORIES



COVERS

B slide cover
 colours: transparent, frosted, opal
 material: PC, PP, PP



Note! Dimensions of the space to install LED source

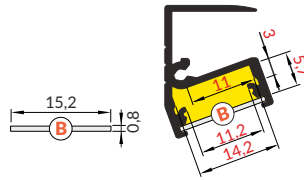

B transparent
 76250016

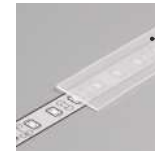

B frosted
 76250039

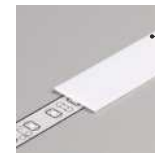

B opal
 76250038



C transparent
 76330000



C opal
 76330038



C lens
 76300000

C click cover
 colours: transparent, opal
 material: PMMA

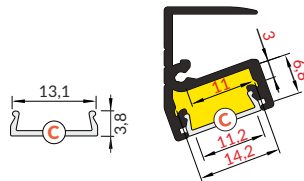

C lens click cover
 colour: transparent
 material: PC

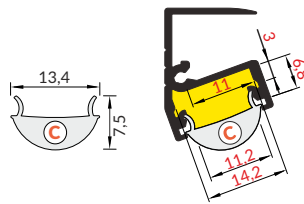



The standard cover length tolerance is +20 mm.
 For more details please see page 1.08.

ENDINGS

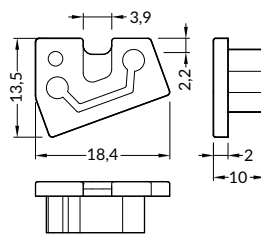
EDGE10 ending gen2 with hole
 colours: white, silver, black, grey
 material: ABS



INDEX = 1 set
 package = 10 sets = 20 pcs

-  white A9950001
-  silver A9950040
-  black A9950002
-  grey A9950022

THERMAL TAPE

thermal tape 45 x 10 mm
 self adhesive, double-sided

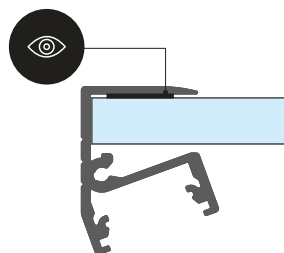

INDEX = 1 pc

53820000



Depending on the installation method, EDGE10 profile may illuminate the display area from the top or from below.



MIKRO-LINE12 J

EDGE PROFILE FOR GLASS PANELS

- decorative illumination
- illuminates the edge or engraving on the glass panel surface
- for furniture and advertisement use mainly
- fits the 8 mm glass panels
- note: the profile is not a construction element
- maximum LED strip width: 12 mm

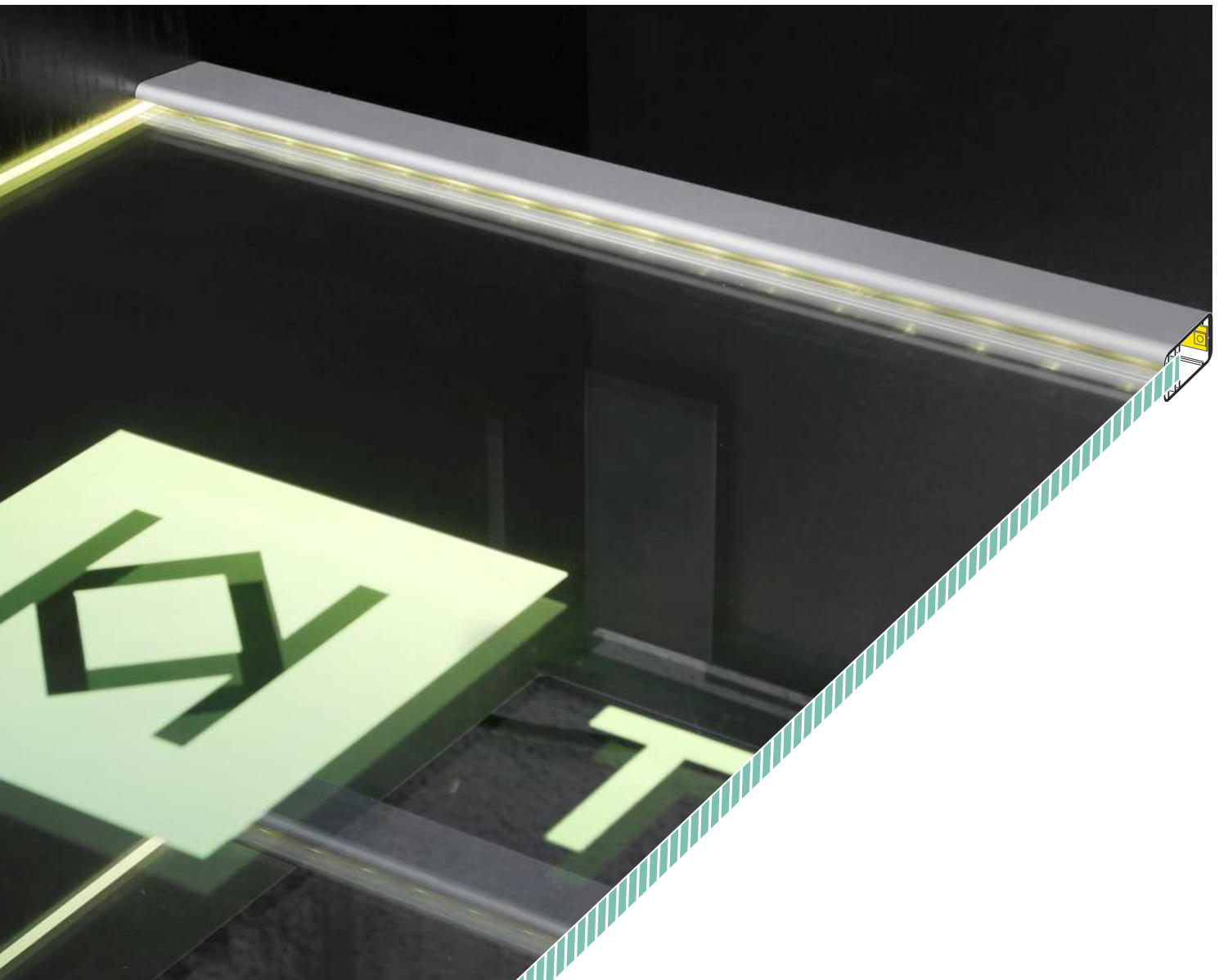

SIMILAR IN THE OFFER



TWIN8



EDGE10
BC



MIKRO10



CABI12
E

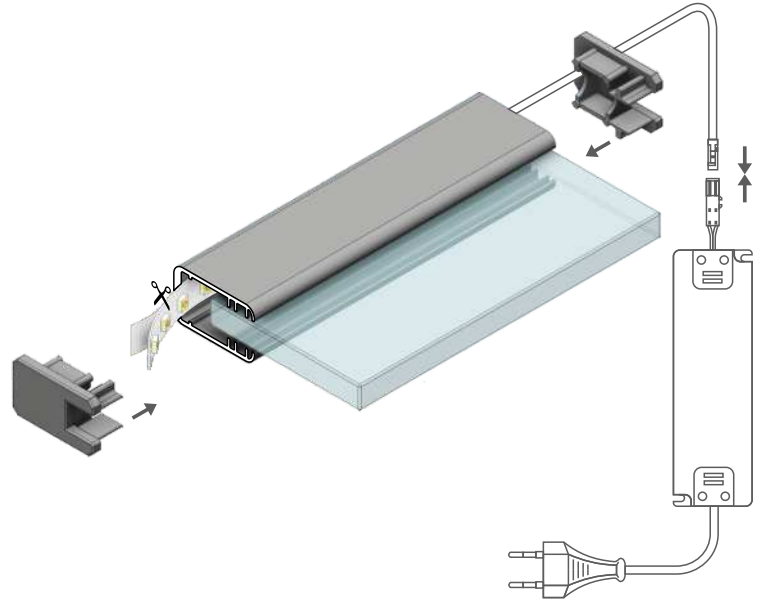
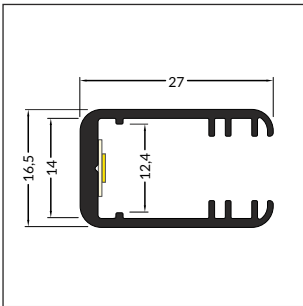
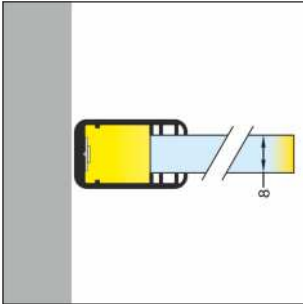



max 12 mm



glass application



INDEX = 1 pc, length 2000 mm
package = 10 pcs

-  anodized
70280020
-  raw aluminium
70280000



Available lengths: 1000 mm, 2000 mm, 3000 mm, 4000 mm. The standard profile length tolerance is +2 mm. For more details please see page 1.08.

ENDINGS

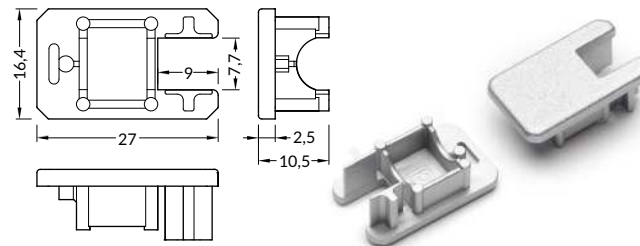
MIKRO-LINE12 ending
colours: silver, grey, transparent
material: ABS, ABS, PC



INDEX = 1 set
package = 10 sets = 20 pcs

-  silver 70290040
-  grey 70290022
-  transparent 70290000





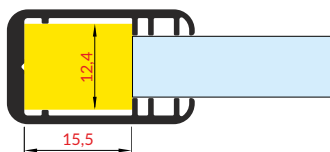

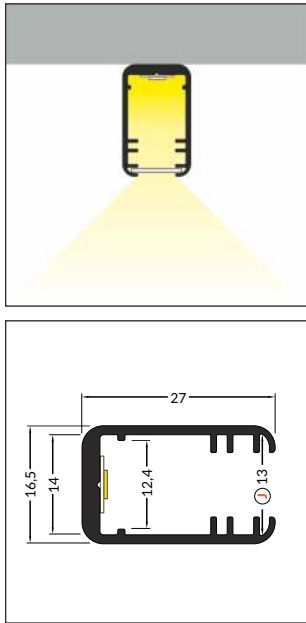
Note! Dimensions of the space to install LED source



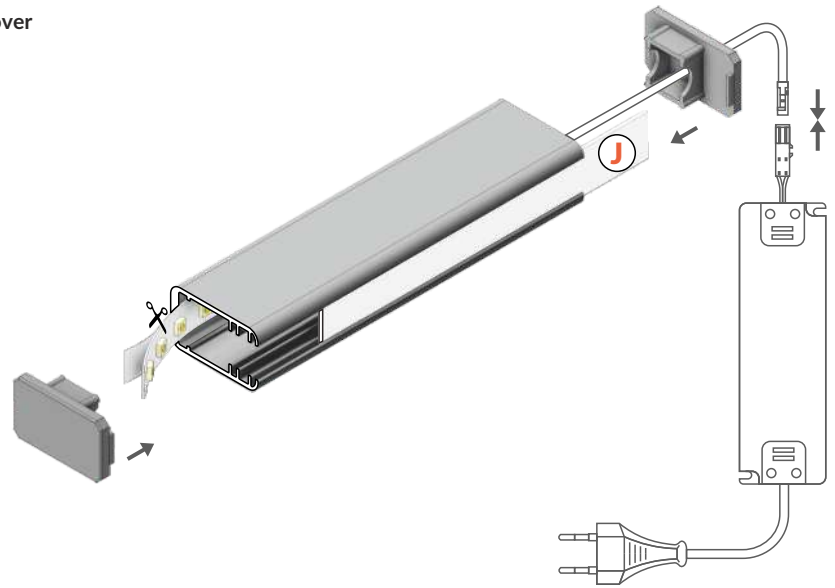



J slide cover



-  max 12 mm
-  special application
- 



INDEX = 1 pc, length 2000 mm
package = 10 pcs

-  anodized
70280020
-  raw aluminium
70280000



Available lengths: 1000 mm, 2000 mm, 3000 mm, 4000 mm. The standard profile length tolerance is +2 mm. For more details please see page 1.08.

ENDINGS

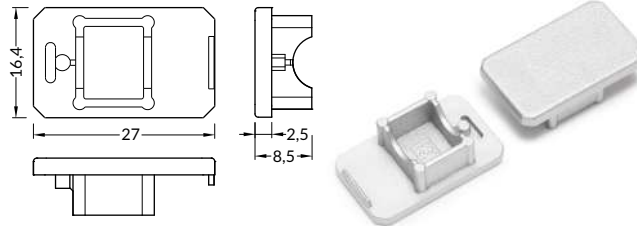
MIKRO-LINE12 LINIA ending
colours: silver, grey, transparent
material: ABS, ABS, PC



INDEX = 1 set
package = 10 sets = 20 pcs

-  silver 70300040
-  grey 70300022
-  transparent 70300000

COVERS

J slide cover
colours: transparent, frosted, opal
material: PC, PP, PP

Note! Dimensions of the space to install LED source

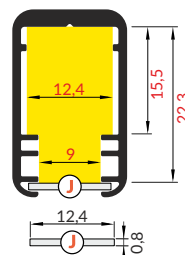

INDEX = 1 pc, length 2000 mm
package = 10 pcs

J transparent
70330016

J frosted
70330039

J opal
70330038

The standard cover length tolerance is +20 mm. For more details please see page 1.08.

PROFILE APPLICATION:

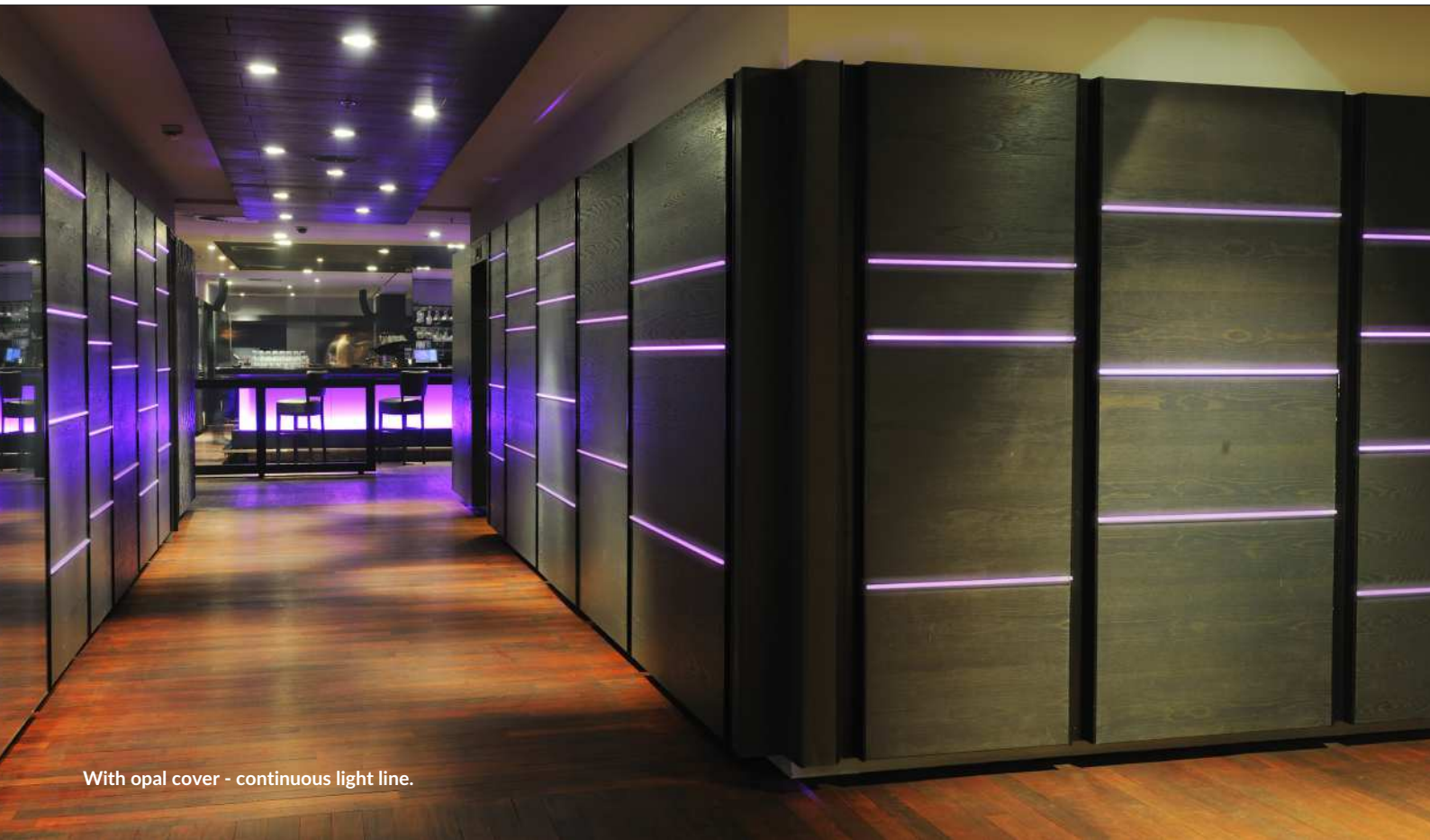

With opal cover - continuous light line.



With glass panel - illumination of sandblasted edge.

VARIO30



VARIOUS LIGHT IDEAS

- 18 variations and combinations
- from pendant to recessed
- housing around the powering supply
- continuous light line in angular connections
- unlimited possibilities in creating light

an example **variant 18**

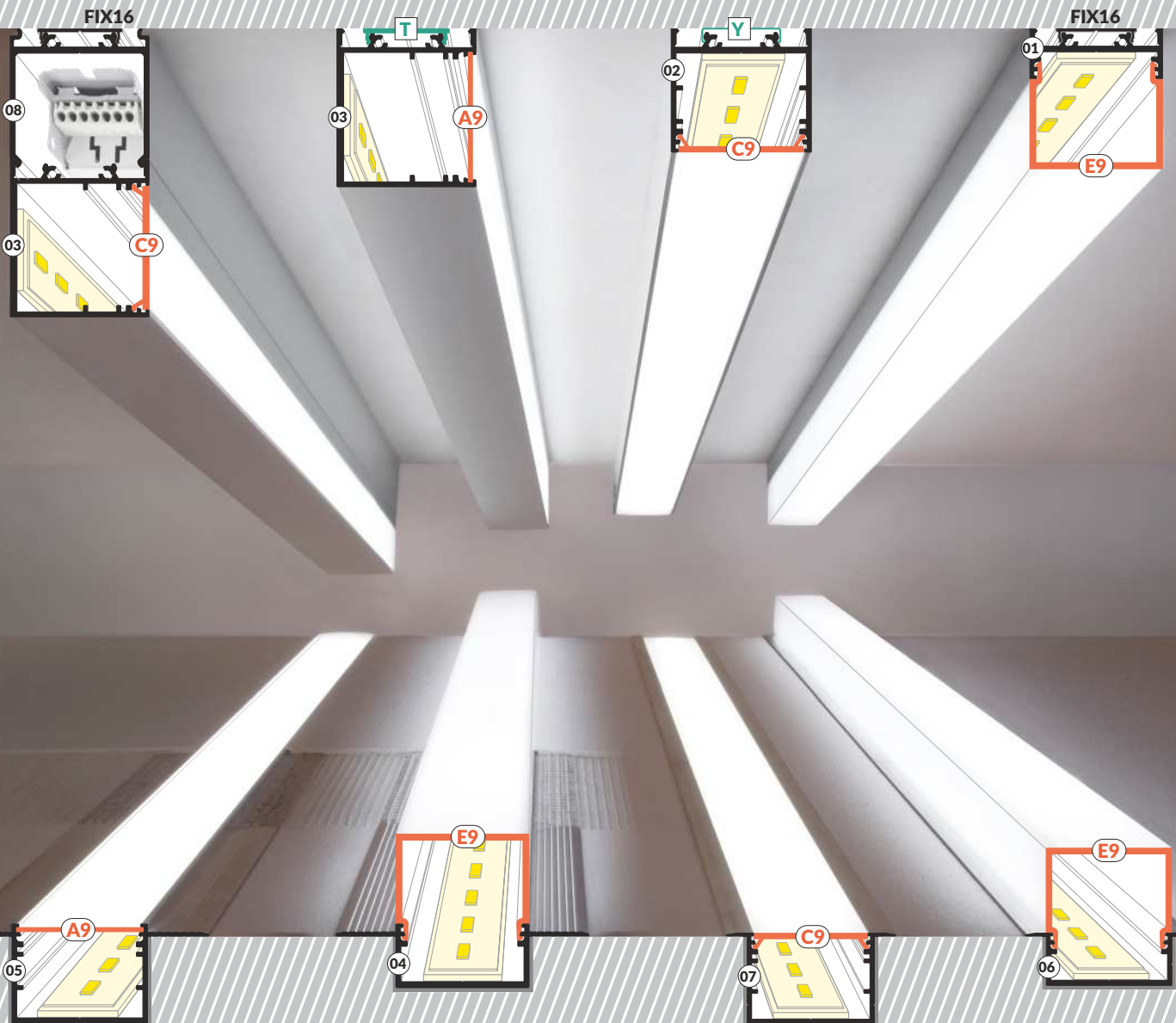
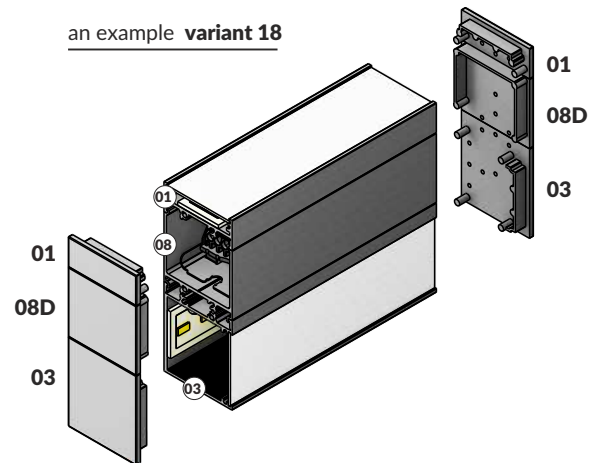

PROMOTED VARIANTS

variant 27 - pendant 09-08-02-C9

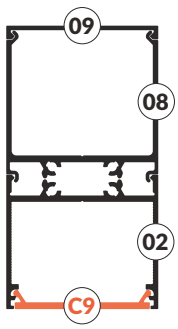

variant 15 - ceiling FIX16-08-01-E9

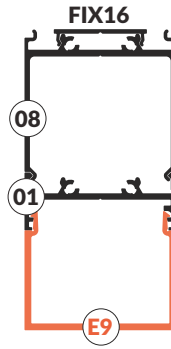

variant 32 - wall side FIX16-08-03-A9

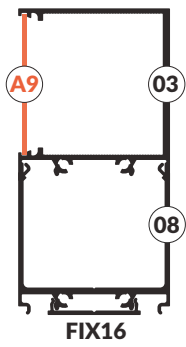

variant 11 - furniture FIX16-01-C9

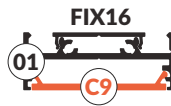

variant 06 - recessed 06-E9

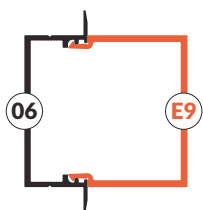

variant 05 - recessed 05-A9 spackle flange

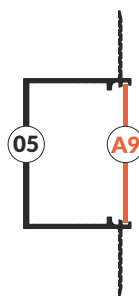

PROMOTED VARIANTS

BASIC VARIANTS

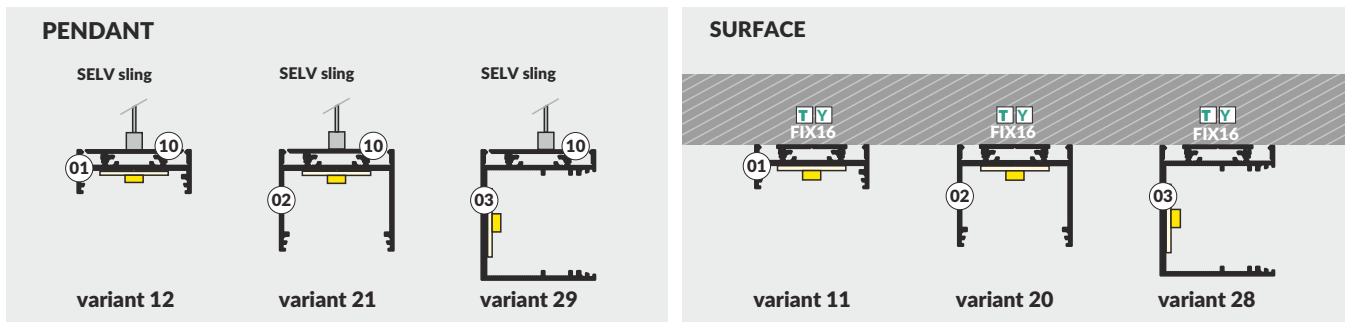

VARIANTS WITH POWER SUPPLY COVER

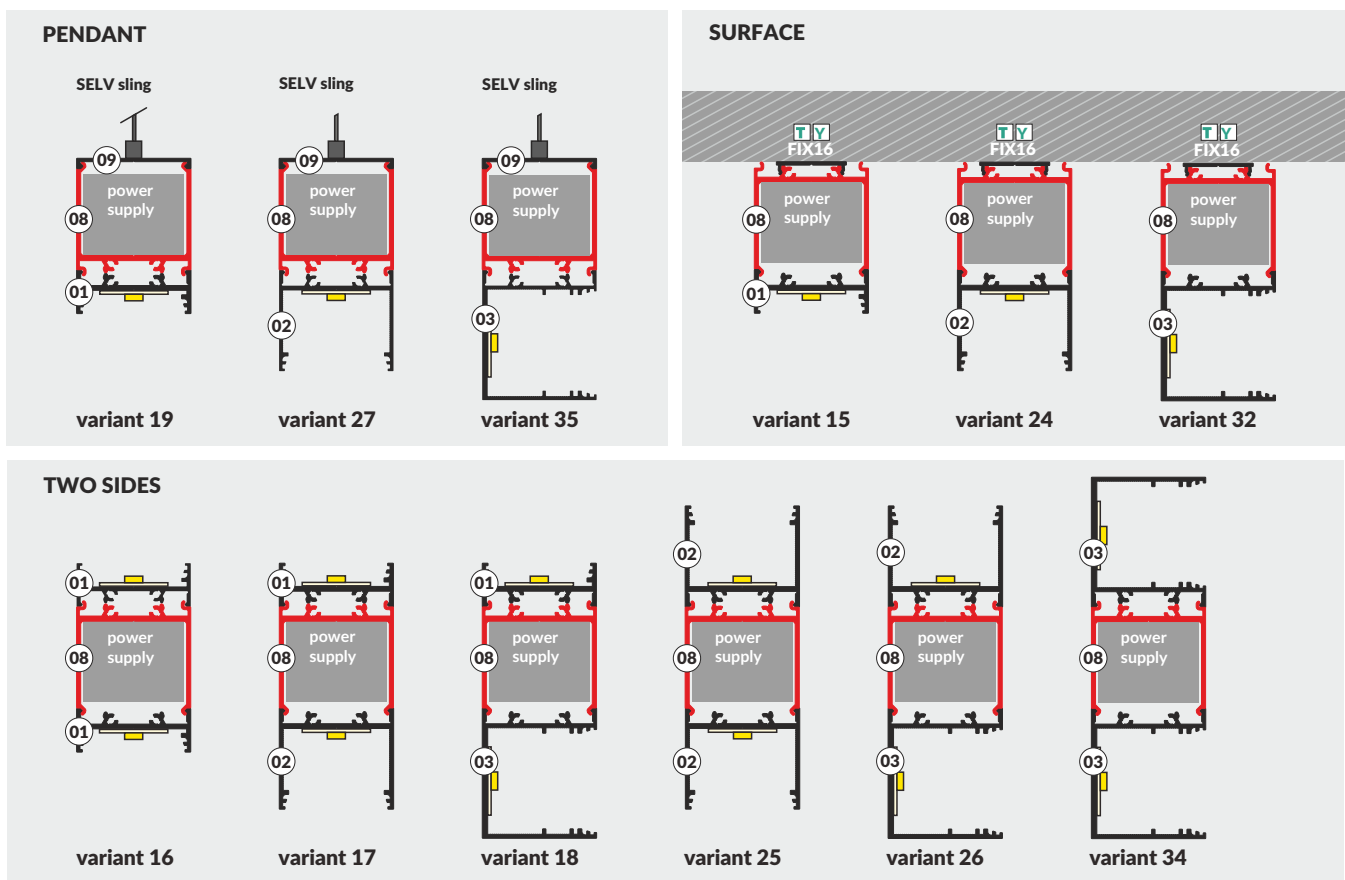

RECESSED VARIANTS

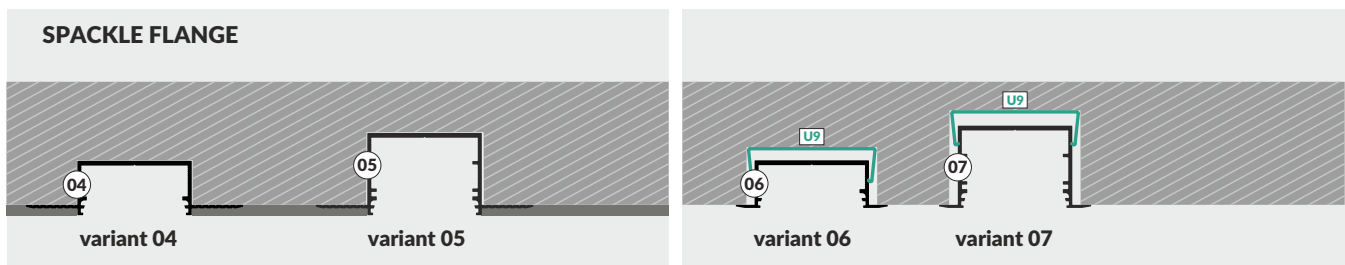

VARIO30

SURFACE

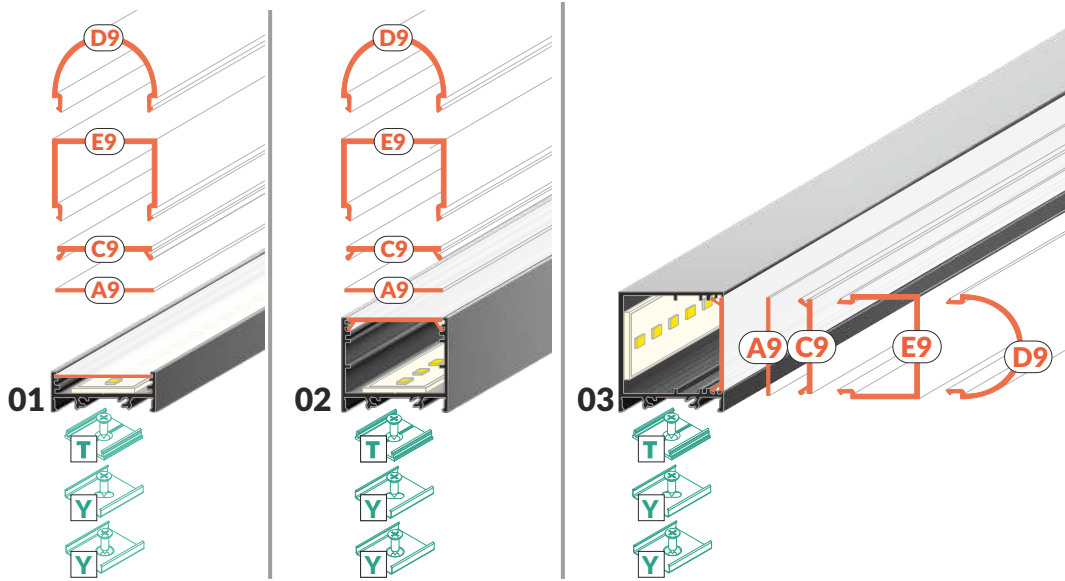

POWER SUPPLY COVER

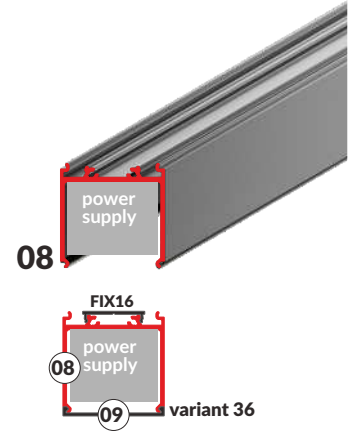

ASSISTANT PROFILES

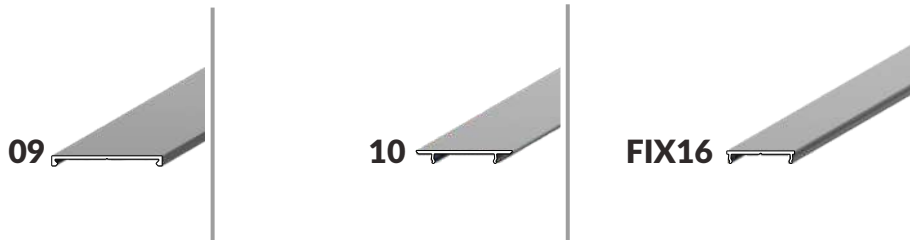

RECESSED SPACKLE FLANGE

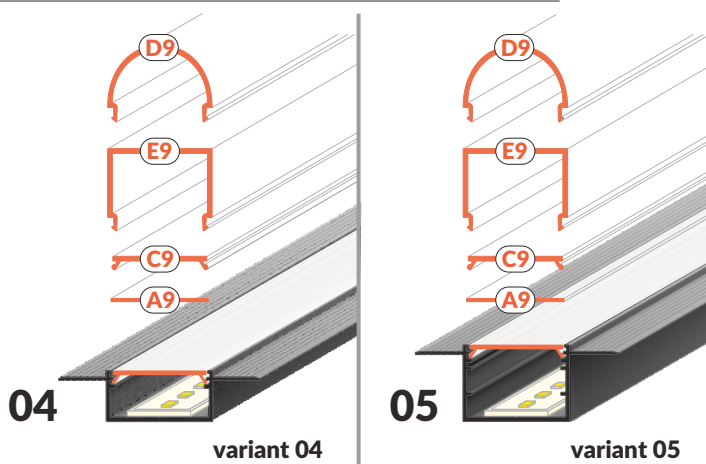

RECESSED

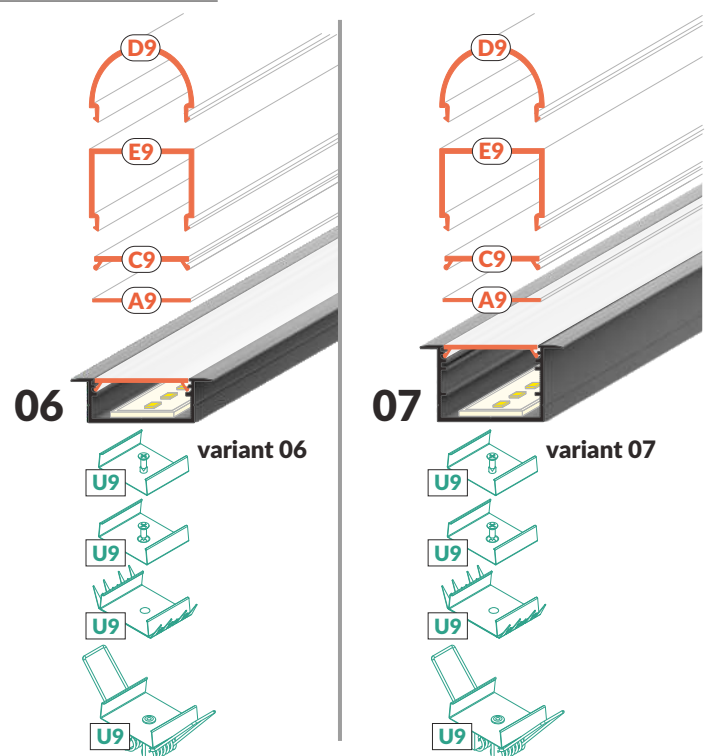

SURFACE PROFILES



VARIO30-01 > 7.06
VARIO30-02 > 7.06
VARIO30-03 > 7.06
VARIO30-08 > 7.06

VARIO30-09 > 7.07
VARIO30-10 > 7.07
FIX16 > 7.07

mountings > 7.08
endings > 7.09
i connectors > 7.12

diffusers others > 7.18
> 7.22

SURFACE, POWER SUPPLY COVER



LED profile VARIO30-01

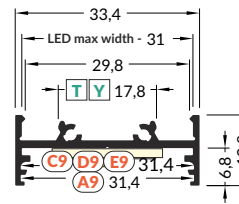
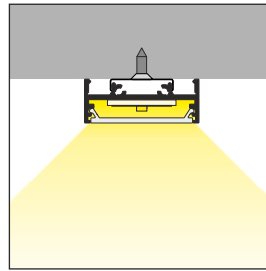

white anodized black raw

V3020001 V3020020 V3020021 V3020000

INDEX = 1 pc, length 2000 mm, package = 10 pcs

LED profile VARIO30-02

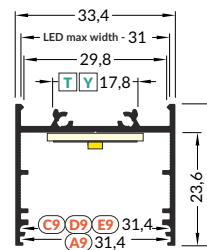
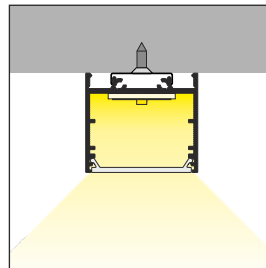

white anodized black raw

V3060001 V3060020 V3060021 V3060000

INDEX = 1 pc, length 2000 mm, package = 10 pcs

LED profile VARIO30-03

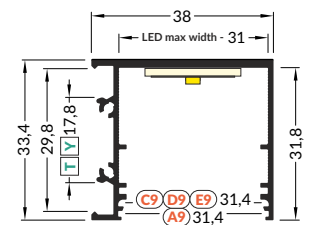
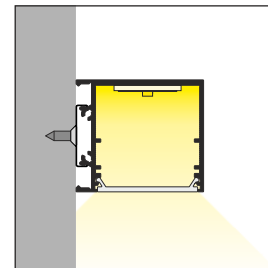
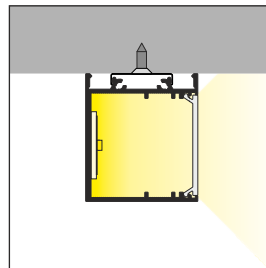

white anodized black raw

V3100001 V3100020 V3100021 V3100000

INDEX = 1 pc, length 2000 mm, package = 10 pcs

power supply profile VARIO30-08

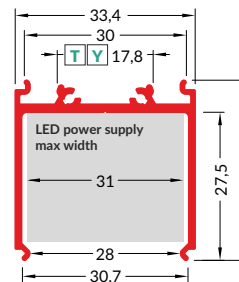
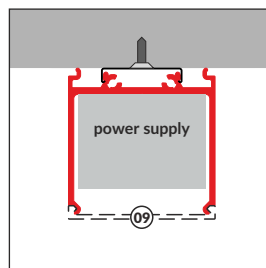

white anodized black raw

V3300001 V3300020 V3300021 V3300000

INDEX = 1 pc, length 2000 mm, package = 10 pcs

Available lengths: 1000 mm, 2000 mm, 3000 mm, 4000 mm. The standard profile length tolerance is +2 mm. For more details please see page 1.08.



cover
VARIO30-09

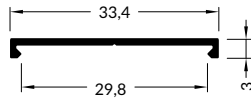

white anodized black raw

V3340001 V3340020 V3340021 V3340000

INDEX = 1 pc, length 2000 mm, package = 10 pcs

cover
VARIO30-10

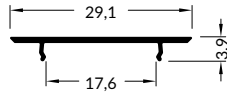

white anodized black raw

V3380001 V3380020 V3380021 V3380000

INDEX = 1 pc, length 2000 mm, package = 10 pcs

LED profile
FIX16

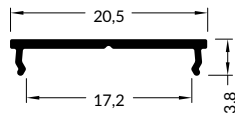

white anodized black raw

C6020001 C6020020 C6020021 C6020000

INDEX = 1 pc, length 2000 mm, package = 10 pcs



Y flexible mounting plate

material: stainless steel a

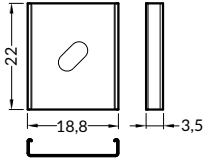

cone Y flexible mounting plate

material: stainless steel

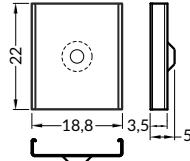

T mounting plate

material: aluminium

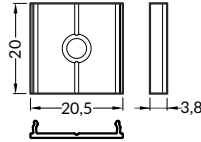

tilted bracket

material: stainless steel, plastic

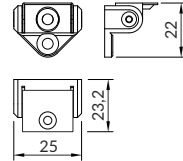

please note you need the Y mounting plate that is not included

mountings	inox	raw aluminium		
Y flexible mounting plate	A2090019	-		
cone Y flexible mounting plate	A2130019	-		
T mounting plate	-	C6960000		
	white	silver	black	grey
tilted bracket	67230001	67230040	67230002	67230022

INDEX = 1 set, package = 10 sets = 20 pcs

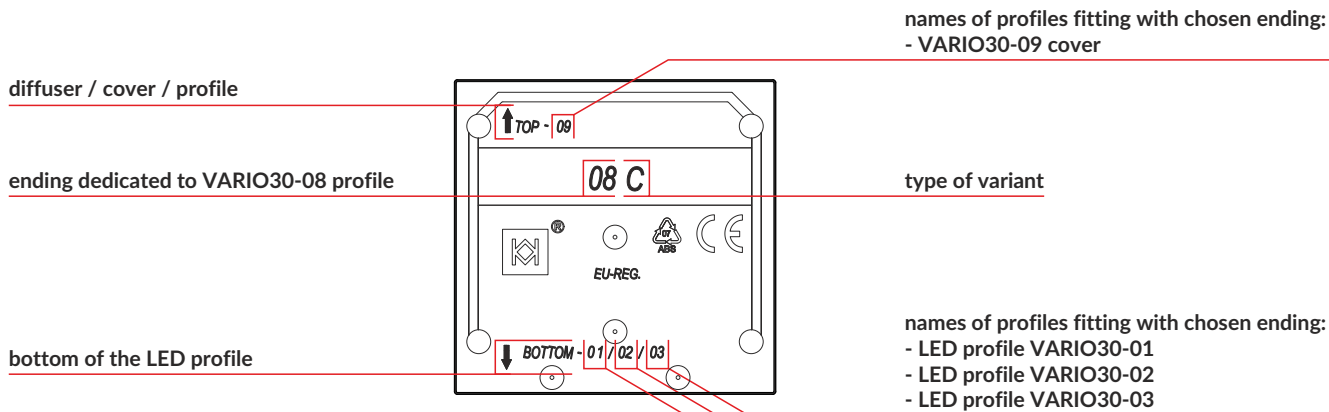

an example VARIANT 18

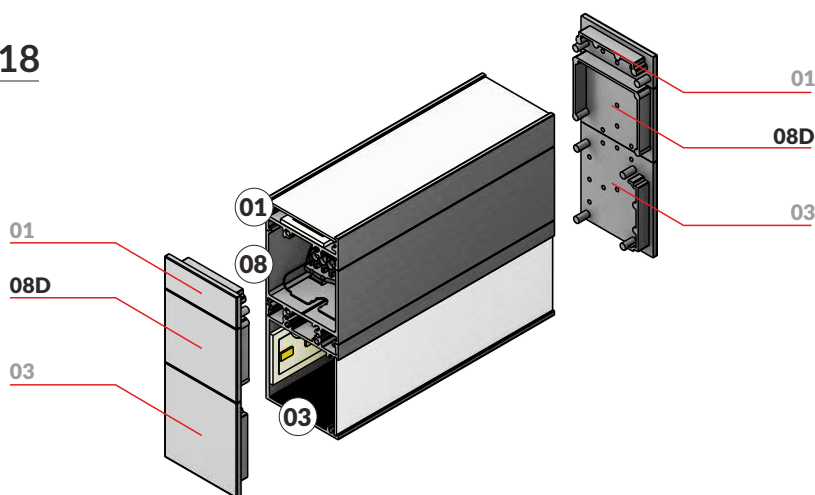

ENDINGS

material: ABS

VARIO30-01 ending

VARIO30-02 ending

VARIO30-03 ending

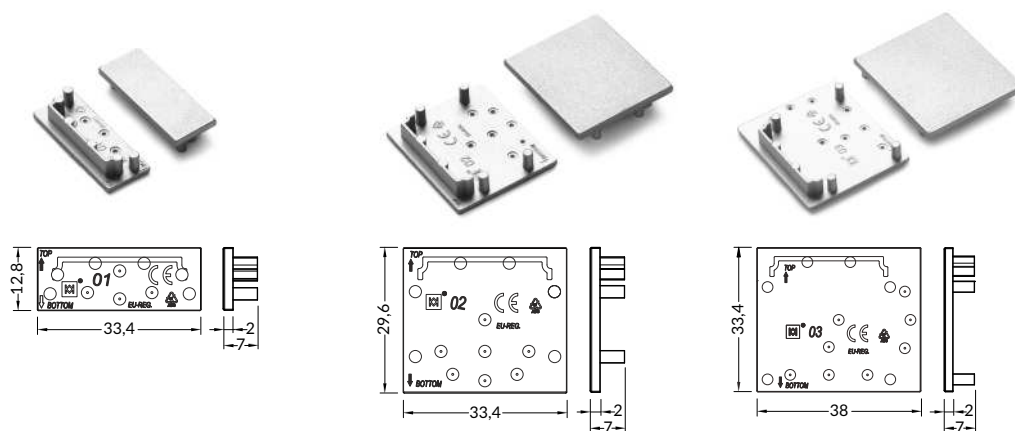

ending for profile

white

silver

black

grey

VARIO30-01	V4870001	V4870040	V4870002	V4870022
VARIO30-02	V4880001	V4880040	V4880002	V4880022
VARIO30-03	V4890001	V4890040	V4890002	V4890022

INDEX = 1 set, package = 10 sets = 20 pcs

08 ENDINGS

material: ABS



VARIO30-08A ending

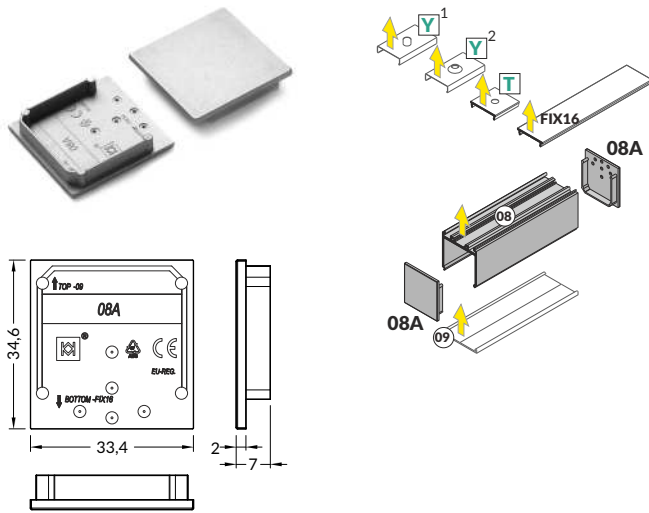

VARIO30-08B ending

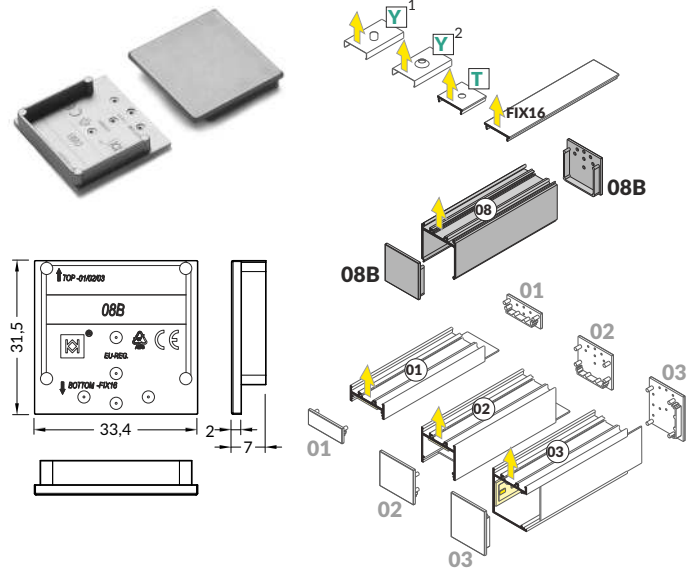

VARIO30-08C ending

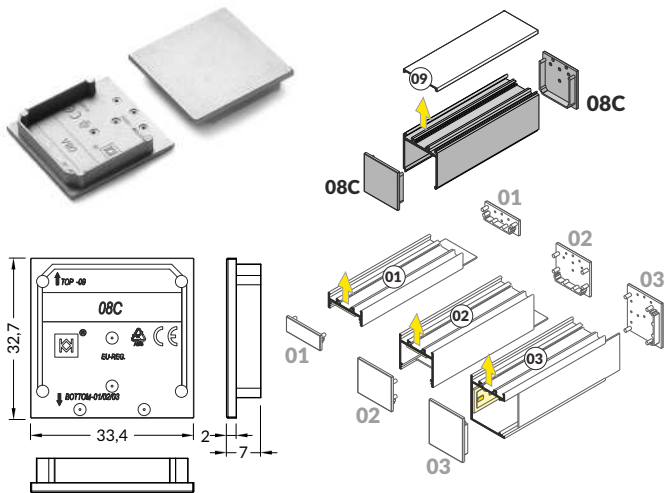

VARIO30-08D ending

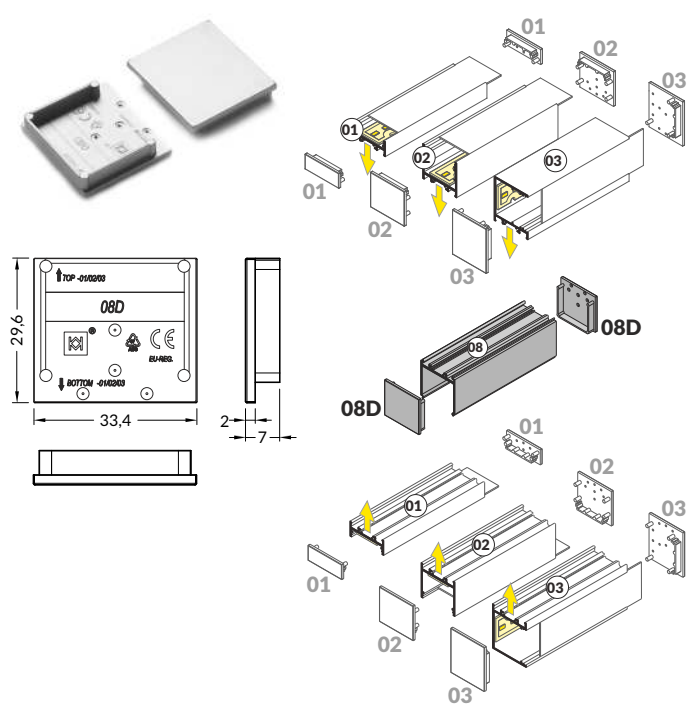

ending for profile

white

silver

black

grey

VARIO30-08ABCD

V4600001

V4600040

V4600002

V4600022

INDEX = 1 set = 2 x 08A + 2 x 08B + 2 x 08C + 2x08D

METAL ENDINGS

material: steel



VARIO30-16-E9 metal ending

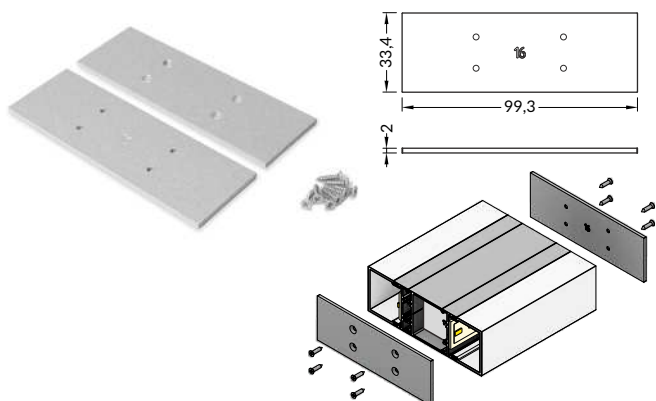

VARIO30-19-E9 metal ending

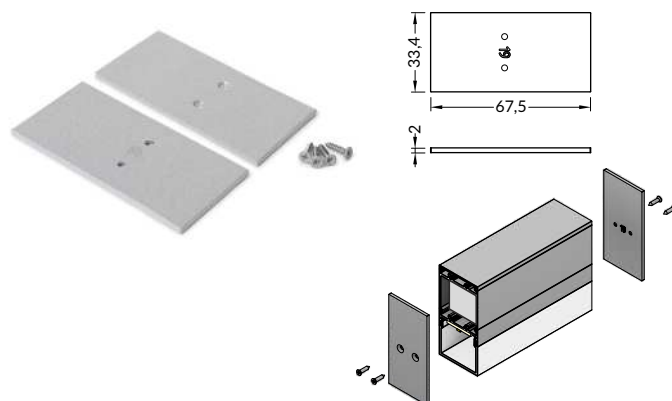

VARIO30-27 metal ending

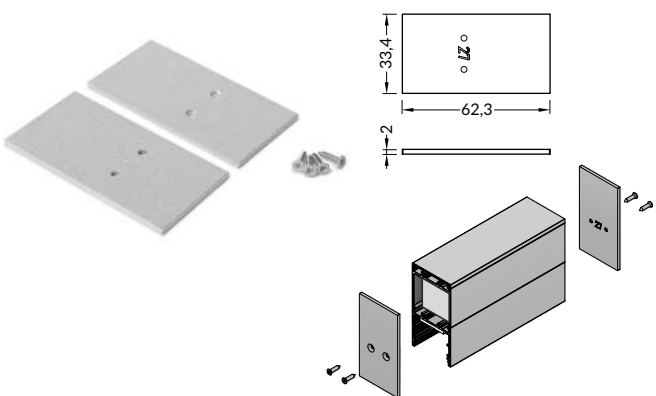

VARIO30-32 metal ending

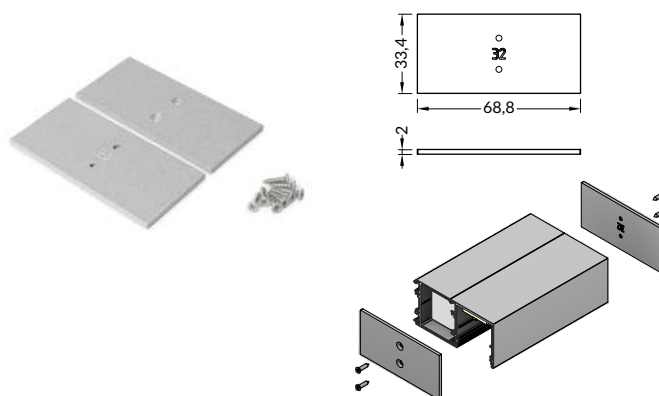

VARIO30-34 metal ending

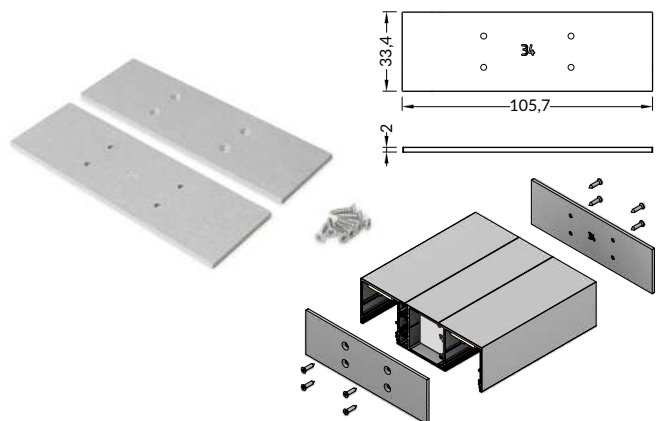

ending for variant

white

silver

black

VARIO30-16	V4550001s	V4550022s	V4550002s
VARIO30-19	V4560001s	V4560022s	V4560002s
VARIO30-27	V4570001s	V4570022s	V4570002s
VARIO30-32	V4580001s	V4580022s	V4580002s
VARIO30-34	V4590001s	V4590022s	V4590002s

INDEX = 1 set = 2 pcs

CONNECTORS

material: aluminium, PC

for profiles VARIO30-02

60 deg

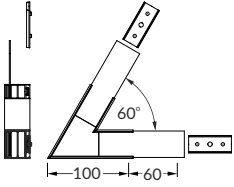

90 deg

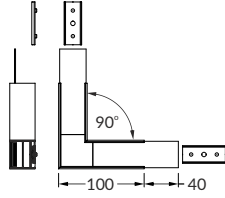

90 deg bent

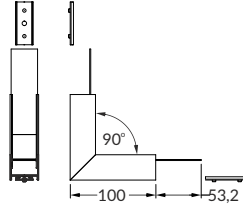

120 deg

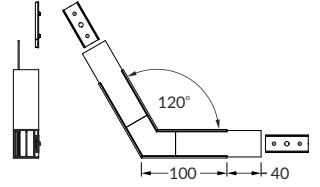

135 deg

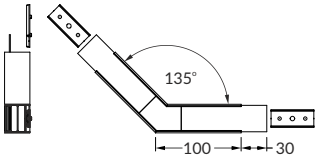

180 deg

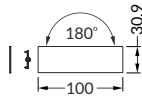

270 deg bent

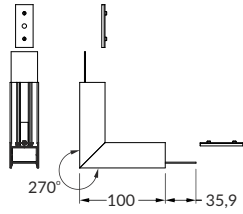

white

anodized

black

VARIO30-02 connector 60 deg	V4660001s	V4660020s	V4660021s
VARIO30-02 connector 90 deg	V4670001s	V4670020s	V4670021s
VARIO30-02 connector 90 deg bent	V4680001s	V4680020s	V4680021s
VARIO30-02 connector 120 deg	V4690001s	V4690020s	V4690021s
VARIO30-02 connector 135 deg	V4700001s	V4700020s	V4700021s
VARIO30-0203 connector 180 deg	-	-	V4640000s
VARIO30-02 connector 270 deg bent	V4710001s	V4710020s	V4710021s

for profiles

VARIO30-03

180 deg

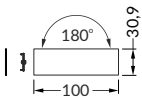

white

anodized

black

VARIO30-0203 connector 180 deg INDEX = 1 pc	-	-	-	V4640000s
---	---	---	---	-----------

RECESSED PROFILES

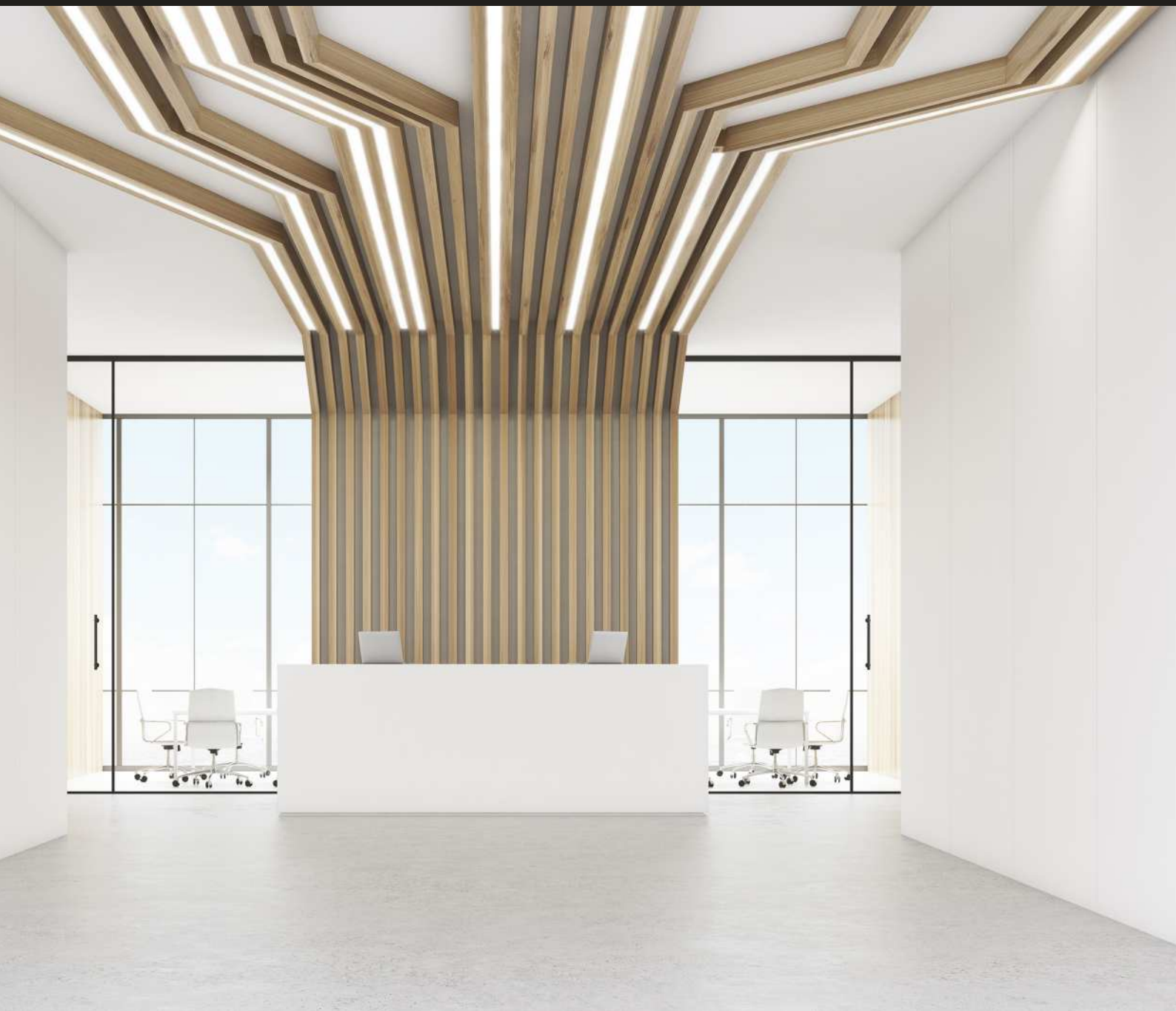

VARIO30-04
VARIO30-05
VARIO30-06
VARIO30-07

> 7.14
> 7.14
> 7.14
> 7.14

mountings
endings
connectors

> 7.15
> 7.15
> 7.16

diffusers
others

> 7.18
> 7.22

RECESSED PROFILES



LED profile VARIO30-04

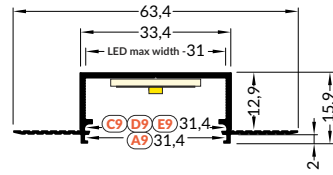
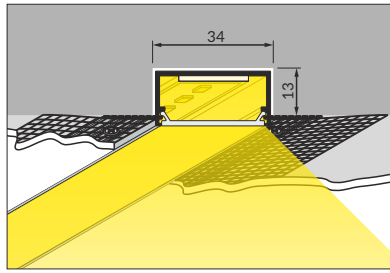

white anodized black raw

V3140001 V3140020 - V3140000

INDEX = 1 pc, length 2000 mm, package = 10 pcs

LED profile VARIO30-05

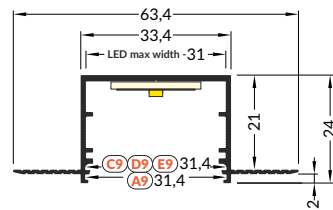
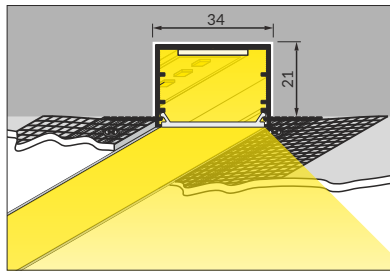

white anodized black raw

V3180001 V3180020 - V3180000

INDEX = 1 pc, length 2000 mm, package = 10 pcs

LED profile VARIO30-06

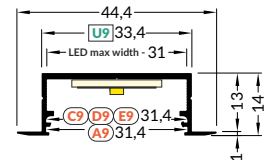
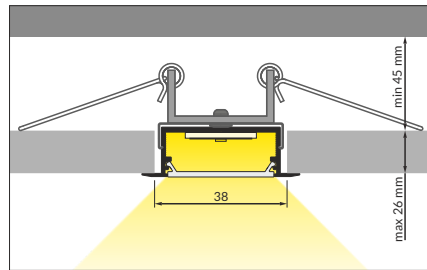
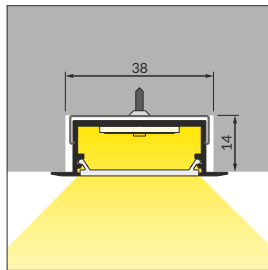

white anodized black raw

V3220001 V3220020 V3220021 V3220000

INDEX = 1 pc, length 2000 mm, package = 10 pcs

LED profile VARIO30-07

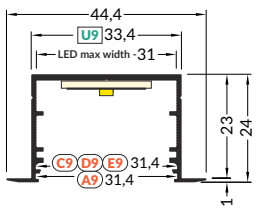
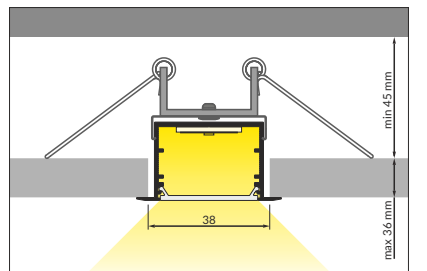
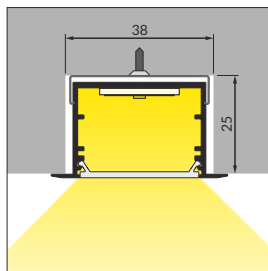

white anodized black raw

V3260001 V3260020 V3260021 V3260000

INDEX = 1 pc, length 2000 mm, package = 10 pcs

Available lengths: 1000 mm, 2000 mm, 3000 mm, 4000 mm. The standard profile length tolerance is +2 mm. For more details please see page 1.08.

ACCESSORIES

MOUNTINGS

U9 mounting plate

material: stainless steel

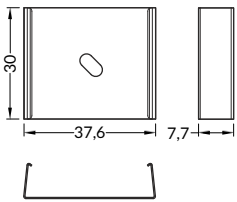

cone U9 mounting plate

material: stainless steel

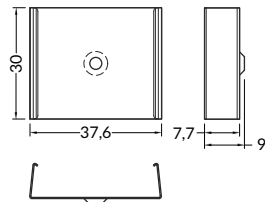

rack U9 mounting plate

material: stainless steel

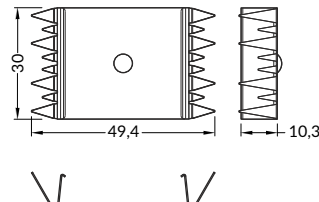

spring U9 mounting plate

material: stainless steel, aluminium

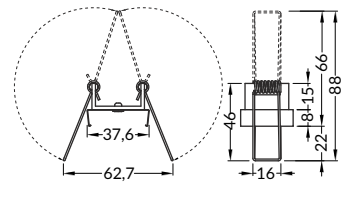

mountings

inox

U9 mounting plate

V4840019

cone U9 mounting plate

V4850019

rack U9 mounting plate

V4860019 INDEX = 1 set, package = 10 sets = 20 pcs spring U9 mounting plate

V4620019s INDEX = 2 pcs

ENDINGS

material: ABS

VARIO30-04 ending

VARIO30-05 ending

VARIO30-06 ending

VARIO30-07 ending

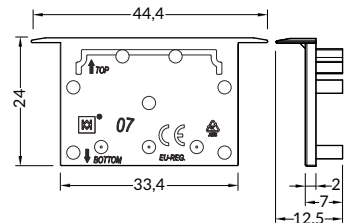
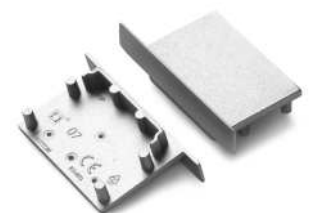
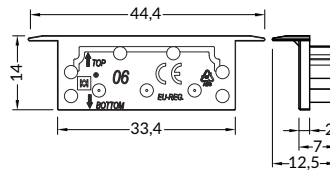
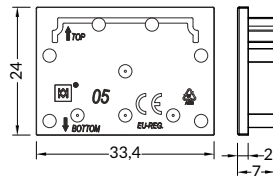
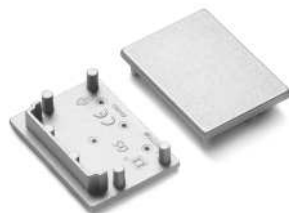
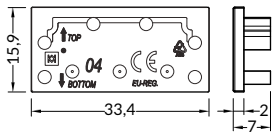

ending for profile

white

silver

black

grey

VARIO30-04

V4900001

V4900040

-

V4900022

VARIO30-05

V4910001

V4910040

-

V4910022

VARIO30-06

V4920001

V4920040

V4920040

V4920022

VARIO30-07

V4930001

V4930040

V4930002

V4930022

INDEX = 1 set, package = 10 sets = 20 pcs

CONNECTORS

material: aluminium, PC

for profiles

VARIO30-05

60 deg

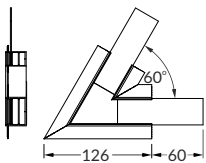

90 deg

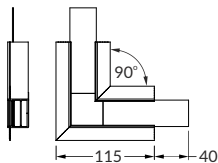

90 deg bent

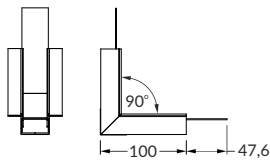

120 deg

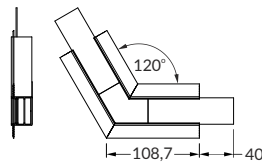

135 deg

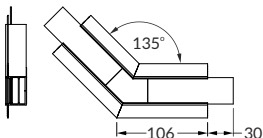

180 deg

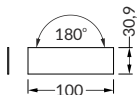

270 deg bent

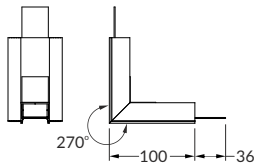

white

anodized

black

VARIO30-05 connector 60 deg	V4720001s	V4720020s	-
VARIO30-05 connector 90 deg	V4730001s	V4730020s	-
VARIO30-05 connector 90 deg bent	V4740001s	V4740020s	-
VARIO30-05 connector 120 deg	V4750001s	V4750020s	-
VARIO30-05 connector 135 deg	V4760001s	V4760020s	-
VARIO30-05 connector 180 deg	-	-	V4650000s
VARIO30-05 connector 270 deg bent	V4770001s	V4770020s	-

INDEX = 1 pc / .

for profiles

VARIO30-07

60 deg

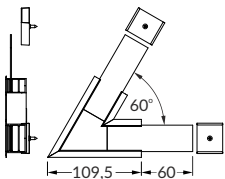

90 deg

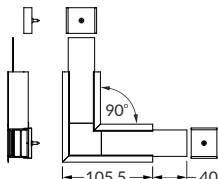

90 deg bent

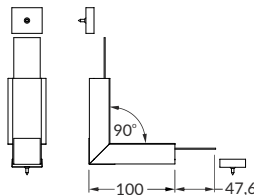

120 deg

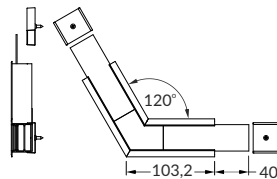

135 deg

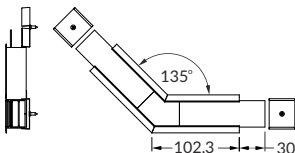

180 deg

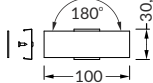

270 deg bent

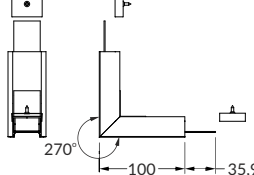

white

anodized

black

czarny

VARIO30-07 connector 60 deg	V4780001s	V4780020s	V4780002s
VARIO30-07 connector 90 deg	V4790001s	V4790020s	V4790002s
VARIO30-07 connector 90 deg bent	V4800001s	V4800020s	V4800002s
VARIO30-07 connector 120 deg	V4810001s	V4810020s	V4810002s
VARIO30-07 connector 135 deg	V4820001s	V4820020s	V4820002s
VARIO30-07 connector 180 deg	-	-	V4610000s
VARIO30-07 connector 270 deg bent	V4830001s	V4830020s	V4830002s

INDEX = 1 pc

SYSTEM ACCESSORIES

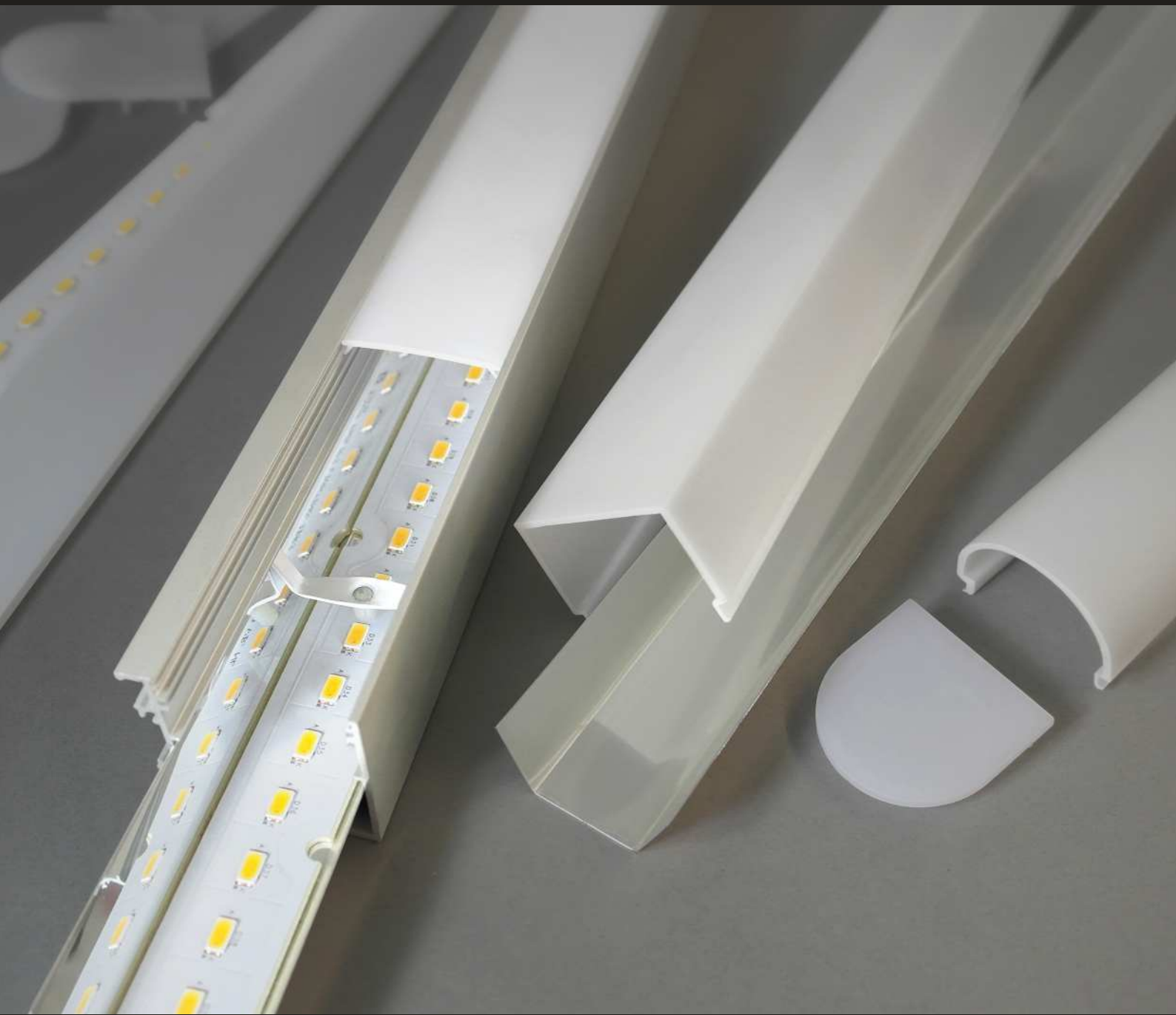

diffusers others /

> 7.18
> 7.22

DIFFUSERS

A9 slide diffuser

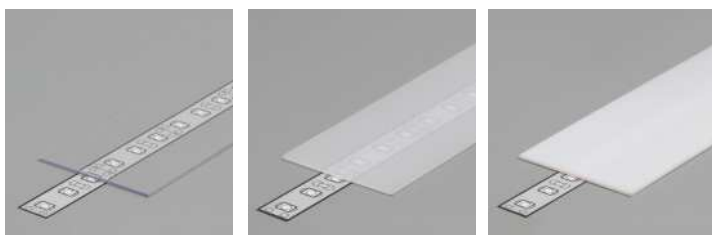

transparent
material: PC

frosted
material: PP

opal
material: PP

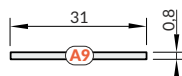

Note! Dimensions of the space to install LED source

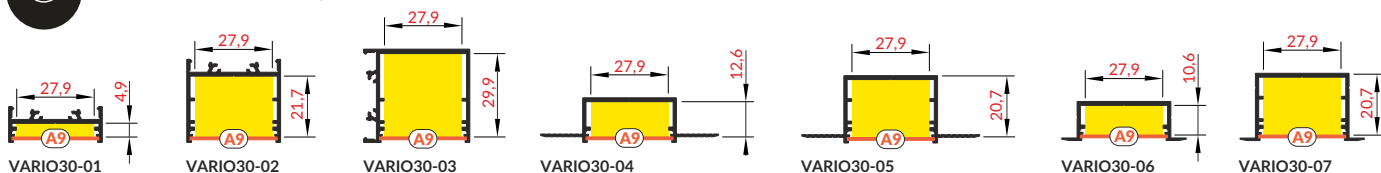

transparent

frosted

opal

A9 slide diffuser INDEX = 1 pc, length 2000

V3420016

V3420039

V3420038

mm, package = 10 pcs

C9 click diffuser



transparent
material: PMMA

opal
material: PMMA

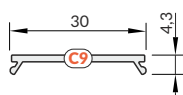

Note! Dimensions of the space to install LED source

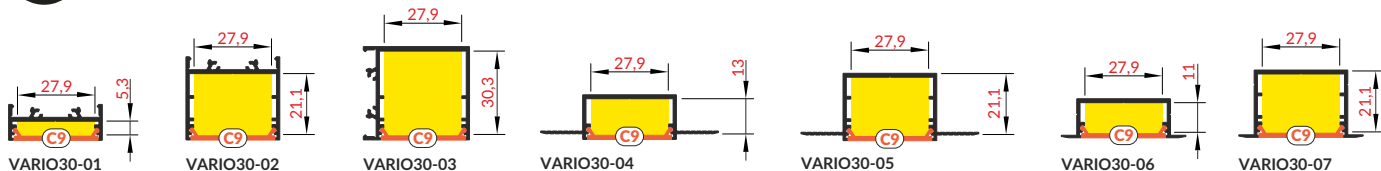

transparent

frosted

opal

C9 click diffuser

V3460016

-

V3460038

INDEX = 1 pc, length 2000 mm, package = 10 pcs

The standard diffuser length tolerance is +20 mm. For more details please see page 1.08.

DIFFUSERS



D9 click diffuser

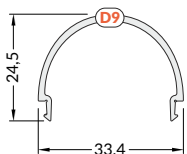

opal
material: PMMA



Note! Dimensions of the space to install LED source

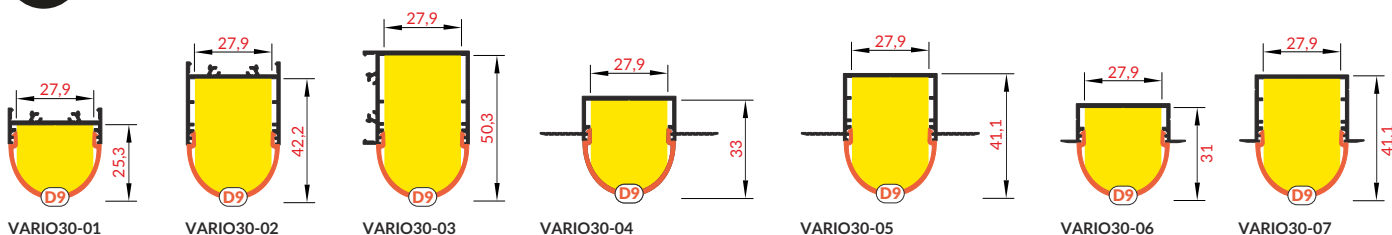

VARIO30-01

VARIO30-02

VARIO30-03

VARIO30-04

VARIO30-05

VARIO30-06

VARIO30-07

transparent

frosted

opal

D9 click diffuser

-

-

V3500038

INDEX = 1 pc, length 2000 mm, package = 10 pcs The standard diffuser length tolerance is +20 mm. For more details please see page 1.08.

ENDINGS FOR D9 DIFFUSER

material: PMMA

VARIO30-01-D9 ending

VARIO30-01-D9 ending

VARIO30-02-D9 ending

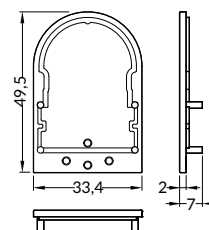
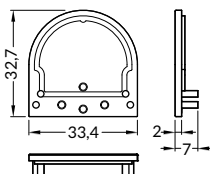
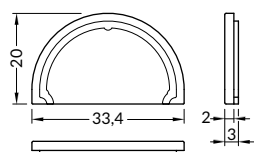
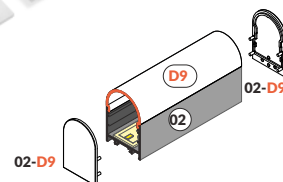
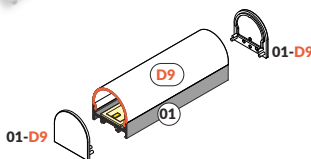
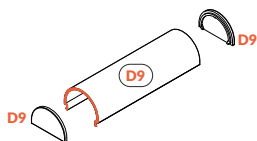

opal

D9 ending

V4980038

VARIO30-01-D9 ending

V4500038

VARIO30-02-D9 ending

V4540038

INDEX = 1 set, package = 10 sets = 20 pcs

DIFFUSERS

E9 click diffuser

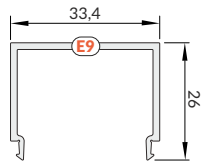

opal
material: PMMA



Note! Dimensions of the space to install LED source

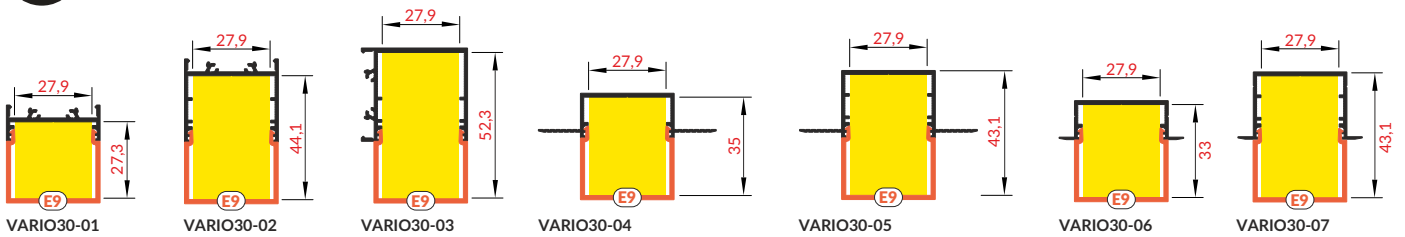

transparent frosted opal

E9 click diffuser

-

-

V3540038

INDEX = 1 pc, length 2000 mm, package = 10 pcs .The standard diffuser length tolerance is +20 mm. For more details please see page 1.08.

ENDINGS FOR E9 DIFFUSER

material: PMMA

E9 ending

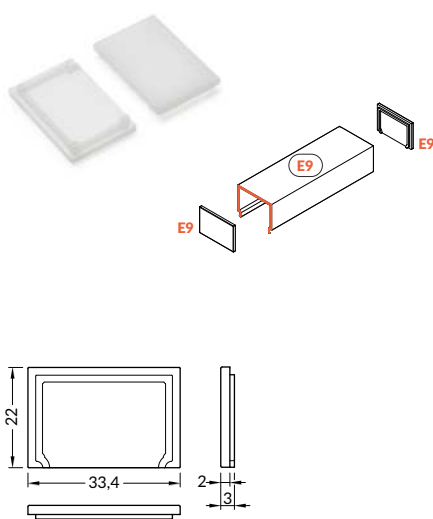

VARIO30-01-E9 ending

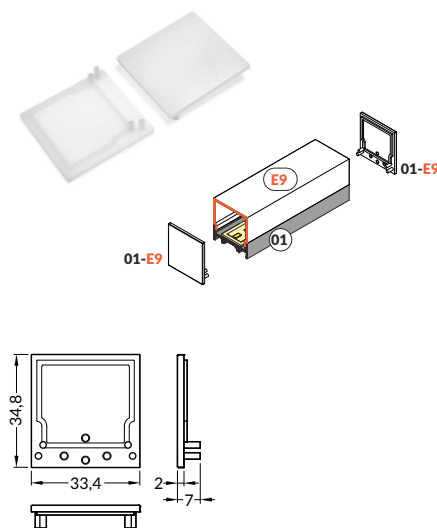

VARIO30-02-E9 ending

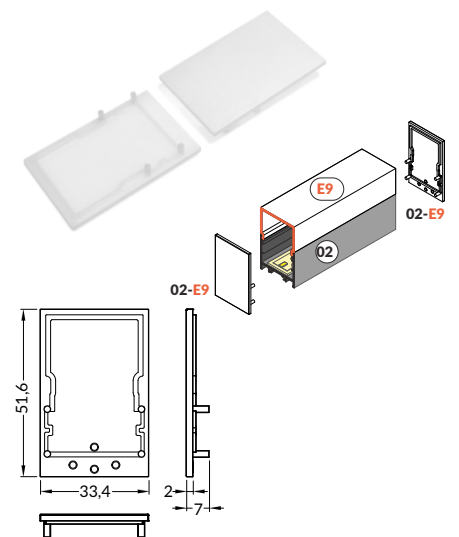

opal

E9 ending

V4990038

VARIO30-01-E9 ending

V4510038

VARIO30-02-E9 ending

V4550038

INDEX = 1 set, package = 10 sets = 20 pcs

LIGHTING EFFECT

VARIO30 reflector + VARIO30-1 LED clamp
-1



Recommended for profiles:

02, 03 > 7.06
05, 07 > 7.14
and diffusers:
A9, C9, D9, E9 > 7.19

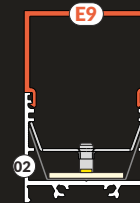

VARIO30 LED mounting + VARIO30 LED clamp



Recommended for profiles:

02, 03 > 7.06
05, 07 > 7.14
and diffusers:
A9, C9, D9, E9 > 7.19

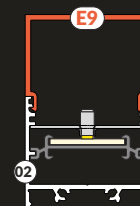
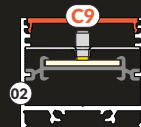

VARIO30-1 LED clamp



Recommended for profiles:

02, 03 > 7.06
05, 07 > 7.14
and diffusers:
A9, C9, D9, E9 > 7.19

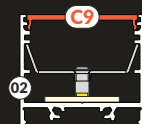

VARIO30 LED clamp



Recommended for profiles:
04, 06 > 7.14
and diffusers:

A9, C9, D9, E9 > 7.19

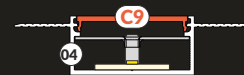

ACCESSORIES

VARIO30 LED clamp

material: steel, plastic

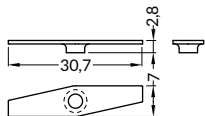

VARIO30-1 LED clamp

material: steel, plastic

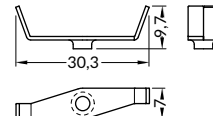

white painted

VARIO30 LED clamp

V4630001

VARIO30-1 LED clamp

V4520001

INDEX = 1 set, package = 10 sets = 20 pcs

VARIO30 reflector

material: aluminium

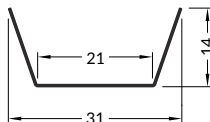

VARIO30 reflector INDEX = 1 pc, length 2000 mm, package = 10 pcs

V3620000

VARIO30 LED mounting mocowanie LED VARIO30

material: aluminium

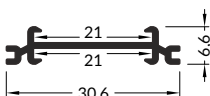

raw aluminium

V3580000

VARIO30 LED mounting INDEX = 1 pc, length 2000 mm, package = 10 pcs

Available lengths: 1000 mm, 2000 mm, 3000 mm, 4000 mm.
The standard profile length tolerance is +2 mm. For more details please see page 1.08.

BIG PROFILES





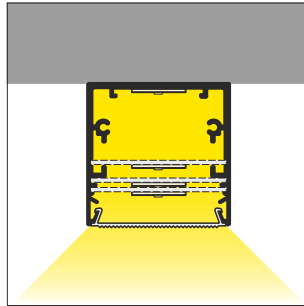
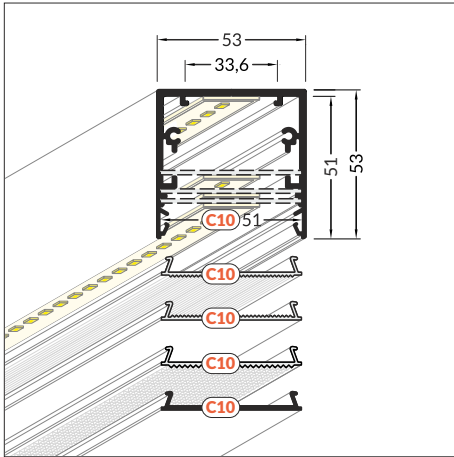

PHIL53 profile



Available lengths: 1000 mm, 2000 mm, 3000 mm, 4000 mm. The standard profile length tolerance is +2 mm. For more details please see page 1.08.



INDEX = 1 pc, length 2000 mm

-  white painted
63530001
-  anodized
63530020 black painted
-  63530002
raw aluminium
-  63530000

ENDINGS

PHIL53 ending
colours: white, silver, black, grey
material: ABS

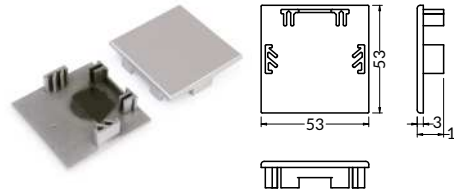

INDEX = 1 set = 2 pcs
= 2 szt.

-  white 63640001
-  silver 63640040
-  black 63640002
-  grey 63640022



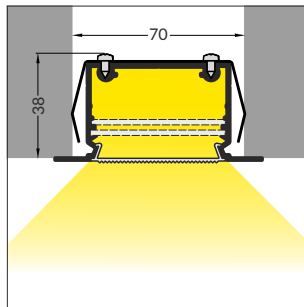
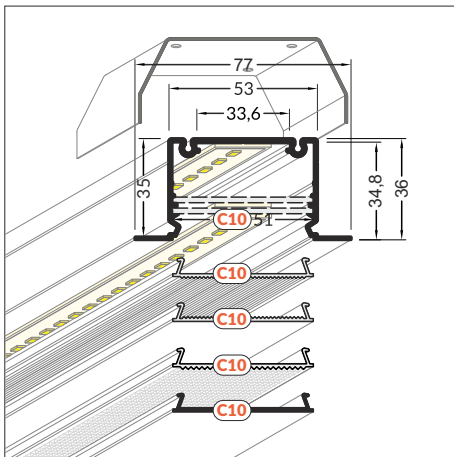

PHIL recessed profile



Available lengths: 1000 mm, 2000 mm, 3000 mm, 4000 mm. The standard profile length tolerance is +2 mm. For more details please see page 1.08.



INDEX = 1 pc, length 2000 mm

-  white painted
97100001
-  anodized
97100020 black painted
-  97100002
raw aluminium
-  97100000

MOUNTING

PHIL recessed holder
colour: inox
material: stainless steel



INDEX = 1 set = 2 pcs

-  inox 97510019

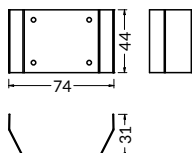



ENDINGS

PHIL recessed ending
colours: white, silver, black
material: steel



INDEX = 1 set = 2 pcs

-  white 97120001
-  silver 97120022
-  black 97120002

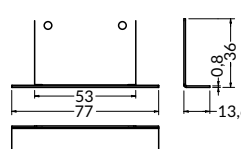



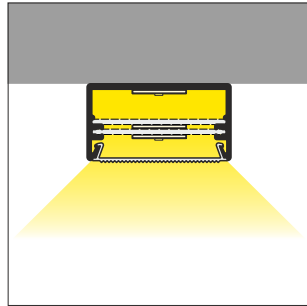
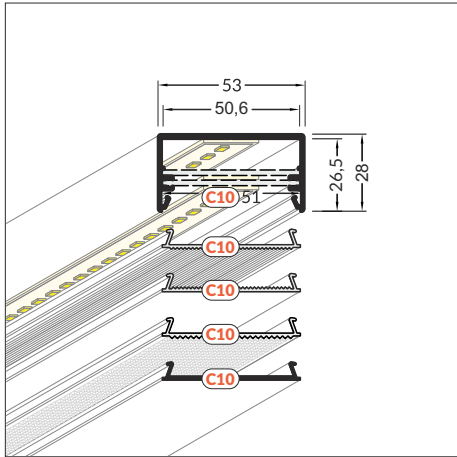

LOWI profile



Available lengths: 1000 mm, 2000 mm, 3000 mm, 4000 mm. The standard profile length tolerance is +2 mm. For more details please see page 1.08.



INDEX = 1 pc, length 2000 mm

-  white painted
93030001
-  anodized
93030020 black painted
-  black painted
93030002
-  raw aluminium
93030000

ENDINGS

LOWI ending colours: white, silver, black, grey
material: ABS

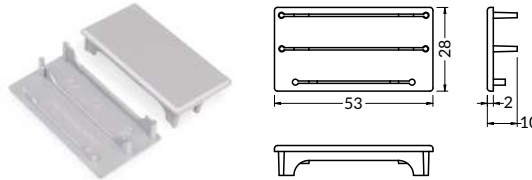

INDEX = 1 set = 2 pcs

-  white 93066001
-  silver 93070040
-  black 93070002
-  grey 93070022

COVERS

C10 NARROW cover
material: polycarbonate

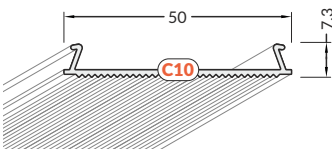

INDEX = 1 pc, length 2000 mm .

63620000

C10 WIDE cover
material: polycarbonate

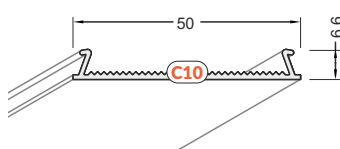

INDEX = 1 pc, length 2000 mm

63590000

C10 OPAL cover
material: PMMA

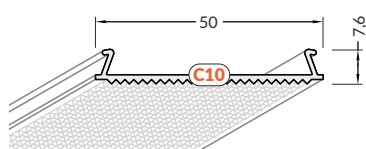

INDEX = 1 pc, length 2000 mm



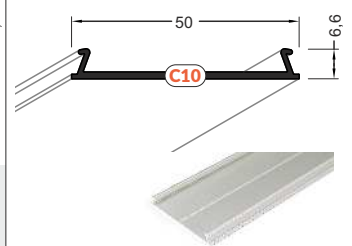

63690038

COVER

C10 aluminium cover
material: aluminium



INDEX = 1 pc, length 2000 mm ..

-  white painted
63560001
-  anodized
63560020
-  black painted
63560002
-  raw aluminium
63560000

Available lengths: 1000 mm, 2000 mm, 3000 mm, 4000 mm. The standard profile length tolerance is +2 mm. For more details please see page 1.08.

The standard cover length tolerance is +20 mm. For more details please see page 1.08.

Comparison of variations in the light curves measured on different C10 covers

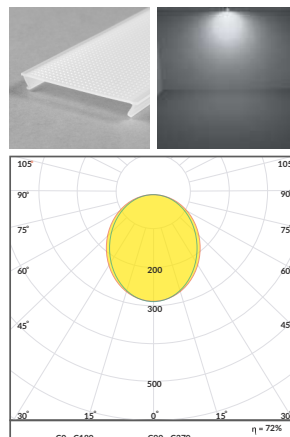
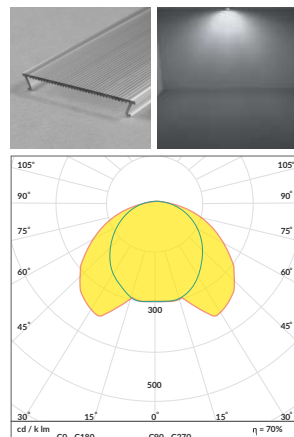
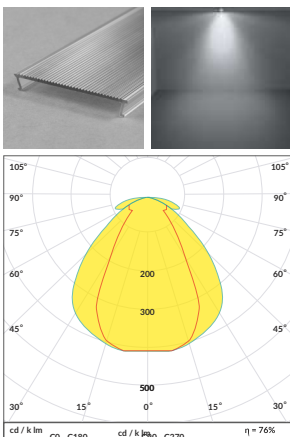

LED mounting 50
material: aluminium

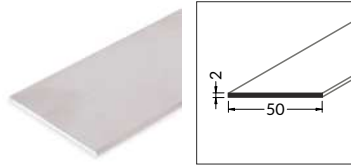

INDEX = 1 pc, length 2000 mm

raw aluminium

25090000

Available lengths: 1000 mm, 2000 mm, 3000 mm, 4000 mm. The standard profile length tolerance is +2 mm. For more details please see page 1.08.

DIMENSIONS TO INSTALL LIGHT SOURCE

PHIL53 profile

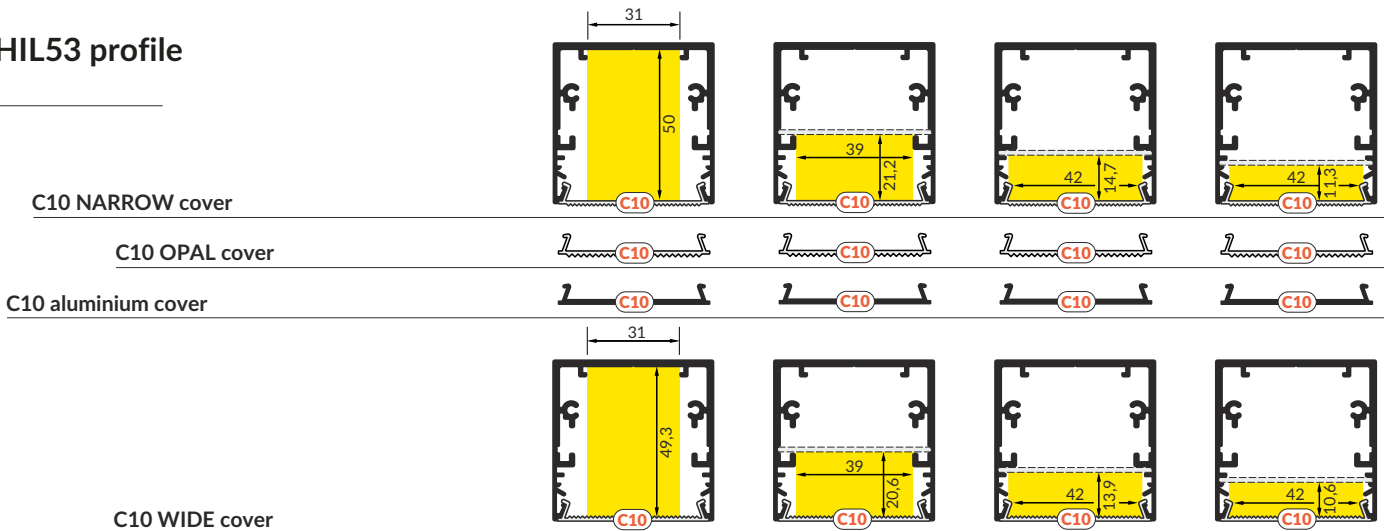

PHIL recessed profile

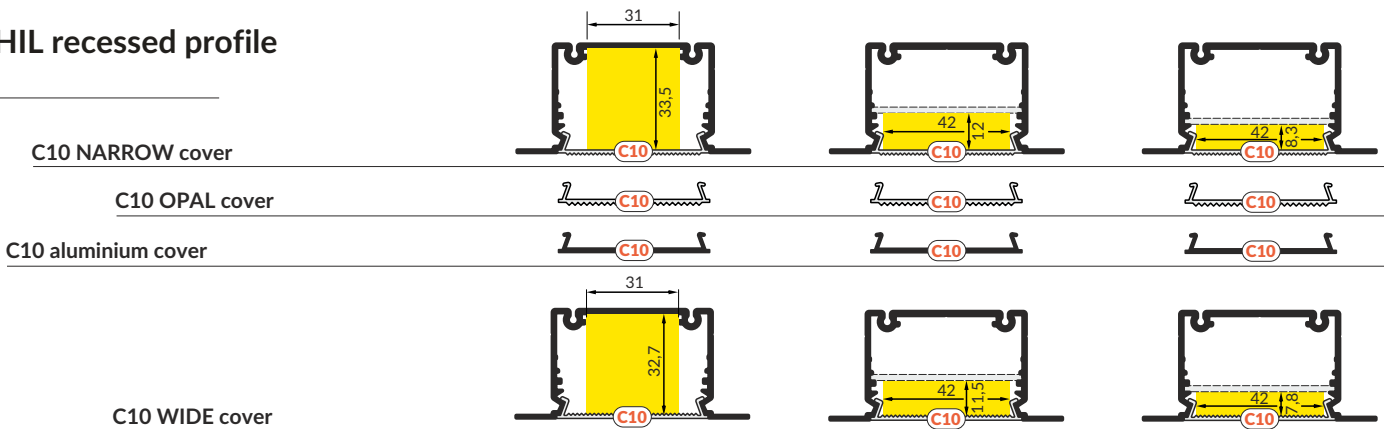

LOWI profile

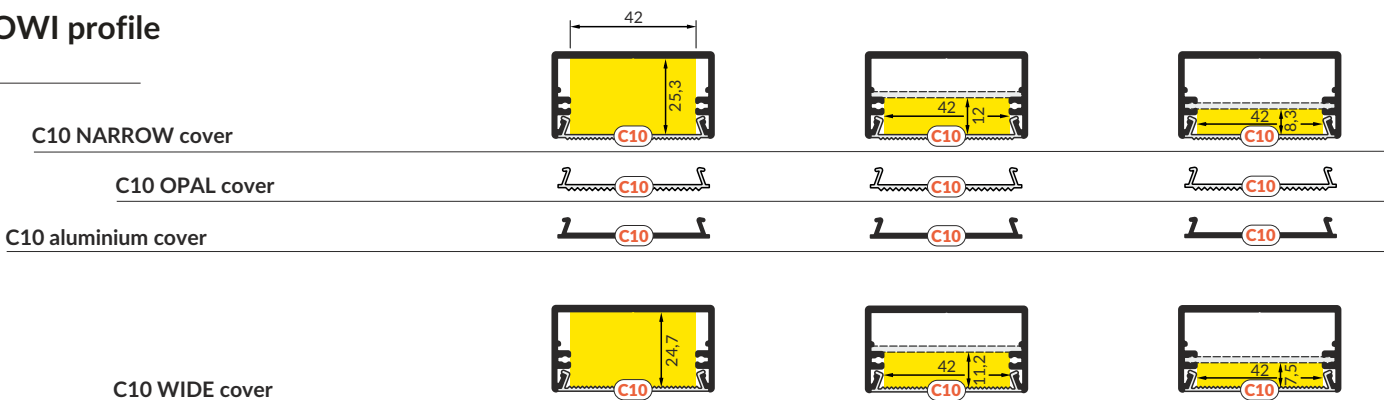

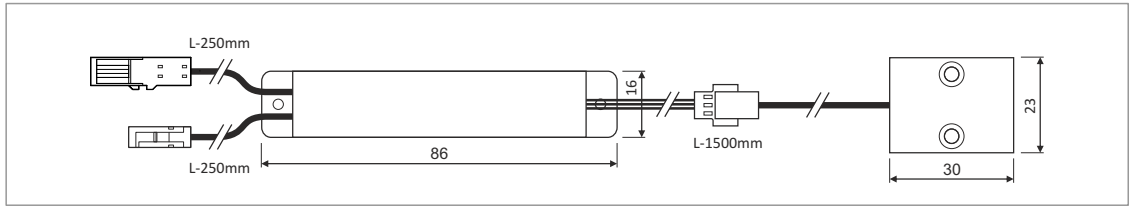

LED switch door operated sensor

15530000

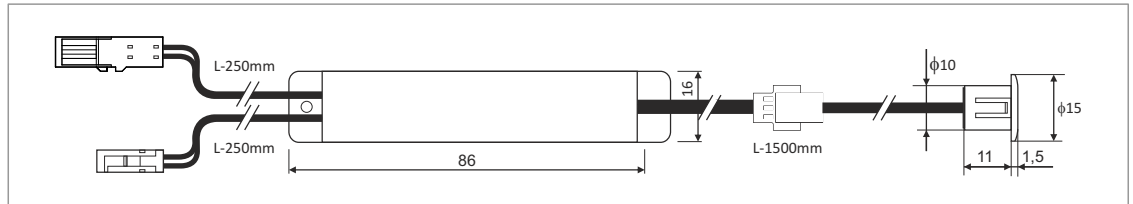

LED switch hand operated sensor

15540000

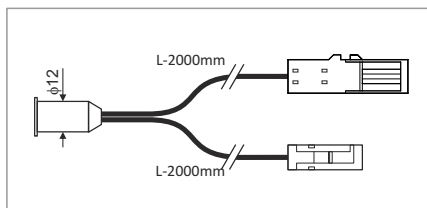

LED switch touch sensor ON/OFF

15630000

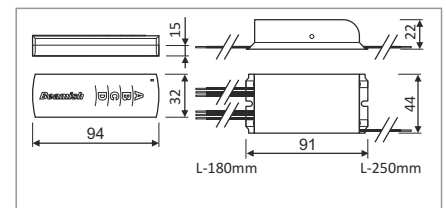

remote controller 3 channel ON/OFF

78530000

lighting controllers and switches



LED switch SU/GR/CO dimmable

53850000



LED switch SU/GR/CO touchless dimmable

53860000

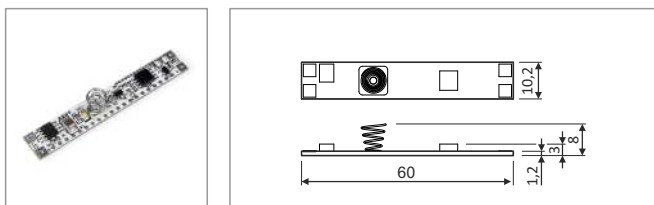

LED switch INSIDE touch dimmable

C5010000

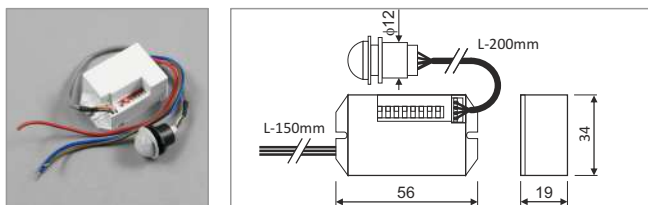

movement sensor YCB1050

85414061

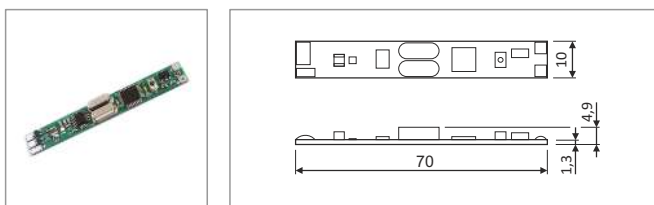

LED receiver basic 1 channel

C5020000

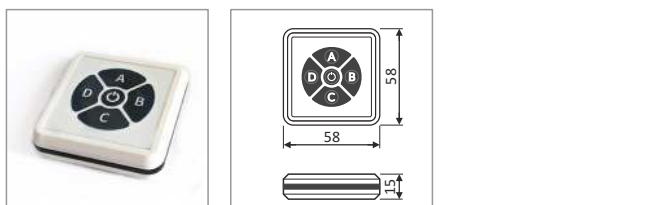

LED remote controller basic 4 channel

C5030000

RGB lighting system

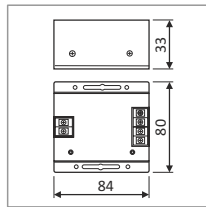

LED receiver RGB 3 channel
12V/24VDC; 216W/432W

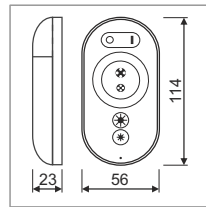

LED remote controller RGB

LED RGB remote controller operates with multiple drivers.

78450000

78460000

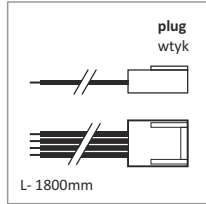

RGB LED cable

4x0,5
1800 mm
1xMIKRO4 plug

67060000

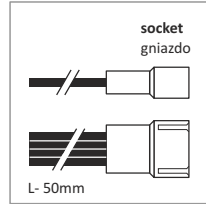

RGB LED cable

4x0,5
50 mm
1xMIKRO4 socket

67050000

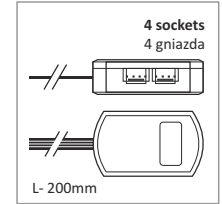

RGB LED distribution box

4x0,5
200 mm
4xMIKRO4 socket

67040000

Vario white lighting system

warm/cold white controllers

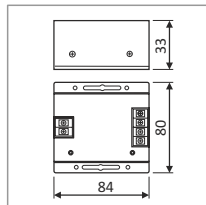

LED receiver warm-cold 2 channel
12V/24VDC; 144W/288W

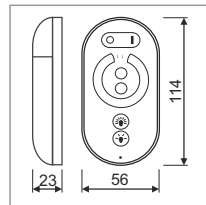

LED remote controller warm-cold

LED remote controller operates with multiple drivers.

78300000

78290000

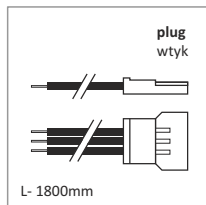

LED cable

3x0,22
1800 mm
1xMIKRO3 plug

67030000

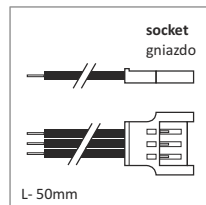
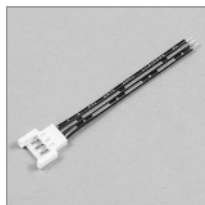

LED cable

3x0,22
50 mm
1xMIKRO3 socket

67020000

LED profile slings

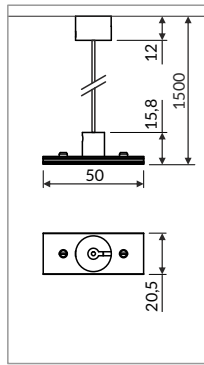

SELV sling 50 V

1500

white

anodized

black

67120001

67120002

67120022

1 set = 2 pcs

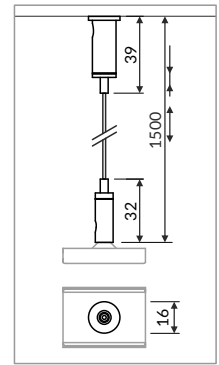

sling for LED mounting

1500

chrome

67140003

1 set = 2 pcs

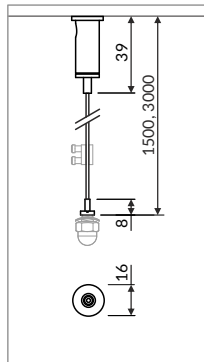

large sling

chrome 1500 mm

chrome 3000 mm

43100003

43110003

1 set = 2 pcs

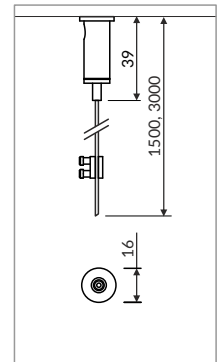

SKB sling

chrome 1500 mm

chrome 3000 mm

67160003

67170003

1 set = 1 pcs

tilted bracket for LED profiles

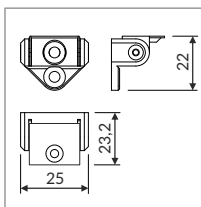

compatible with cone flexible mounting plates:
U4, U6, U, W, Y, Z
mounting plates not included

tilted bracket

white

silver

black

grey

67230001

67230040

67230002

67230022

1 set = 2 pcs

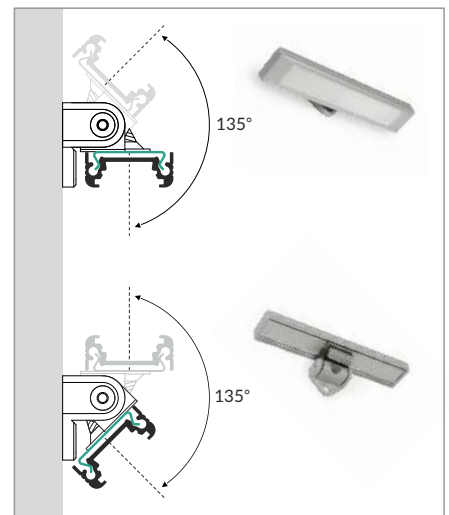

cables, extensions, connectors

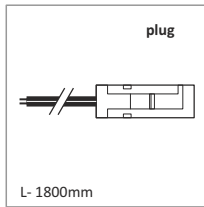

LED cable
2x0,35
1800 mm
1xMINI plug black

85430002

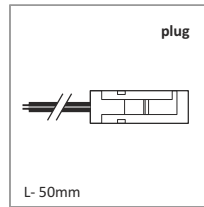

LED cable
2x0,35
50 mm
1xMINI plug I black

85570002

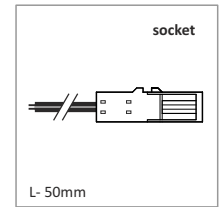

LED cable
2x0,35
50 mm
1xMINI socket black

85580002

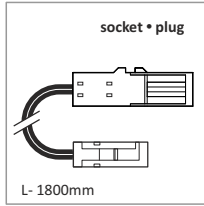

LED extension cable
2x0,35
1800 mm
1xMINI socket
1xMINI plug black

85460002

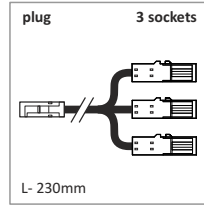

LED cable
2x0,35
230 mm
3xMINI socket
1xMINI plug black

85470002

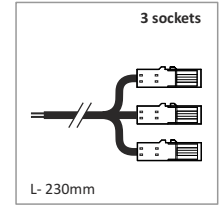

LED cable
2x0,35
230 mm
3xMINI socket black

85590002

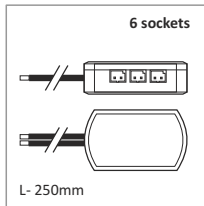

LED distribution box
2x0,5
250 mm
6xMINI socket black

85366900

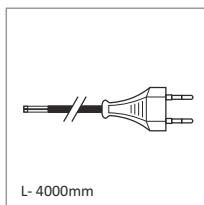

cable
250 V
2x0,75
4000 mm
1xPlug
black
2,5 A

67100002

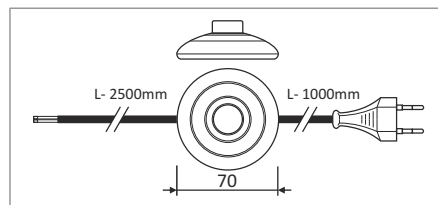

cable with footswitch
250 V
2x0,75
1000/2500 mm
1xPlug
black
2,5 A

67110002

other accessories

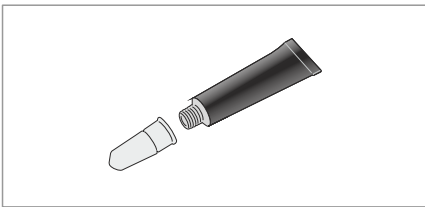

quick-drying adhesive gel
3g



cleaning rubber for anodized surfaces

76640000

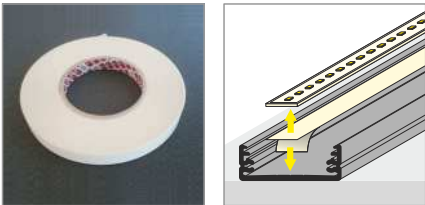

double-sided adhesive thermally conductive tape
15 mm x 50 m

25250000

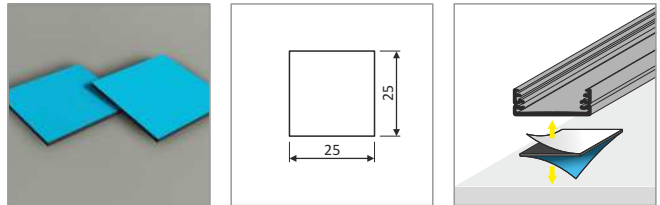

double-sided nonconductive adhesive tape
25 x 25 mm

67990000

1 reel



silicone housing for 8 mm LED strip

76340000

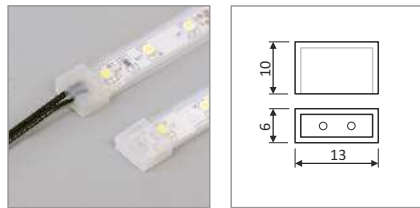

ending for silicone housing for 8 mm LED strip

67980000

67970000s

1 set = 2 pcs (ending with hole, ending without hole) 1

SURFACE

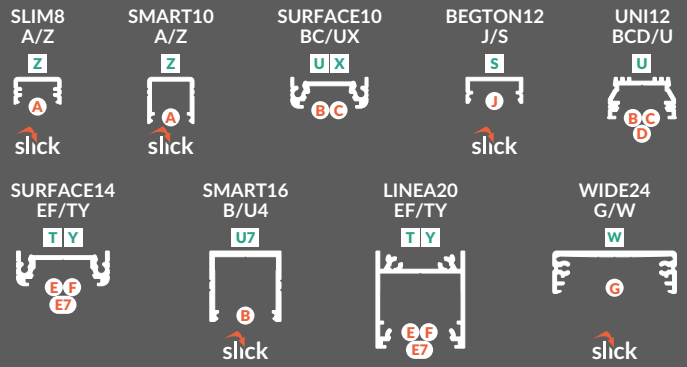

RECESSED

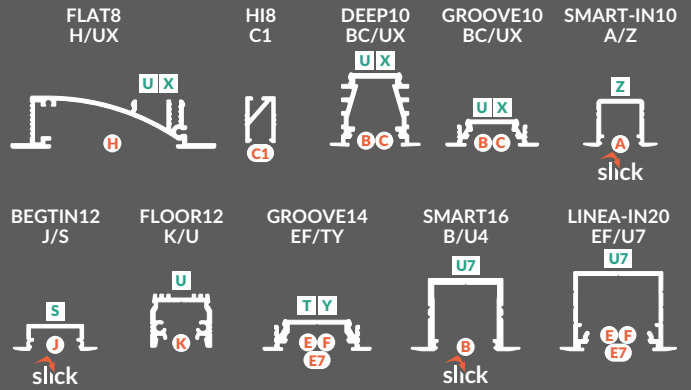

CORNER

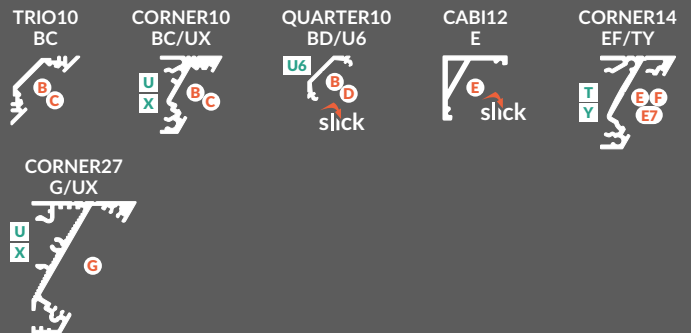

SPECIAL APPLICATION

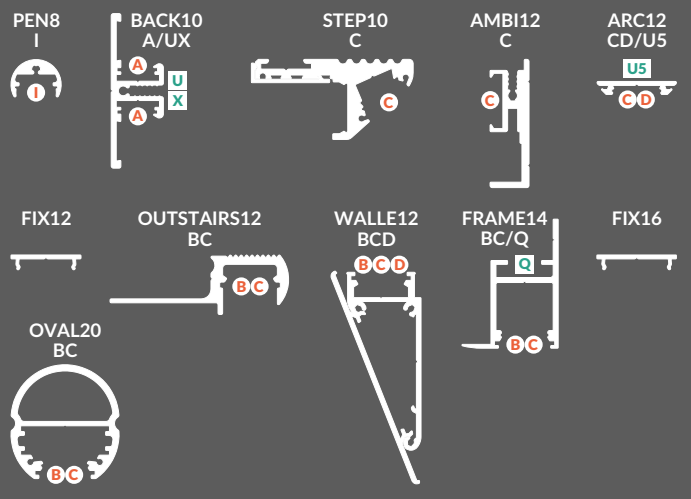

GLASS APPLICATION

